



**Galileo 2 TEK
(G2TEK)
User Manual**



deep down you want the best

scubapro.com

GALILEO 2 TEK (G2TEK) USER MANUAL

The G2TEK dive computer – Designed for technical diving.

Welcome to SCUBAPRO dive computers and thank you for purchasing the G2TEK. You are now the owner of an extraordinary partner for your dives. This manual provides you easy access to SCUBAPRO state-of-the-art technology and the G2TEK's key features and functions. Should you wish to know more about SCUBAPRO diving equipment, please visit our website www.scubapro.com



⚠ IMPORTANT

Before using your SCUBAPRO G2TEK, please carefully read and understand the Read First booklet that is included in the package.

⚠ WARNING

- The G2TEK has a depth rating of 120m/394ft.
- At depths between 115m/377ft and 120m/394ft in dive computer mode the message SWITCHING TO GAUGE appears on the display, and at depths over 120m/394ft the G2TEK automatically switches to Gauge mode and cannot be used as a decompression computer for the remaining time of the dive.
- Diving at oxygen partial pressures higher than 1.6bar (corresponding to a depth of 67m/220ft when breathing compressed air) is extremely dangerous and could lead to serious injury or death.
- Never risk your life on only one source of information. Eventually, every computer has the potential to fail, so do not depend exclusively upon it and always have a plan for how to handle failures. Use a redundant dive computer, carry backup tables and depth/time instrumentation.



Hereby, Uwatec AG declares that the radio equipment type PAN1740 is in compliance with Directive 2014/53/EU.

The combination of SCUBAPRO Galileo 2 TEK and SCUBAPRO high pressure transmitter is a personal protective equipment of category III in compliance with the essential safety requirements of the European Union Regulation 2016/425. The notified body no. 0474, RINA SpA, Via Corsica 12, I-16128 Genoa, Italy, has completed the EC type-examination to the combination mentioned above and assured the conformity with the European Standard EN250:2014. The G2TEK dive instrument is also compliant with the European Union directive 2014/30/EU.

The full text of the EU declaration of conformity is available at www.scubapro.com/declarations-conformity.

Standard EN 13319: 2000

EN13319 is a European diving depth gauge standard. SCUBAPRO dive computers are designed to comply with this standard.

TABLE OF CONTENTS

1.	Introduction to the G2TEK	8
1.1	Power concept and charging	8
1.2	Li-ion Battery Safety Instructions	10
1.3	Operating modes	10
1.4	Switching on the G2TEK	11
1.5	No-Dive warning	13
1.6	No-Fly time	13
1.7	SOS	13
1.8	Emergency information	14
1.9	Owner information	14
1.10	Mounting and pairing the high pressure transmitter	14
1.11	Pairing a pony bottle to the G2TEK	17
1.12	SCUBAPRO Human Factor Diving™	17
1.13	Turning off the G2TEK	17
2.	G2TEK settings and menus	18
2.1	O ₂ settings	20
2.1.1	Recreational (factory setting)	20
2.1.2	Multi-gas (PMG) settings	20
2.1.3	Trimix settings	21
2.1.4	Sidemount settings	21
2.1.5	CCR settings	21
2.1.6	MOD setting	22
2.2	Dive settings	22
2.2.1	Gradient factor	22
2.2.2	Dive mode	23
2.2.3	Safety stop timer	23
2.2.4	ppO ₂ max	23
2.2.5	Water type	23
2.2.6	Nitrox reset time	24
2.2.7	Max surface time	24
2.2.8	OTU settings	24
2.2.9	Desaturation reset	25
2.2.10	All-silent mode	26
2.2.11	Activating Sidemount	27
2.2.12	Activating CCR	27
2.2.13	Activating Trimix	28
2.2.14	Activating PMG	28
2.3	Apnea dive	28
2.3.1	Setting the maximum dual depth alarm	28
2.3.2	Setting the depth incremental warning	29
2.3.3	Setting the dive time interval warning	29
2.3.4	Setting the surface interval warning	29
2.3.5	Low HR alarm	30
2.3.6	Setting the ascent speed alarm	30
2.3.7	Water density	30
2.4	Digital compass	31
2.4.1	Accessing and using the digital compass	31
2.4.2	Auto-off time	33
2.4.3	Declination	33
2.5	Altimeter	33
2.6	Warning settings	34

2.6.1	Maximum dive depth warning	34
2.6.2	CNS O ₂ =75%	34
2.6.3	No-stop time = 2 min	34
2.6.4	Entering deco	35
2.6.5	Maximum dive time warning	35
2.6.6	Tank pressure	35
2.6.7	RBT = 3 min	35
2.6.8	Pressure signal	36
2.6.9	Entering GF stops	36
2.6.10	GF stop ignored	36
2.6.11	GF increased	36
2.6.12	100/100 no stop time = 2 min	37
2.6.13	Enter 100/100 deco	37
2.7	Clock settings	37
2.7.1	Wake-up alarm	37
2.7.2	Time	38
2.7.3	Time zone	38
2.8	Other settings	38
2.8.1	Device information	38
2.8.2	Gas integration	39
2.8.2.1	Tank reserve	39
2.8.2.2	RBT warning or alarm	39
2.8.2.3	Bar graph	39
2.8.2.4	Gas summary	40
2.8.2.5	Pairing	40
2.8.3	Backlight duration	40
2.8.4	Backlight intensity	40
2.8.5	Water contacts	41
2.8.6	Factory settings	41
2.8.7	Feature upgrade	41
2.8.8	Software update	42
2.8.9	Format flash disk	42
2.9	Pair Digital Heart Rate Monitor	43
2.10	Personalization	43
2.10.1	Screen configuration	43
2.10.2	Language	43
2.10.3	Start-up picture	44
2.10.4	Setting the user preferred units	44
2.10.5	Show owner info	44
2.10.6	Emergency info	44
2.10.7	Display color	45
2.11	Pictures	45
2.12	Dive planner	45
2.12.1	No-stop plan	45
2.12.2	Decompression plan	46
2.13	Bluetooth	46
2.14	Logbook	47

3.	Diving with the G2TEK	49
3.1	Dive mode at surface	49
3.1.1	Recreational (factory setting)	49
3.1.2	Display configuration in PMG mode	50
3.1.3	Display configuration in Trimix mode	50
3.1.4	Display configuration in Sidemount mode	50
3.1.5	Display configuration in CCR mode	50
3.1.6	Surface interval, no dive and CNS% counters	50
3.2	Button functions while diving	51
3.3	Altitude diving	54
3.3.1	Altitude classes and altitude warnings after a dive	54
3.3.2	Altitude and the decompression algorithm	54
3.3.3	Prohibited altitude	55
3.3.4	Decompression dives in mountain lakes	55
3.4	Diving with nitrox	56
3.4.1	Technical diving	57
3.4.2	Diving with multiple gas mixtures	58
3.4.3	Diving with Trimix mode	62
3.4.4	Diving with Sidemount mode	64
3.4.5	Diving with CCR mode	64
3.5	Warnings and alarms	66
3.5.1	Warning settings	66
3.5.2	Maximum depth	66
3.5.3	CNS O ₂ = 75%	66
3.5.4	No-Stop time = 2 min	66
3.5.5	Entering decompression	67
3.5.6	Dive time	67
3.5.7	Tank pressure	67
3.5.8	RBT = 3 min	67
3.5.9	Pressure signal	68
3.5.10	Entering GF stops	68
3.5.11	GF stop ignored	68
3.5.12	GF increased	69
3.5.13	GF no-stop = 2 min	69
3.5.14	Entering decompression at 100/100	69
3.6	Alarms	69
3.6.1	Ascent rate	70
3.6.2	MOD/ppO ₂	71
3.6.3	CNS O ₂ = 100%	71
3.6.4	Tank reserve pressure reached	72
3.6.5	Missed decompression stop	72
3.6.6	RBT = 0 min	72
3.6.7	Low battery	73
3.7	Display information	73
3.7.1	Display configuration during the dive	74
3.7.2	Setting bookmarks	77
3.7.3	Stop watch timer	77
3.7.4	Safety stop timer	77
3.7.5	Backlight	77
3.7.6	Compass	77
3.8	Diving with GF settings	78
3.9	Gauge mode	78
3.10	Apnea mode	79

4. G2TEK accessories	80
4.1 Bungee arm strap	80
4.2 Wireless high pressure transmitter	80
4.3 Digital Heart Rate Monitor	81
4.4 Bluetooth USB stick	81
5. Interfaces for the G2TEK	82
5.1 USB connection	82
5.2 Bluetooth connection	84
6. Introduction to Logtrak	84
6.1 LogTRAK desktop version	84
6.1.1 Download dive profiles	85
6.1.2 Changing warnings/settings on the G2TEK, and reading computer info ..	85
6.1.3 Owner and emergency information	85
6.1.4 Personalization	85
6.1.5 User info	85
6.2 SCUBAPRO LogTRAK 2.0 mobile application	86
7. Taking care of your G2TEK	86
7.1 Technical information	86
7.2 Maintenance	87
7.3 Replacing the battery the high- pressure transmitter	87
7.4 Replacing the battery in the Digital Heart Rate Monitor	88
7.5 Warranty	88
8. Compliance	89
8.1 CE regulatory notices	89
8.1.1 EU Radio Equipment Directive	89
8.1.2 EU Personal Protective Equipment Regulation	89
8.1.3 EU Depth Gauge Standard	89
8.1.4 EU Electromagnetic Compatibility Directive	89
8.1.5 EU Declaration of Conformity	89
8.2 FCC & ISED regulatory notices	89
8.2.1 Modification Statement	89
8.2.2 Interference Statement	89
8.2.3 Wireless Notice	89
8.2.4 FCC Class B Digital Device Notice	90
8.2.5 CAN ICES-3 (B) / NMB-3 (B)	90
8.3 Date of manufacture	90
8.4 Manufacturer	90
9. Glossary	91

The G2TEK is a technologically-advanced instrument that can accompany you during your underwater adventures while providing you with accurate depth, time and decompression information.

Your G2TEK User Manual is divided into 6 main sections.

Introduction to the G2TEK. This section provides an overview of the G2TEK computer and describes its operating modes and main functions when on the surface.

G2TEK settings and menus. This section goes through the settings of your G2TEK.

Diving with the G2TEK. This section takes you underwater with the G2TEK, showing you how to use the G2TEK as a dive computer. It outlines everything the G2TEK can—and will—do to enhance your safety and fun underwater.

G2TEK accessories. This section briefly describes the G2TEK's extras that you can purchase to get the most out of your dive computer in all conditions.

Interfaces for the G2TEK. This section describes the two interfaces that connect the G2TEK to the desktop and mobile devices. It describes how to change settings, how to download and how to manage your logbook.

Introduction to LogTRAK. This section briefly describes how to enter owner and emergency information, how to change settings on your dive computer, how to download and how to manage your logbook with LogTRAK desktop and mobile apps.

Taking care of your G2TEK. This section illustrates how to take care of your new dive computer.

1. INTRODUCTION TO THE G2TEK

1.1 Power concept and charging

The G2TEK is powered by a rechargeable Li-Ion battery. SCUBAPRO recommends fully charging the battery before using the computer for the first time.

To charge the battery, plug the USB cable, that is included in the packaging, into your G2TEK as shown in the picture below.

NOTE: a USB power adapter is not included with the product.

WARNING

Only use the cable provided with your G2TEK to charge it!

Then, connect the other end of the cable to a USB power adapter, or a USB device capable of providing power for charging. At this point, the following battery charging status symbols will appear on the display of the G2TEK.

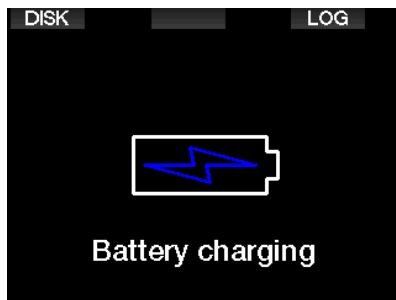

NOTE: If the G2TEK's battery is deeply discharged, nothing will appear on the display screen until the battery has reached a safe charge level for a startup. If this occurs, do not disconnect the USB, and do not try to activate the G2TEK by pressing a button. Simply leave the G2TEK charging for at least half an hour.

Charging will continue, but the above display will switch off after 3 minutes. When the battery is completely charged, the following display will appear.

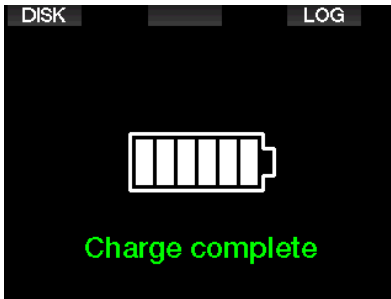

The G2TEK will alert you when the battery is approaching a critical discharge level by displaying the following message.

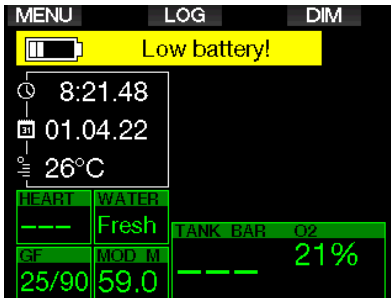

In addition, the battery icon with current charging status is shown above the main time-of-day display.

⚠ WARNING

During the dive, when the battery charge level indicator falls to only 1 segment, the display will switch off automatically to save energy. However, you can still check the display manually by pressing the right button.

⚠ WARNING

The G2TEK will not start a dive when the battery has reached the critical discharge level indicated by the warning: "Charge battery!" In this state you cannot use the G2TEK for diving.

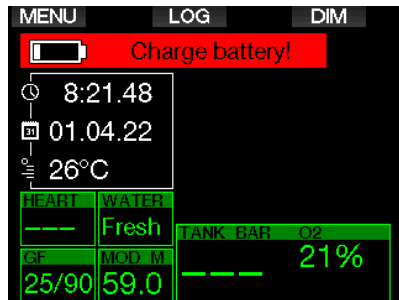

⚠ WARNING

Starting the dive with a weak battery may lead to a situation where the G2TEK shuts off during the dive. In case of such an event you should always carry a backup instrument that will enable you to complete the dive safely. If the G2TEK switches off during a dive it will remain locked in Gauge mode for 48 hours. (For more information on Gauge mode operation, see chapter: **Gauge mode**.)

👉 *NOTE: Storing the G2TEK with a low battery may lead to a deep discharge state, which shortens the life of the battery.*

1.2 Li-ion Battery Safety Instructions

WARNING

Failure to read, and follow Li-ion battery safety instructions, and warnings may result in fire, personal injury, and property damages if the battery is charged and/or used improperly.

- DO NOT SHORT CIRCUIT. Short circuits may cause a fire and injury!
- Charge battery fully before first use.
- To charge the battery use only the specifically designed USB charger, provided in the packaging.
- Do not keep a bare battery in your pocket, purse, or anywhere together with other metal (conductive) objects.
- If the battery is damaged in any way stop using the dive computer immediately.
- Do not immerse in any liquid or allow the battery to get wet.
- Do not place the battery in high-pressure containers, microwave ovens, or on induction cookware.
- Immediately discontinue use if, while using, charging or storing, the battery emits an unusual smell, feels hot, changes color or shape, or appears abnormal in any other way.
- Do not carry, or store the batteries together with any conductive metal objects.
- Do not expose the battery to excessive sunlight or heat.
- Do not disassemble, or modify the battery.
- Keep the battery away from children, and pets.
- Never charge, or store the batteries inside your car in extreme temperature. Extreme temperatures (low or high) might ignite the battery, and cause a fire.
- Do not connect positive, and negative battery contacts intentionally, or unintentionally.
- Do not reverse the positive (+) and

negative (-) terminals when charging, or using the battery.

- Never charge the battery at a current exceeding manufacturer-specified charging current.
- Never completely discharge the Li-ion battery.
- After the battery is discharged, don't leave it discharged. Charge battery as soon as possible
- It is your responsibility to determine that your charger and host device work properly.
- On battery electrolytes exposure to skin, flush with water immediately.
- If eye exposure occurs, flush with water for 15 minutes, and seek emergency care immediately.
- When your Li-ion battery reaches the end of its lifetime, it can only be replaced by an authorized SCUBAPRO service center. Do not open your dive computer or try to replace the battery yourself!

1.3 Operating modes

The G2TEK has 4 operating modes:

- **Charging and USB communication mode.** When connected to a USB device the G2TEK's battery automatically starts charging. At the same time, you can access either the flash memory or the logbook using the LogTRAK program.
- **Sleep mode.** In this mode the display is off, but the G2TEK still updates desaturation and monitors ambient pressure for altitude changes, etc. This mode is activated automatically at the surface after 3 minutes without operation.
- **Surface mode.** After a dive or when manually activated, the display is on and you can change settings or operate the G2TEK with its buttons. The Bluetooth interface can be activated in this mode.
- **Dive mode.** This mode is activated when the computer reaches a depth of 0.8m/3ft or more. In this mode the G2TEK monitors depth, time,

temperature and wireless sensors. Decompression calculations are performed in this mode.

1.4 Switching on the G2TEK

To switch on the G2TEK, press the right button.

 **NOTE:** You cannot turn the G2TEK on when it is connected to USB.

The initial activation of your G2TEK will require some basic set up (selecting language, setting the time, etc.). The G2TEK will guide you through them. Simply follow the screen prompts while using the buttons.

 **NOTE:** The following basic setup will also be required if you reset the G2TEK with the menu **8.6. Factory settings**.

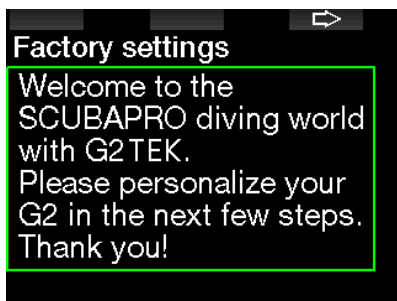

Press the right button.



Select your language with the left or middle button. Then confirm your selection with a press of the right button.

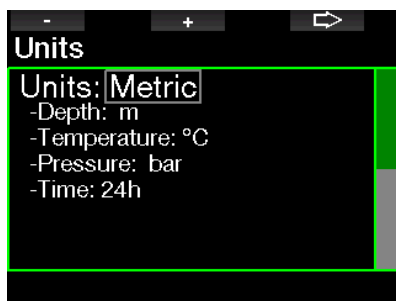

Select each unit with the left or middle button, and confirm it with the right button.

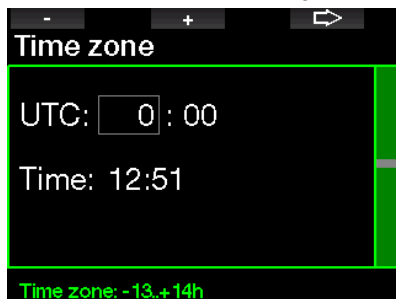

Set the time zone with the left or middle button and confirm it with the right button.

After this initial setup, your G2TEK will boot to the so-called main **time-of-day** display. This is the display in which the current time is shown in the main field.

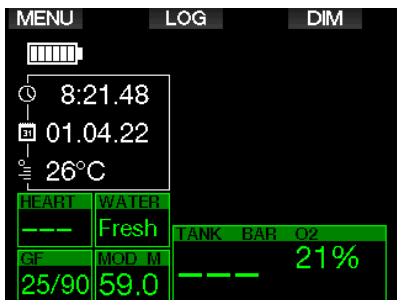

Your G2TEK's button functions can be found on-screen. To illustrate, the screen above shows that pressing the left button will take you to the main menu, pressing the middle button will take you to the logbook

and pressing the right button will dim the display light.

However, be aware that these function labels may change depending on the operational mode you're currently in.

NOTE: There are two methods for pressing the G2TEK's buttons:

1. "Short" press. This is the normal method used in most cases with the labelled functions.
2. "Press-and-hold." This method is used only in special cases. They are described in this manual but are not labelled on the screen.

Button functions at the surface are summarized in the following table.

	LEFT BUTTON		MIDDLE BUTTON		RIGHT BUTTON	
	Press	Press and hold	Press	Press and hold	Press	Press and hold
GAUGE, SCUBA	Main menu	Oxygen setting	Logbook	Gas summary table / Pictures Pictures	Backlight	Compass
APNEA	Main menu	Manual start of an immersion	Logbook	Pictures	Backlight	Compass

1.5 No-Dive warning

If the G2TEK detects a situation of increased risk (due to potential microbubble accumulation from previous dives or a CNS O₂ level above 40%), the **NO DIVE** symbol will appear to advise you against performing another dive right away. The suggested time interval that you should wait prior to diving again is shown on the dive mode display, adjacent to the \emptyset symbol.



You should not undertake a dive as long as the no-dive warning is displayed on the dive computer's screen. If the warning is prompted by microbubble accumulation (as opposed to CNS O₂ over 40%) and you dive anyway, you will have shorter no-stop times or longer decompression times. Moreover, the duration of the microbubble warning at the end of the dive can increase considerably.

1.6 No-Fly time

The **no-fly time (NO FLY)** is the time during which an exposure to the reduced pressure (equal to ascending at higher altitudes) inside the cabin of an airplane could cause decompression sickness, as calculated by the decompression model in the computer. The no-fly text with countdown timer is shown until the restriction is completed. To learn more about altitude warnings and altitude diving, see chapter: **Altitude diving**.

⚠ WARNING

Flying while the G2TEK displays the **NO FLY** symbol and countdown timer can result in serious injury or death.

1.7 SOS

If you stay above a depth of 0.8m/3ft for more than 3 minutes without observing a mandatory decompression stop, the G2TEK will switch into **SOS** mode. Once in **SOS** mode the G2TEK will lock up and will be inoperable as a decompression dive computer for 24 hours if it was diving in Scuba mode. If it is used for diving within the 24 hours of an **SOS** lock, it will automatically switch to Gauge mode and provide no decompression information.

👉 *NOTE: In Gauge mode the SOS lock interval is 48 hours.*

⚠ WARNING

- Violating a mandatory decompression obligation may result in serious injury or death.
- Serious injury or death may result if a diver does not seek immediate treatment should any signs or symptoms of decompression sickness occur after a dive.
- Do not dive to treat symptoms of decompression sickness.
- Do not dive when the computer is in **SOS** mode.

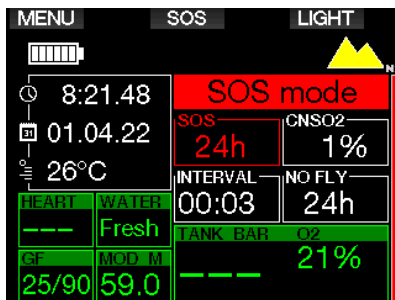

The display shows the same information as when displaying desaturation but, in addition, the SOS mode message is displayed.

Instead of the no-fly time, the 24-hour countdown is shown. The middle button description changes from **LOG** to **SOS**, and by pressing it an emergency message is displayed. The emergency information for this display can be entered using LogTRAK. Once the emergency message is displayed, pressing the **LOG** button shows the details of the last dive.

NOTE: If the battery becomes fully discharged while at depth in spite of using the power save mode, the G2TEK will remain in SOS mode and locked into Gauge mode for 48 hours, independent of the remaining desaturation time.

1.8 Emergency information

To add your emergency information you will need to use LogTRAK for Windows or Mac. See section: **Introduction to LogTRAK**.

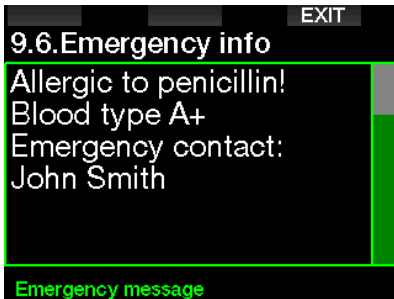

1.9 Owner information

To customize your time-of-day display with your name or other text you need to use LogTRAK. See section: **Introduction to LogTRAK**.

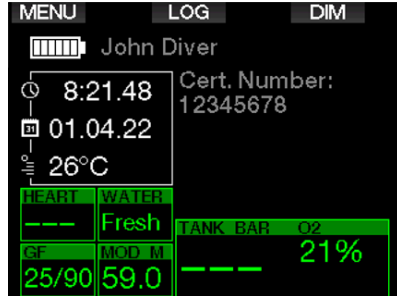

NOTE: In the event you misplace your G2TEK, it is advisable to include some contact information along with your owner information.

1.10 Mounting and pairing the high pressure transmitter

The G2TEK can receive tank pressure information from multiple Smart series high pressure transmitters. Each transmitter needs to be mounted on a high pressure port of a first stage regulator.

To mount the transmitter, first remove the high pressure port plug from the first stage regulator, then screw the transmitter in place.

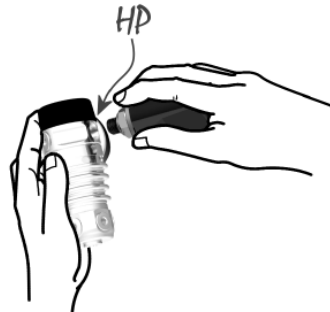

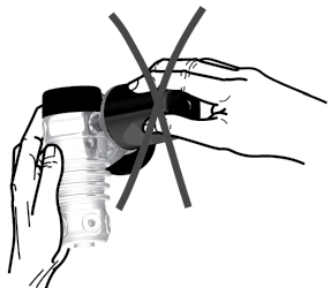

☞ **NOTE:** Use an appropriate wrench to tighten the transmitter. Take care to not overtighten.

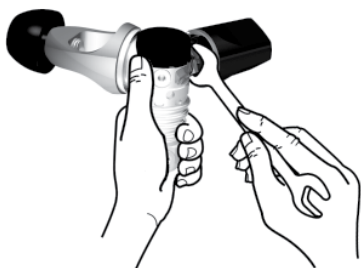

The Smart transmitter communicates via radio frequency with the G2TEK. For optimal transmission performance, we recommend positioning the transmitter as described in the pictures below.

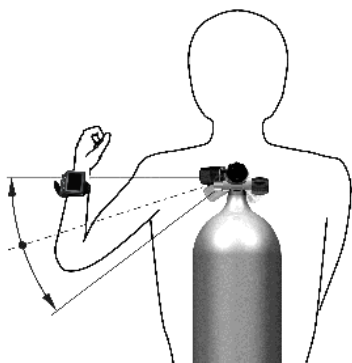

Transmitter position for the left hand.

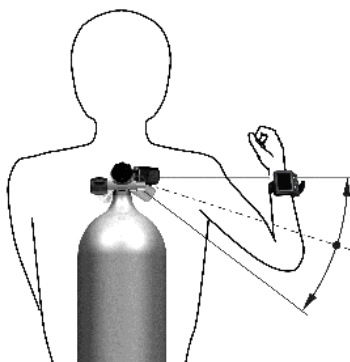

Transmitter position for the right hand.

In order for the G2TEK to display the pressure signal from a Smart transmitter, a coded, interference-free line of communication must first be established. This step needs to be performed only once for each transmitter.

There are two methods for pairing the G2TEK to a transmitter.

1. For automatic pairing, proceed as follows:

- Mount the first stage regulator with the Smart transmitter on a full tank.
- Turn on the G2TEK, ensure it is in the time-of-day display, and place it near (x) the transmitter as indicated in the picture below.
- Open the tank valve.

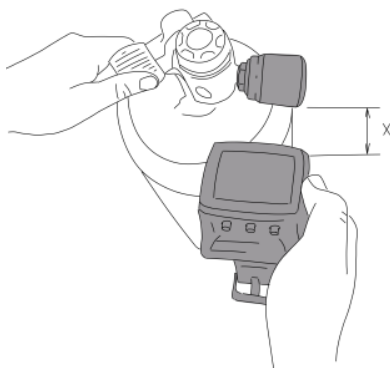

2. For manual pairing, proceed as follows:

- Mount the first stage regulator with the Smart transmitter on a full tank.

- Turn on the G2TEK, select menu **8.2.5. Pairing.**
- Open the tank valve.

Upon pressurization, the Smart transmitter will send a pairing sequence to the G2TEK. When the G2TEK receives this information, the display changes to show a listing of tank designations. (**T1**, **T2**, etc.).

Tank **T1** is always the main tank you start your dive with. Other tanks are used when diving with more than one gas mixture (described in chapter: **Diving with multiple gas mixtures**).

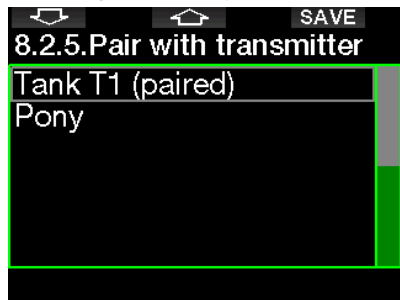

Use the ARROW buttons to select the tank that you want to assign to the transmitter, then press SAVE to lock in your selection. The G2TEK will confirm the pairing with the message **PAIRING TO T1 SUCCESSFUL**.

If you do not wish to complete the operation, with a press-and-hold of the right button the G2TEK will show the message **PAIRING CANCELLED**. The pairing will also be cancelled if you do not press SAVE within 3 minutes of tank selection.

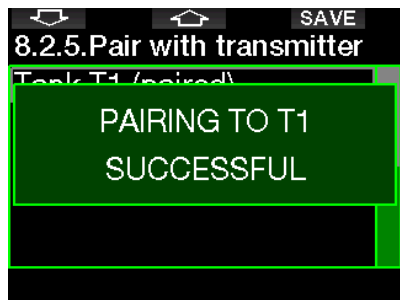

NOTE: The transmitter must have been unpressurized for at least 40 seconds prior to performing the

pairing operation; otherwise it will not transmit the pairing sequence.

Also, a transmitter can only be paired to one tank designation. If you pair the same transmitter to a second tank designation, the first one will be erased. However, you can pair more than one G2TEK to the same transmitter.

After a successful pairing of T1 to the G2TEK, the display will show the tank pressure in either BAR or PSI. If tank T1 has not been paired, the G2TEK will show NO P instead of a pressure value.

If T1 has been paired but the G2TEK is not receiving any signal, it will show - - - instead of a pressure value.

On the surface, the status of tanks T2, T3, etc. are shown in the gas summary table, described in chapter: **Gas summary**.

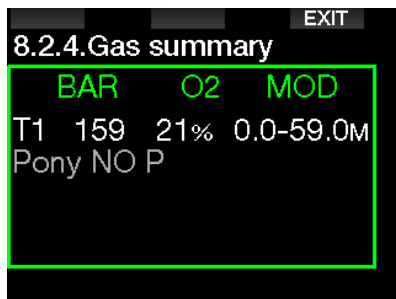

NOTES:

- The Smart transmitter has a range of approximately 1.5m/5ft.
- To maximize the life of the battery, the transmitter operates at a low update rate when there is no pressure change for more than 40 seconds. The transmitter also turns itself off when the pressure is 14bar/200psi or less.
- If a transmitter battery is weak, the G2TEK will alert you with a screen message displaying the tank assigned to that transmitter as shown on the screen below.

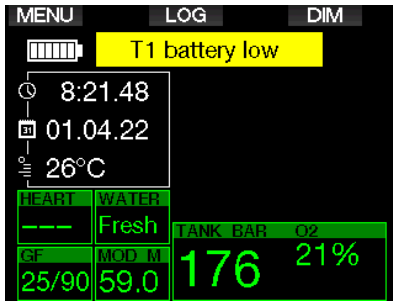

See chapter: **Replacing the battery in transmitter** for information on how to replace the transmitter battery.

1.11 Pairing a pony bottle to the G2TEK

A pony bottle is a small diving cylinder which is fitted with an independent regulator, and carried by a diver as an extension to the scuba set. In an emergency, such as depletion of the diver's main air supply, it can be used as an alternative air source or bailout bottle to allow a normal ascent in place of a controlled emergency swimming ascent.

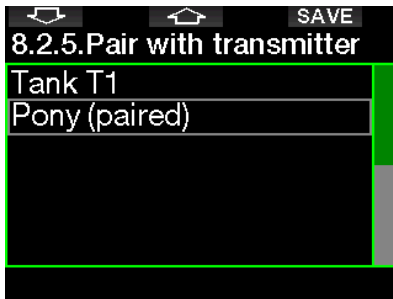

The pony bottle can be paired the same way as a normal cylinder from the G2TEK's **8.2.5 Pairing** menu.

1.12 SCUBAPRO Human Factor Diving™

The G2TEK has patented underwater Heart Rate, Skin Temperature and Breathing monitors. These features will provide you with more data that enhances your diving experience and helps you to become a more advanced diver.

To learn more about the physiology of the SCUBAPRO Human Factor Diving™, see the booklet: "HEARTRATE MEASUREMENT FOR BETTER WORKLOAD ASSESSMENT," Dr. T. Dräger, Dr. U. Hoffmann, 2012, www.scubapro.com.

NOTE: In the G2TEK the Heart Rate and Skin Temperature do not adapt the algorithm but are for monitoring only.

1.13 Turning off the G2TEK

The G2TEK turns off automatically after 3 minutes without active use, or without an active Bluetooth link. When in the time-of-day display, you can turn the G2TEK off manually with a press-and-hold of both right and left buttons simultaneously.

2. G2TEK SETTINGS AND MENU

By pressing MENU from the time-of-day display you will enter the Settings folder. Note that when you first reach a menu, you are “outside” of it. Therefore, you must press the ENTR button to get inside the actual menu. Some menus have multiple levels. You can return to previous levels with a press-and-hold of the ENTR button. Also, you can return to time-of-day display by press-and-hold both right and left buttons simultaneously.

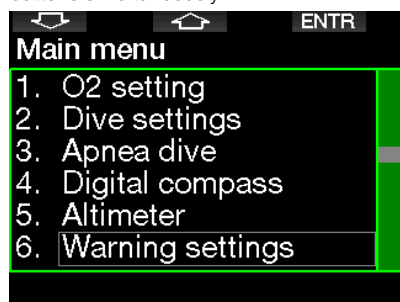

Simply, by pressing ARROW buttons you can surf the menu, and by pressing ENTR you get into the menu selection. For menus with multiple items there is an indicator bar on the right side of the screen which shows your current location.

Regardless of the language setting, all menus are numbered for easy identification. All of the sub menu function in a similar way, meaning that if there is a value that can be changed, the range will be shown at the bottom of the screen (see screen below). Sub menus are also numbered using the decimal format x.y (x=main menu, y=sub menu).

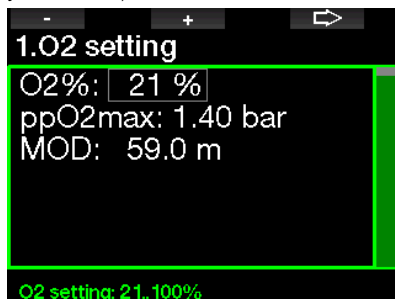

In this case, left and middle button functions are labeled – and + (enabling you to edit the current selection). The right ARROW button moves your selection to the next field and SAVE stores the entered values. On the right side of the screen a navigation bar indicates the value as an analog meter.

The Main menu offers the following settings:

Nr.	Menu	Nr.	Menu
1	O ₂ setting	6.9.	Entering GF stops
2	Dive settings	6.10.	GF stop ignored
2.1.	Gradient factor	6.11.	GF increased
2.2.	Dive mode	6.12.	100/100 ND = 2min
2.3.	Safety stop timer	6.13.	Enter 100/100 deco
2.4.	ppO ₂ max	7	Clock settings
2.5.	Water type	7.1.	Wake-up alarm
2.6.	Nitrox reset time	7.2.	Time
2.7.	Max surface time	7.3.	Time zone
2.8.	OTU settings	8	Other settings
2.9.	Desaturation reset	8.1.	Device information
2.10.	All-silent mode	8.2.	Gas integration
2.11.	Sidemount	8.2.1.	Tank reserve
2.12.	CCR	8.2.2.	RBT = 0 min
2.13.	Trimix	8.2.3.	Bar graph
2.14.	PMG	8.2.4.	Gas summary
3	Apnea dive	8.2.5.	Pairing
3.1.	Maximum depth	8.3.	Backlight duration
3.2.	Depth increment	8.4.	Backlight intensity
3.3.	Dive time interval	8.5.	Water contacts
3.4.	Surface interval	8.6.	Factory settings
3.5.	Low heart rate	8.7.	Feature upgrade
3.6.	Ascent speed	8.8.	Software update
3.7.	Water density	8.9.	Format flash disk
4	Digital compass	8.10	Pair D-HR belt
4.1.	Use compass	9	Personalization
4.2.	Auto-off time	9.1.	Screen configuration
4.3.	Declination	9.2.	Language
5	Altimeter	9.3.	Start-up picture
6	Warning settings	9.4.	Units
6.1.	Maximum depth	9.5.	Show owner info
6.2.	CNSO ₂ = 75%	9.6.	Emergency info
6.3.	No-stop = 2min	9.7.	Display color
6.4.	Entering deco	10	Pictures
6.5.	Dive time	11	Dive planner
6.6.	Tank pressure	12	Bluetooth
6.7.	RBT = 3min	13	Logbook
6.8.	Pressure signal		

By surfing these menus you can quickly become familiar with them. Following are short descriptions for each selection.

NOTE: To make it easier to understand the menu system in accordance with your current level of diving, the G2TEK has a feature upgrade function. More advanced level functions and selections do not appear in the menu unless you want them to. (This is why you might find some menu numbers missing from the MAIN menu screen.)

For example, if you are not diving with rebreathers or using more than one gas, it's not necessary to enable the CCR or PMG menu modes. This keeps the menu system simple and streamlined to suit your particular diving style.

2.1 O₂ settings

Here you can change the gas content of the tanks that you are using as well as the partial pressure limit of the gas. The Maximum Operating Depth (MOD) limit will be shown for the values that you have selected. To learn more about diving with Nitrox and MOD, see chapter: **Diving with nitrox**.

2.1.1 Recreational (factory setting)

For normal one-tank diving you can select a gas mix from 21% oxygen (Air) up to 100% oxygen. The ppO₂ max value is required for the MOD limit you intend to use for this gas. The factory setting is 1.40bar.

WARNING

The MOD limit defines the warning depth based on oxygen toxicity. However, depth narcosis can affect a diver's skills much earlier, jeopardizing his or her ability to dive safely at that depth.

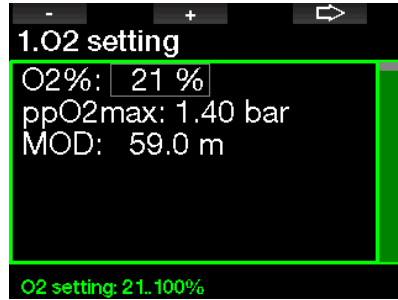

2.1.2 Multi-gas (PMG) settings

If PMG is enabled, the O₂ setting will appear as follows. See chapter: **Activating PMG** to learn how to activate this feature.

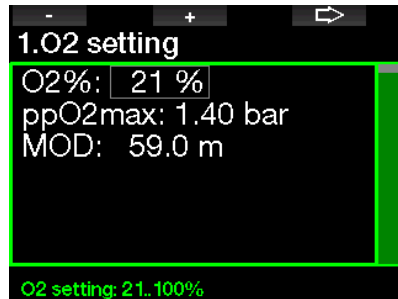

T1 is always the default gas at the start of the dive. Tank 2 through 8 values can be adjusted the same way as Tank 1.

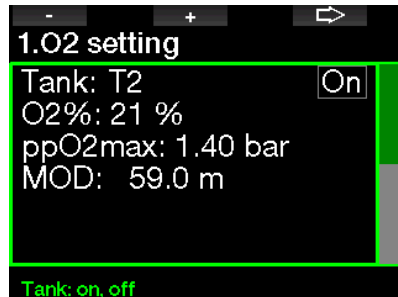

You can set a different ppO₂ setting for decompression gases.

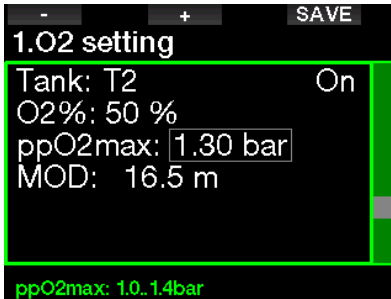

The maximum ppO₂ limit can be modified at menu **2.4. ppO₂max**.

NOTE: See chapter: **Diving with multiple gas mixtures** to learn more about this feature.

2.1.3 Trimix settings

If trimix is enabled the O₂ setting will appear as follows. See chapter: **Activating Trimix** to learn how to activate this feature.

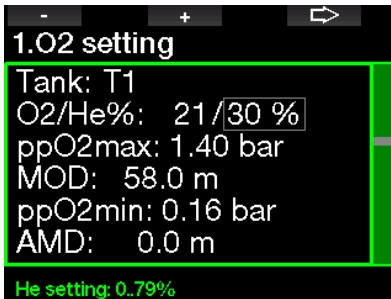

In trimix mode the oxygen fraction can be selected from 8% to 100%.

NOTE: See chapter: **Diving with Trimix mode** to learn more about this feature.

NOTE: To ensure an adequate supply of oxygen to the body, the gas used at the beginning of the dive must contain enough oxygen (you can use a travel mix or one of the decompression gases). Since the dive always starts with tank T1, the minimum O₂ setting for tank T1 is 18%.

WARNING

The Absolute Minimum Depth (AMD) depends on ppO₂min value. If the alarm depth is shallower than 0.8m/3ft which is the dive start depth for the G2TEK, the alarm will not activate before a 0.8m/3ft depth is reached! This situation is dangerous and may lead to death by drowning.

WARNING

Engaging in heavy work while at the surface or at shallow depths while breathing less than a 21% oxygen (hypoxic mix) fraction may cause a loss of consciousness and lead to drowning.

2.1.4 Sidemount settings

In Sidemount mode the O₂ settings can be adjusted the same way as in PMG mode. See chapter: **Multi-gas (PMG) settings** to learn how to set the oxygen content in this mode.

2.1.5 CCR settings

If the CCR mode is enabled the diluent tank will appear as follows. Other tanks (T1 to T8) can be configured as with PMG mode. See chapter: **Activating CCR** to learn how to activate this feature.

Setpoint 1 can be selected from 0.2 to 0.95bar which defines the MOD.



Setpoint 2 can be selected from 1.0 to 1.6bar. Since higher values cannot be reached at the surface, an AMD will be calculated for the setting.

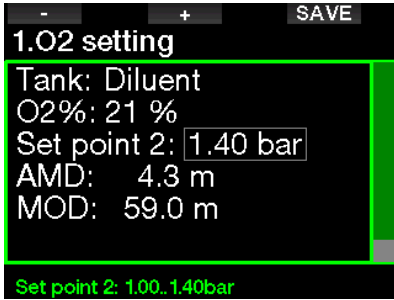

☞ NOTE: See chapter: **Diving with CCR mode** to learn more about this feature.

2.1.6 MOD setting

It is possible to disable the MOD setting (- - - shown in the field) like on the screen below.

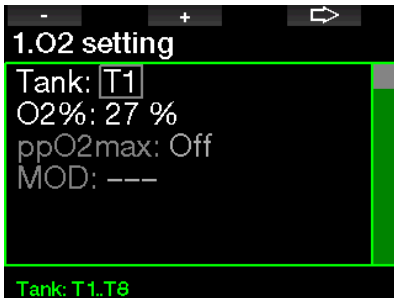

This requires entering the safety code 313 in the menu **2.4. ppO₂ max.**

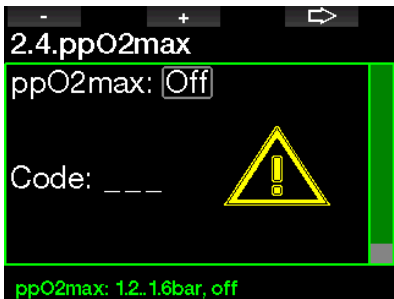

⚠ WARNING

Diving with a ppO₂ higher than 1.4bar is dangerous and may lead to unconsciousness, drowning and death.

☞ NOTE: the ppO₂ is fixed to 1.6bar when the selected oxygen content is 80% or higher.

2.2 Dive settings

2.2.1 Gradient factor

Here you may select the preferred Gradient Factor setting that you want to follow during your dives. GF low can be set from 5 to 100 and GF high from 50 to 100.

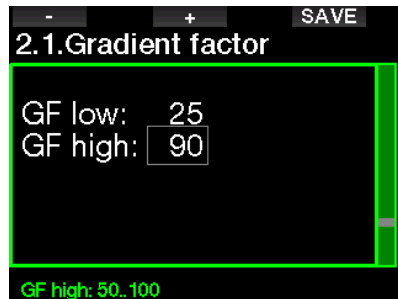
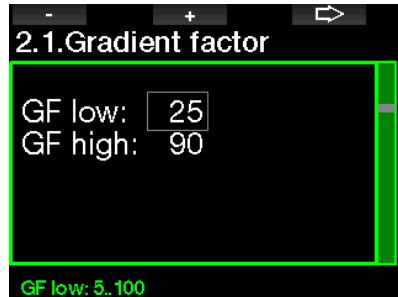

☞ NOTE: For more about diving with the GF, see chapter: **Diving with GF settings.**

2.2.2 Dive mode

Your G2TEK allows you to choose between Scuba, Gauge and Apnea modes. When the G2TEK has not been submerged for a while the display appears as shown below:

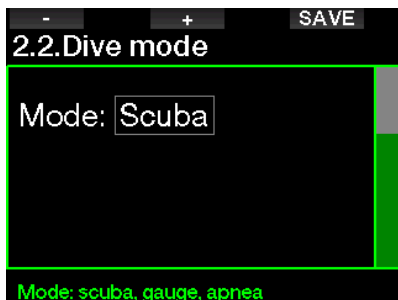

NOTE: Since Gauge and Apnea modes do not track tissue saturation, a 48-hour locking interval occurs between the time the last dive is made in Gauge or Apnea mode and a change to Scuba mode is possible. Conversely, the G2TEK shown below has been dived in Scuba mode and cannot be changed to Gauge or Apnea mode until the desaturation time has elapsed.

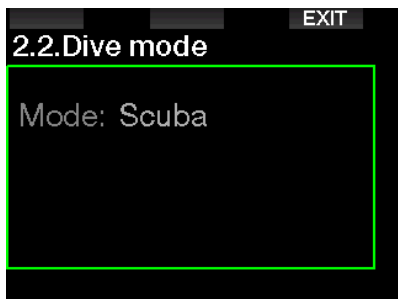

If you decide to change modes before the 48-hour interval ends, or before full desaturation occurs, you will have to go to the desaturation reset menu and make a manual desaturation reset. Refer to chapter **Desaturation reset** to learn how to manually reset the desaturation.

NOTE: Apnea mode is only available as a selectable dive mode if you have enabled it in the G2TEK's **8.7 Feature upgrade** menu. By default Apnea mode is disabled and the menu **2.2 Dive mode** will appear as **2.2 Gauge mode**.

2.2.3 Safety stop timer

Safety stop timer duration and start mode can be edited in this menu.

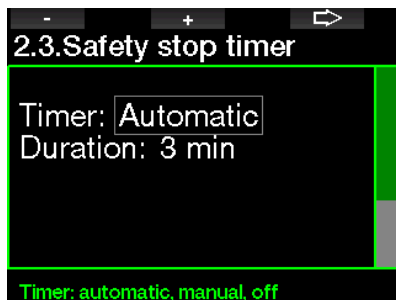

See chapter: **Safety stop timer** to learn how this feature is used while diving.

2.2.4 ppO₂ max

The ppO₂max setting defines the maximum limit for oxygen partial pressure. Gas O₂ settings higher than this limit cannot be selected for any tank.



2.2.5 Water type

The G2TEK measures pressure and converts it to a depth value by using water density as a constant. A depth of 10m/33ft in salt water corresponds approximately to 10.3m/34ft of depth in fresh water.

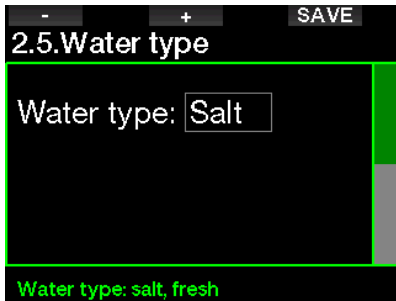

☞ **NOTE:** This setting will adjust the depth on all modes: Scuba, Gauge and Apnea.

2.2.6 Nitrox reset time

If you are generally diving with air and want to return to this setting after the occasional nitrox dive, you can preset a default time that will enable your G2TEK to reset back to air.

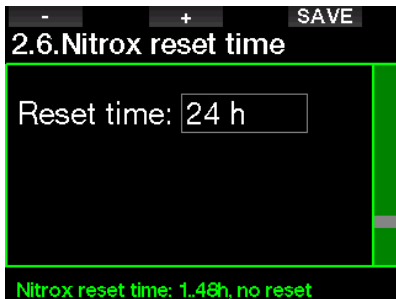

Reset time can be selected from 1 hour up to 48 hours, or the nitrox reset time can be disabled. Gas reset time is disabled when “no reset” is shown.

2.2.7 Max surface time

Maximum surface time allows you to enjoy short orientations at the surface while maintaining a single logged dive.

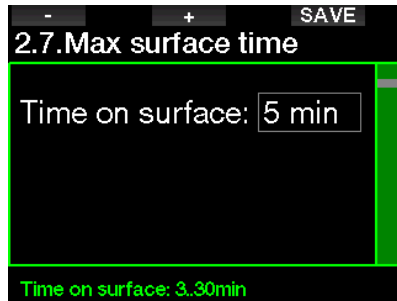

2.2.8 OTU settings

Oxygen Toxicity Unit (OTU) information and settings can be edited in this menu.

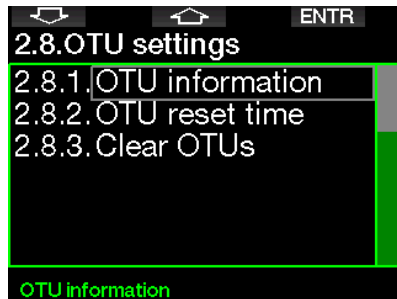

The OTU information screen below displays the current OTU related information:

1. OTUs from the last dive.
2. OTUs from the dives today along with the maximum allowed value.
3. OTUs allowed for tomorrow along with the maximum allowed value.
4. Total OTU dose during the mission (series of diving days).
5. Exposure (how many days of diving have occurred during this mission).
6. Interval (how many days have passed since the last dive day).

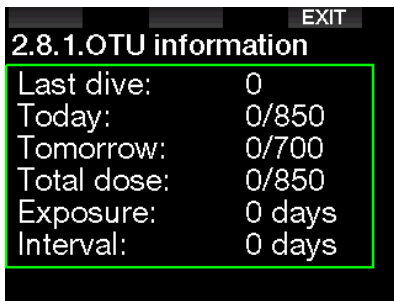

OTUs are calculated per day, changing at midnight (00:00) with limits changing accordingly.

You can define the reset interval, which is the length of time without logged dives required to clear the OTU counter.

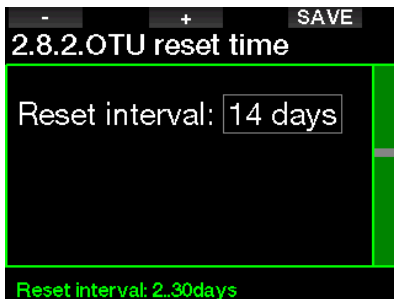

Also, if you wish to clear the OTUs manually you can do this with the following menu.

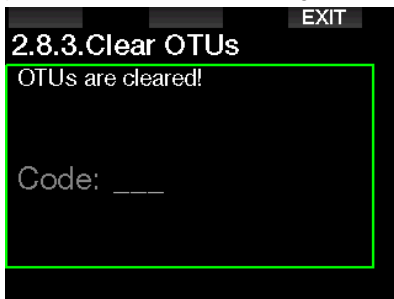

Clearing the OTUs requires the safety code 313.

2.2.9 Desaturation reset

The G2TEK allows you to reset the desaturation in the computer. Any tissue saturation information from a recent dives can be reset to zero, allowing the G2TEK to treat the next dive as a non-repetitive dive. This function is useful when the G2TEK is loaned to another diver who has not dived in the last 48 hours.

WARNING

Resetting desaturation will affect the calculations of the algorithm, which may lead to serious injury or death. Do not reset desaturation without a valid purpose.

 *NOTE: Some menu changes are not possible while the G2TEK is counting down desaturation. If you decide to reset desaturation, the safety code **313** must be used. This procedure prevents unwanted resetting, plus the desaturation reset will be stored to memory; in the next dive log the desaturation reset warning will be shown.*



When the safety code is correctly entered and confirmed by a press of the SAVE button, the desaturation reset is complete and the following screen will be shown.



NOTE: After a desaturation reset the change between Scuba, Gauge and Apnea modes are possible immediately. However, since the Gauge and Apnea modes are not tracking your tissue nitrogen loading, it is recommended that you maintain the initial intervals between mode changes.

⚠ WARNING

Diving after a desaturation reset is extremely dangerous and is very likely to cause serious injury or death. Do not reset the desaturation unless you have a valid reason to do so.

NOTE: An automatic low battery switch-off will not reset the desaturation. The G2TEK stores tissue saturation information in a non-volatile memory. During the time the computer is without power the desaturation calculation is frozen. During recharging, the display will light up and desaturation calculation will resume as soon as a sufficient level of charge has been reached.

2.2.10 All-silent mode

With the selection ON, the stealth mode becomes active and no alarms or warnings will be emitting an audible signal. (The factory setting is OFF)

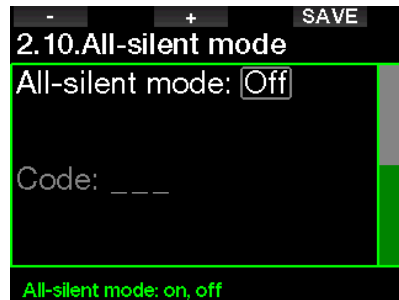

⚠ WARNING

The all-silent mode ON selection will disable all audible dive mode alarms and warnings. This could potentially be dangerous.

NOTE: The only exception to the stealth mode is the alarm clock, which will beep when activated, even if the all-silent mode is activated.

NOTE: In order to activate all-silent mode the safety code 313 must be entered. This is to prevent accidental deactivation of dive alarms and warnings.

2.2.11 Activating Sidemount

In sidemount diving there are normally two tanks and two regulators, each set mounted independently on each side of the diver.

Independent redundant gas delivery systems should be drawn down equally, in small steps, so in case one system fails the other system has maximum reserves to complete the dive.



When the G2TEK's Sidemount mode is activated (ON), two tank pressures are displayed at the same time. See chapter **Display configuration in Sidemount mode** to learn more about how the display is configured in this mode.

NOTE: For proper operation of the Sidemount mode, both tanks must be equipped with a transmitter.

The pressure step defines the pressure difference between tanks when the G2TEK alerts you to switch from the lower to the higher supply side. You can choose a step between 10 and 50 bars or follow the rule of thirds.

NOTE: The Sidemount mode can be used for backmount twin tank diving as well.

2.2.12 Activating CCR

The Rebreather mode can be set to ON here if the feature is enabled.

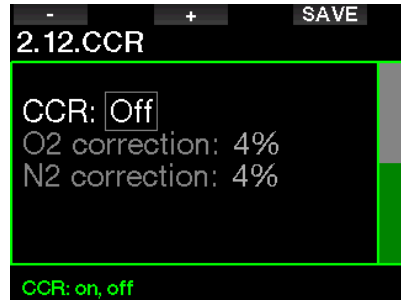

Enabling CCR changes the default open circuit gas content settings to setpoint settings. Also, the dive display will change so that both O₂ and Diluent tank pressures are shown at the same time. See chapter: **Display configuration in CCR mode** to learn more how the display is configured in this mode.

Since the CCR dive unit is responsible for the setpoint accuracy and the G2TEK is using that accurate number, you can select some conservatism with an O₂ and inert gas correction (it is shown as N₂ but also influences He when the TMx option is enabled).

For example, the % value of the O₂ correction increases the nominally set ppO₂ value for the CNS% clock value, and decreases the nominally set ppO₂ value for the inert gas absorption (algorithm).

2.2.13 Activating Trimix

Trimix can be set to ON here if the feature is enabled.

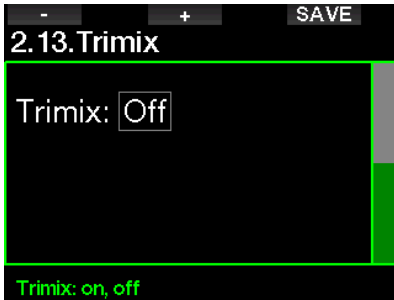

When Trimix is on, the gas content presentation follows the standard O₂/He. Also, the AMD (Absolute Minimum Depth) for each gas is shown. See chapter: **Diving with Trimix** to learn more about this feature.

2.2.14 Activating PMG

Predictive Multi-gas (PMG) mode enables the use of multiple tanks from 2 to 8.

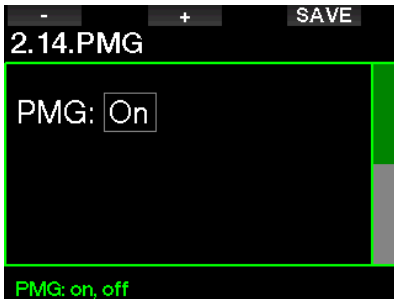

See chapter: **Diving with multiple gas mixtures** to learn more about how to use this feature.

NOTE: PMG must be enabled for Sidemount and CCR diving modes.

2.3 Apnea dive

If the Apnea feature is enabled in the G2TEK's **8.7. Feature upgrade** menu, the following settings for the Apnea mode can be edited.

1. Maximum depth
2. Depth increment
3. Dive time interval
4. Surface interval
5. Low heart rate
6. Ascent speed
7. Water density

2.3.1 Setting the maximum dual depth alarm

In Apnea mode all alarms can be either audible or disabled.

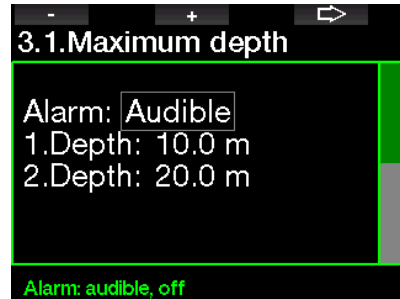

After enabling the maximum depth alarm the limits can be selected. The first depth alarm can be selected from 5-100m/20-330ft.

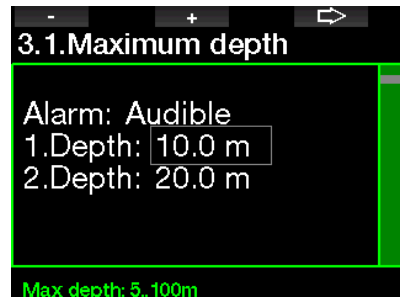

Equally, the second depth alarm may be set from 5-100m/20-330ft.



☞ **NOTE:** The first alarm is short sequence to get your attention, and the second alarm is continuous. By setting the first alarm deeper than the second, it will be masked by the continuous alarm and you cannot hear the first one.

2.3.2 Setting the depth incremental warning

Independent of the maximum depth alarm, you can set incremental depth warnings. These depth warnings can be set for descending (shown as Way down), for ascending (shown as Way up), or for both directions.

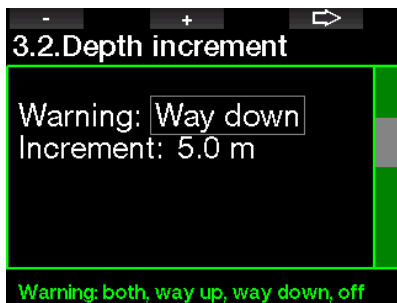

The depth increment can be selected from 5-100m/20-330ft.



2.3.3 Setting the dive time interval warning

You can set a dive time interval warning from 15 seconds up to 10 minutes.

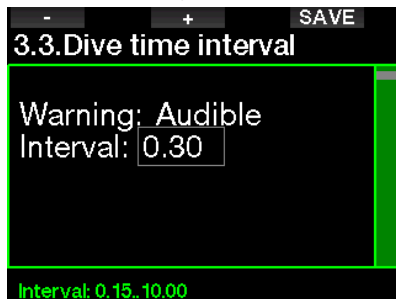

2.3.4 Setting the surface interval warning

The surface interval warning can be set from 15 seconds up to 14 minutes and 45 seconds.

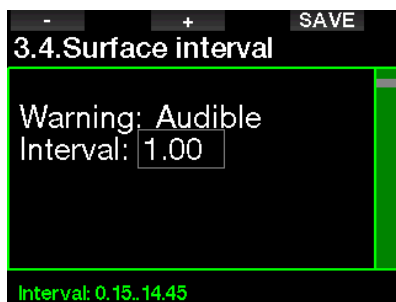

☞ **NOTE:** After 15 minutes on the surface, the G2TEK automatically ends the dive session and saves the dive in the logbook.

2.3.5 Low HR alarm

The G2TEK can trigger an alarm if your heart rate drops below a set level. The alarm can be set between 35 and 100 beats per minute.

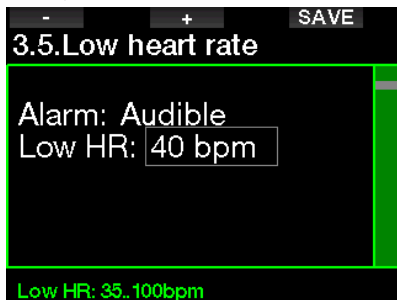

2.3.6 Setting the ascent speed alarm

The G2TEK can trigger an alarm if you exceed the preset ascent speed. You can select the value from 0.1-5.0m/1-15ft per second.

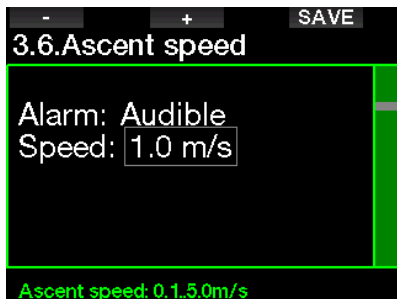

2.3.7 Water density

There is a direct relationship between the weight of a water column and the pressure it exerts, and the weight is given by the depth multiplied by the density of the water. Hence, the depth displayed by a dive computer is obtained by a measurement of absolute pressure.

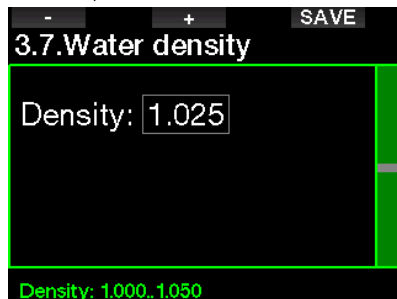

Water density, however, is a function of salinity, so the same depth in a lake (fresh water) and in an ocean (salt water) will yield a different pressure measurement.

The difference is very small, with a corresponding error in displayed depth (approximately 3%). For this reason, in Scuba and Gauge modes the G2TEK allows you to define whether you're diving in fresh or salt water.

A decompression calculation is based on absolute pressure, so setting the G2TEK to fresh water when diving in salt water, or vice versa, is acceptable. However, the depth measurement will be slightly off (approximately 1m/3ft every 40m/130ft), although the decompression calculation will be carried out correctly.

For Apnea diving, in which no decompression calculation takes place, the maximum depth reached by the diver may be the main goal of the dive, so accuracy in the depth measurement itself is the most important factor. The G2TEK allows you to define a water density between 1.000kg/l and 1.050kg/l in 0.001kg/l increments. (For reference, the density of the salt water setting in Scuba or Gauge mode is 1.025kg/l.)

2.4 Digital compass

In the menu **4.Digital compass** settings related to the digital compass can be selected.

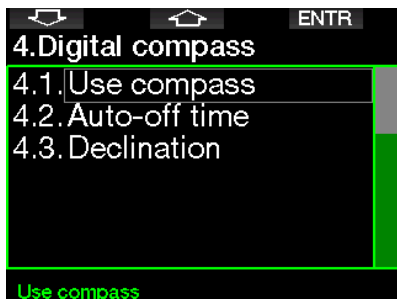

2.4.1 Accessing and using the digital compass

Entering the menu **4.1 Use compass** launches the digital compass on your G2TEK's screen, which looks like the following:



NOTE: You can also launch the compass from the G2TEK's main time-of-day display by pressing and holding the right button.

During diving the compass screen shows information about depth, dive time, tank pressure, no-stop time and RBT. The left button (BOOK) allows you to set bookmarks.



In case of GF stops or decompression, the lower right corner alternates every 4 seconds between decompression information and tank pressure together with RBT.



A press-and-hold of the right button from the compass display returns to the computer display. This also happens after the set auto-off time defined in chapter **Auto-off time**.

NOTE: If you are in compass mode when the G2TEK is about to end the no-stop phase, the screen will revert to the regular computer display regardless of the set auto-off time. Press and hold the right button again if you wish to return to the compass display.

You can set the compass bearing by pressing the middle (SET) button. Compass bearing represents the direction the front of the computer is pointed at. It is expressed in degrees, from 0 to 359. 0 degrees is North, 90 degrees is East, 180 degrees is South, 270 degrees is West and any other reading is interpolated in between.

The message **SET BEARING SUCCESSFUL** will be shown on the display and a white dot will appear in the position of the set bearing. Setting a bearing allows you to navigate towards a reference direction. A press-and-hold of the middle button will erase the set bearing. Note that the set bearing stays in memory until you either set a new one or erase it.



If you have set a reference bearing, arrows will appear to the left or to the right of the numeric bearing indication, to show you in which direction you should turn in order to match the set bearing. As an additional aid in navigation, the G2TEK automatically marks the positions at 90 and 120 degrees to the left and to the right of the set bearing, in addition to the position at 180 degrees (as an aid for square course, triangular course and reciprocal course navigation respectively). These are denoted with "T", Δ and II.



NOTE: Do not use the G2TEK's compass close to a magnet, as the magnetic force may cause the compass calibration to reset.

NOTE: When triggered, alarms and warnings will supersede the G2TEK's compass while it is active on the display. You will need to push-on for displaying the compass again.

2.4.2 Auto-off time

In the menu **4.2. Auto-off time** you can select a compass timeout, which is the amount of time the compass is displayed when activated at the surface or during a dive. Timeout can be set from 5 to 60 seconds, or the selection "Push on/Push off" maintains the compass display until it is switched off by a button press.

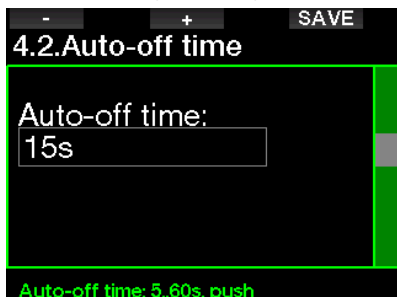

2.4.3 Declination

A compass points to the magnetic north pole of the earth. Geographic and magnetic North Pole difference is corrected with a declination setting. Declination depends on your current location on the earth. You can select a correction value from 0° to 90° in 1° increments and select the direction East or West.



NOTE: The G2TEK's compass does not normally need recalibration. If you note a significant permanent offset in compass direction, contact your authorized SCUBAPRO dealer.

2.5 Altimeter

Here you can check your current elevation. In the altitude menu, the current altitude is calculated from the barometric pressure. The altitude can be adjusted when current elevation is known. Adjusting the altitude elevation has no effect on the altitude class.



NOTE: Barometric pressure is variable, changing with weather and atmospheric pressure at any particular elevation. Dive algorithms use altitude classes which are directly derived from barometric pressure. Displayed altitude is determined based on the current barometric pressure and is therefore a relative value.

2.6 Warning settings

Warnings represent situations that require diver's attention, but ignoring them does not represent an immediate risk. It is up to you to decide which ones you would like to have active and which ones not.

2.6.1 Maximum dive depth warning

The maximum depth warning value can be selected from 5-100m/20-330ft in 1m/5ft increments.

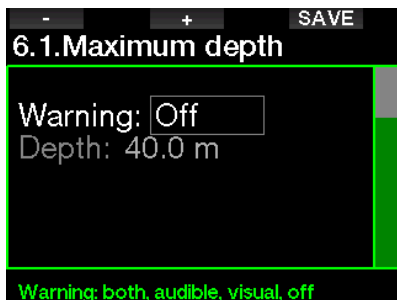

Warnings can be deactivated when OFF is selected. The visual warning selection displays the warning when the warning situation happens. The audible warning selection sounds the warning when the warning situation happens. By selecting BOTH you get a combination of audible and visual warnings.

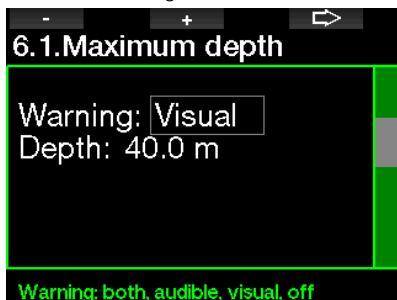

2.6.2 CNS O₂=75%

The G2TEK tracks your oxygen uptake via the CNS O₂ clock. If the calculated value of CNS O₂ reaches 75%, this warning becomes active.

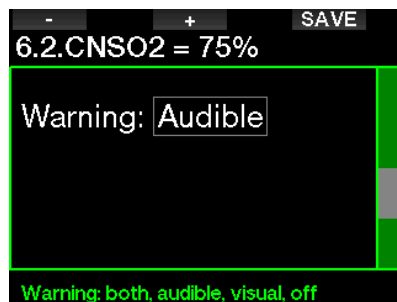

2.6.3 No-stop time = 2 min

If you wish to avoid unintentionally performing a decompression dive, the G2TEK can activate a warning when the no-stop time reaches 2 minutes. This applies to current selected GF no-stop time (see chapter: **Diving with GF settings**, for more information on diving with gradient factors). It gives you the opportunity to start ascending before incurring a decompression stop or a GF stop obligation.

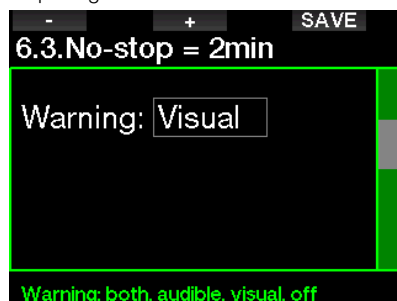

2.6.4 Entering deco

The G2TEK can activate a warning when the first mandatory decompression stop appears. This alerts you to the fact that a direct ascent to the surface is no longer possible.

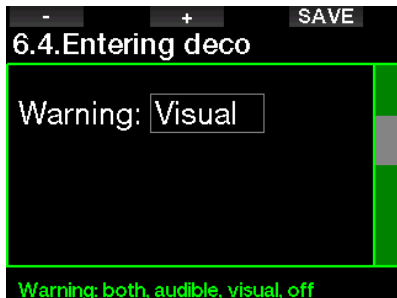

2.6.5 Maximum dive time warning

The value can be selected from 5 to 995 minutes in 1-minute increments.

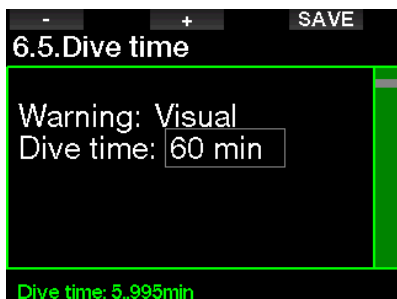

2.6.6 Tank pressure

The G2TEK can activate a warning when the tank pressure reaches the value defined here.



2.6.7 RBT = 3 min

The RBT (Remaining Bottom Time) is the time you can spend at the current depth and still have enough gas supply to make a safe ascent and reach the surface with the tank reserve. The RBT calculation is based on your current breathing rate, and it accounts for any existing and upcoming decompression obligation as well as for any temperature gradient in the water. It assumes an ascent at the ideal ascent rate (defined in chapter: **Ascent rate**). When the RBT reaches 3 minutes a warning is shown.

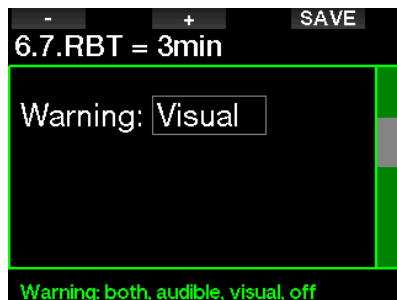

When 0 minutes RBT is reached, an alarm is triggered: the G2TEK has computed that if you start your ascent now and ascend at the ideal ascent rate, you will arrive at the surface with just the tank reserve, and any further delay increases the risk that you will run out of your gas supply before reaching the surface.

2.6.8 Pressure signal

The G2TEK can activate a warning when the wireless tank pressure signal has not been received in the last 30 seconds. The warning message is: **NO PRESSURE SIGNAL**.

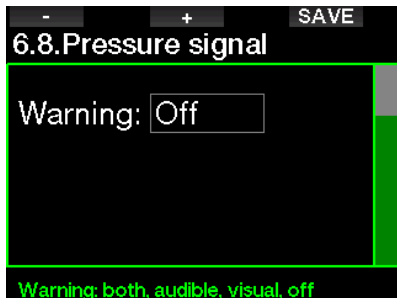

If after another 40 seconds the G2TEK still has not received any signal from the transmitter, another audible sequence are emitted with the message: **PRESSURE SIGNAL LOST**, after which the RBT is not displayed any longer and the tank pressure is replaced with - - -.

2.6.9 Entering GF stops

When diving with a GF setting different than 100/100, the G2TEK can warn you when you are no longer in the no-stop phase.

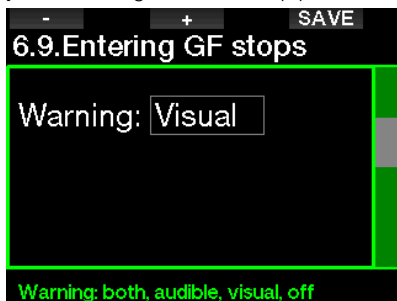

2.6.10 GF stop ignored

When diving with GF setting other than 100/100 and in the presence of GF stops, the G2TEK can warn you if you reach a depth shallower than the deepest required GF stop, therefore allowing you to avoid missing the required stop.



2.6.11 GF increased

When diving with GF setting other than 100/100 and in the presence of GF stops, if you ascend more than 1.5m/5ft above the deepest required GF stop, the G2TEK increases your GF settings low/high to the next possible level in steps of 10 for low and in steps of 5 for high. The display will show the new active GF setting. You can set your G2TEK to warn you when this happens.

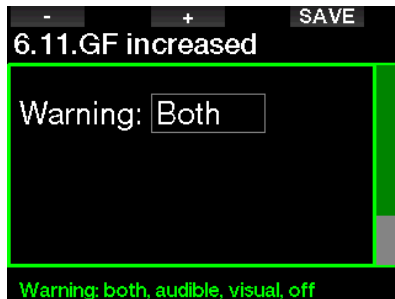

2.6.12 100/100 no stop time = 2 min

When diving with GF setting other than 100/100, the underlying 100/100 information is not directly visible on the display (though it is accessible as alternate information). You can choose to have your G2TEK warn you when the underlying 100/100 no-stop time reaches 2 minutes while diving with an active GF setting other than 100/100.

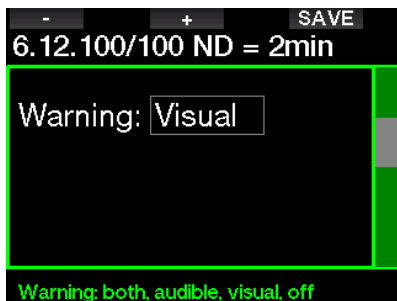

2.6.13 Enter 100/100 deco

When diving with GF setting other than 100/100, the underlying 100/100 information is not directly visible on the display (though it is accessible as alternate information). You can choose to have your G2TEK warn you when you are about to enter a decompression obligation while diving with an active GF setting other than 100/100.

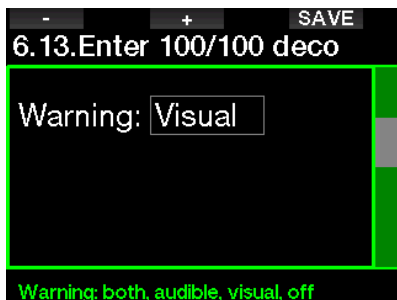

2.7 Clock settings

On this screen the current time, time format, date and time zone can be changed. The alarm clock may also be set and activated here.

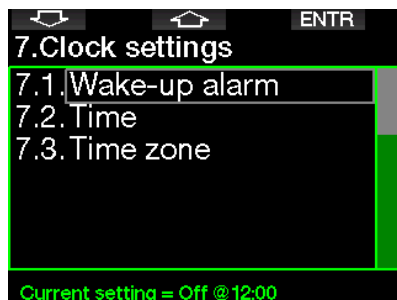

2.7.1 Wake-up alarm

This menu allows you to set a wake-up alarm. The time of the alarm is shown in the format specified in the Time menu (either in AM/PM or 24hr). When the alarm is set to ON, a bell symbol appears in the time-of-day display.

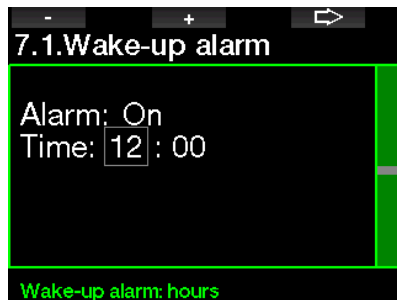

2.7.2 Time

This menu allows you to set the time format, time and date.

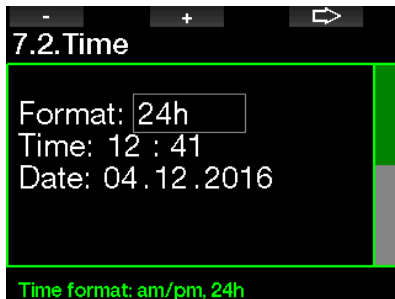

2.7.3 Time zone

This menu allows you to easily change the time when traveling to other time zones. Instead of changing the actual time itself, in this menu you can define a number of hours to add to or to subtract from the currently displayed time so as to get the correct time at your travel destination.



The range of the UTC setting is between -13 hours and +14 hours in 15-minute increments.

2.8 Other settings

Here you can see your G2TEK's ID and software version. You can also manually check the battery status, set the backlight, enable upgrades and return the unit to its basic factory settings.

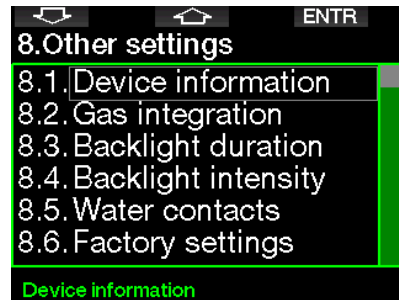

2.8.1 Device information

This menu displays the device ID number (ID), the hardware version (HW), the software version (SW) and the battery level.



2.8.2 Gas integration

In this menu you can edit various gas integration related settings.

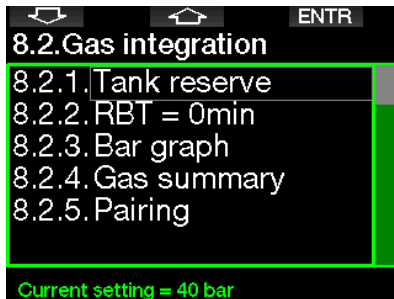

2.8.2.1 Tank reserve

The RBT (remaining bottom time) is the time you can spend at the current depth and still have enough gas supply to make a safe ascent and reach the surface with the tank reserve. The RBT calculation is based on your current breathing rate, accounts for any existing and upcoming decompression obligation and for any temperature gradient in the water. It assumes an ascent at the ideal ascent rate (defined in chapter: **Ascent rate**).

A higher value of the tank reserve is more conservative, but limits your diving time. A lower value gives you more diving time but the risk of running out of gas supply before reaching the surface increases.



2.8.2.2 RBT warning or alarm

In this menu you can select if the situation RBT = 0 minutes will be handled as a warning or alarm (visible only if PMG is installed).

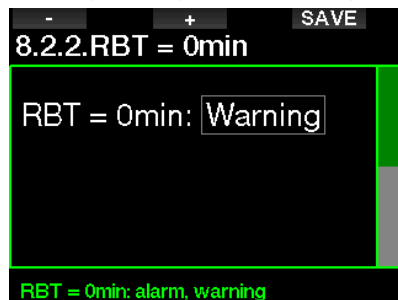

2.8.2.3 Bar graph

The oxygen bar graph can be replaced with a graphic representation of the tank pressure (on **Classic** and **Full** screens only). If you turn ON this feature, the label of the bar graph changes from O₂ to TK. To get proper scale, you must define a value of the pressure when the tank is full. As you consume the gas in the tank, the segments will gradually turn off.



2.8.2.4 Gas summary

The gas summary table provides a fast overview of the paired tank pressures and their content.

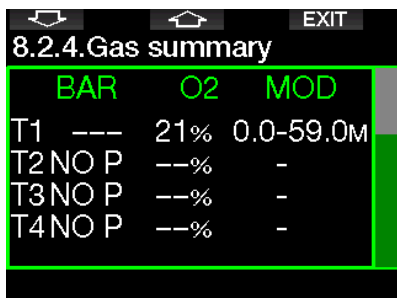

NOTE: A shortcut to this screen from the time-of-date display is a press-and-hold of the LOG button.

2.8.2.5 Pairing

When this menu is selected, the G2TEK listens to nearby tank transmitters which are activated (tank valve is opened). This mode is practical when you cannot place the G2TEK in close contact with the transmitter.

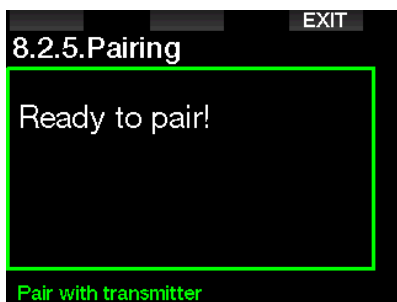

NOTE: Make sure that only one transmitter is active nearby when using this mode so that you will pair the right tank.

2.8.3 Backlight duration

Backlight power consumption is the main factor of the battery lifetime between charging. The time selected in this menu will define the active backlight duration before dimming function will take over. Selectable range is from 10 seconds up to 3 minutes or deactivate the automatic dimming function (push).

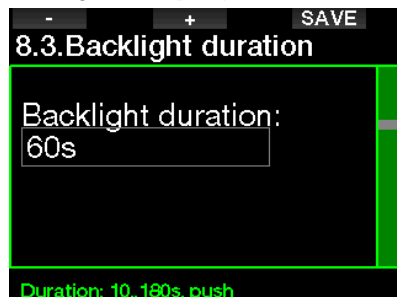

2.8.4 Backlight intensity

The ambient light sensor detects the level of darkness and the intelligent light algorithm can be set to provide different contrast levels if you select the adaptive backlight. When adaptive backlight is enabled the intensity range is from 1 to 9 and without adaptive function the range is from 1 to 15. Larger numbers correspond to more light, but also more power consumption and less battery lifetime.



2.8.5 Water contacts

The water contacts allow the G2TEK to automatically turn on the moment it senses the presence of water. This means that you can jump in the water at any time without having to worry whether the computer is turned on. However, if the computer is stored in a wet environment, it may stay turned on and consume unnecessary battery power. To prevent this, you can turn the water contacts off, but you will have to remember to turn on the computer manually before starting the dive.

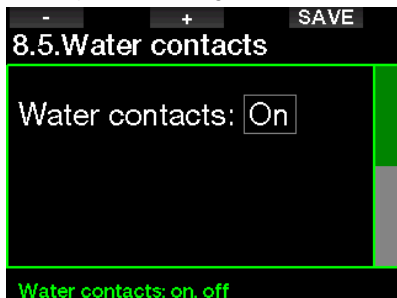

NOTE: If the water contacts are turned off and you fail to turn on the computer manually, the computer will still activate by itself within one minute of having started the dive. The time and decompression calculation will be consequently inaccurate, but the accuracy of the depth measurement will be unaffected.

The G2TEK will display the water drop symbol (💧) in the upper right section of the screen whenever its water contacts detect a wet environment while on the surface or after a dive.



2.8.6 Factory settings

This menu allows you to revert all settings in all menus of the computer back to the original factory settings (except emergency information, transmitter pairing, user information and Bluetooth pairing). In order to do this, you need to enter the safety code 313.

This prevents unintentionally reverting all settings.



2.8.7 Feature upgrade

Features that enhance your G2TEK's capabilities, but that are not initially enabled, are listed in this menu. If you need one of the features you can select and install it by pressing the SAVE button.



Features that you can install or deinstall are stored in the G2TEK's memory folder:

system\feature upgrade

See chapter: **USB flash disk operations** to learn how you can store these files in your G2TEK.

2.8.8 Software update

Software updates can be installed from the list in this menu.

To update the G2TEK's software proceed as follows:

1. Download the latest G2TEK software from scubapro.com to your PC/Mac.
2. Connect your G2TEK with the USB cable to your PC or Mac.
3. Once you see the message "Battery charging", press the left button (DISK)
4. Open your File Explorer/Finder and select G2TEK_DISK (PC) or click on the G2TEK Disk icon on your desktop (Mac). Go to the sub folder "System", select all folders from the downloaded update bundle (ZIP file) and drag and drop them into the "System" sub folder of the G2TEK_Disk.
5. Safely eject your G2TEK by clicking the Safe Removal icon.
6. Select the new software version in the G2TEK's **8.8. Software update** menu and install it by pressing the SAVE button.

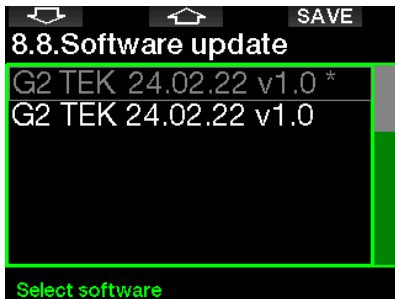

Software versions that you can install are stored in the G2TEK memory folder: \ system\SWUpdate

See chapter: **USB flash disk operations** to learn how you can store these files in your G2TEK.

2.8.9 Format flash disk

If G2TEK communication is interrupted during the flash memory write process, or if the G2TEK's battery power is exhausted when the flash is used, the memory content may become corrupted. In this case the G2TEK displays the following warning:



WARNING

Do not use the G2TEK if the flash disk becomes corrupted. The G2TEK may not operate correctly when flash memory access is not available. False operations may display faulty information. During a dive this may lead to serious injury or death.

NOTE: To prevent flash disk corruption, 1) use the Safe Removal and Eject Media function, and 2) keep the G2TEK battery charged to prevent unintended resets.

In case of corrupted flash disk, the following menu appears in menu **8. Other settings:**

8.9 Format flash disk

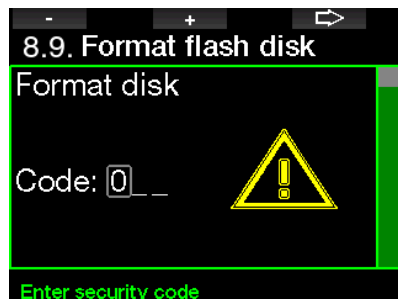

Security code 313 will be required to proceed with this operation.

⚠ WARNING

All data stored to flash will be erased. This includes all dive logs. To prevent the loss of your G2TEK data:

1. Keep a backup on your PC/Mac.
2. Download and store your dive logs with LogTRAK.

2.9 Pair Digital Heart Rate Monitor

In this menu the Digital HR monitor can be paired with your G2TEK. While you are in this menu the G2TEK is actively searching for a nearby heart rate monitor and will display the message: "Ready to pair!". Follow the instructions at chapter **Digital Heart Rate Monitor** on how to pair the HR monitor and establish connection to your G2TEK.

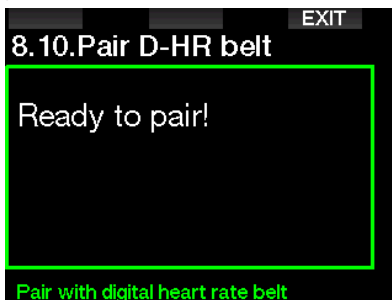

2.10 Personalization

Here are the settings related to customization. You can select different screen configurations, color, language, owner and emergency info and units.

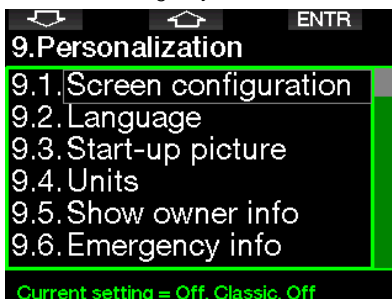

2.10.1 Screen configuration

You can choose between **Light**, **Classic**, **Full** and **Graphical** configurations. You can also rotate the display 180 degrees so that the buttons are at the bottom of the computer.

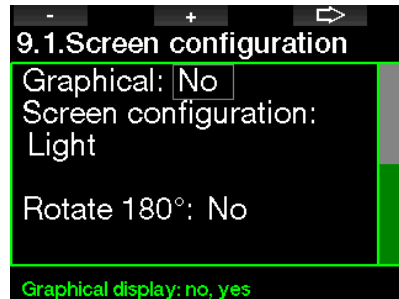

☞ *NOTE: The Light configuration does not support dives with GF stops or decompression stops. If you have chosen the Light configuration and you enter GF stops or decompression, the screen configuration will switch to Classic until you have fulfilled all GF stop and/or deco stop obligations.*

2.10.2 Language

In this menu you can set the language used for all texts displayed on the computer. Select the language from the list and press the SAVE button to activate.



2.10.3 Start-up picture

The G2TEK allows you to choose a personalized picture that will be displayed for 5 seconds upon turning on the computer. In this menu you can select the picture from those available in the computer's memory.



See chapter: **USB flash disk operations** to learn how you can store the pictures into your G2TEK.

NOTE: A press-and hold of the right button upon turning on the G2TEK will display the start-up picture.

2.10.4 Setting the user preferred units

Here you can select between depth, temperature and pressure unit combinations. The effect takes place in dive mode, in the logbook, alarm settings, altitude settings, etc.

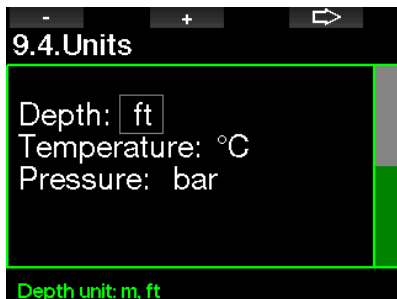

2.10.5 Show owner info

The owner information in this menu can only be entered via LogTRAK software.

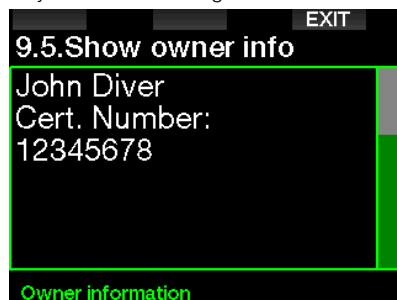

See section: **Introduction to LogTRAK** to learn how to store your owner information in your G2TEK.

2.10.6 Emergency info

The emergency information in this menu can only be entered via LogTRAK software.

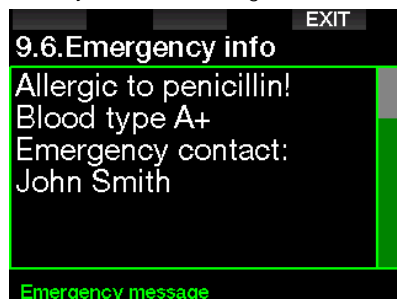

See section: **Introduction to LogTRAK** to learn how to store your emergency information in your G2TEK.

2.10.7 Display color

The G2TEK's display power consumption is independent of the color that's used. Using menu **9.7. Display color** you can select different color combinations, shown on the screen below.



NOTE: Depending on the water you're diving in, the best screen readability may be found using colors other than the default color combination or with black and white.

2.11 Pictures

Here you may look at the pictures that you have saved in your G2TEK's memory.



2.12 Dive planner

With the dive planner you can plan your next dive based on your body's nitrogen saturation. The planner also makes use of the following information:

1. Selected oxygen concentration.
2. Selected water type.
3. Selected GF settings.
4. Altitude range.
5. Status of saturation at the time the planner is activated.
6. Observation of the prescribed ascent rates.

NOTE: When the G2TEK is in Gauge or Apnea mode the dive planner is disabled.

2.12.1 No-stop plan

If you have completed a dive but plan to make another during the desaturation phase, you must start the planner by adding the time you would otherwise be on the surface. The time can be added in 15-minute increments.



The prohibited altitude is shown with the mountain symbol and the peak is not allowed to be entered by the diver. For more information on altitude diving with the G2TEK, see chapter: **Altitude diving**.

In case the G2TEK is displaying the no-dive warning, the duration of the warning itself is displayed as a recommended surface interval for planning purposes (rounded up to the nearest 15-minute increment).

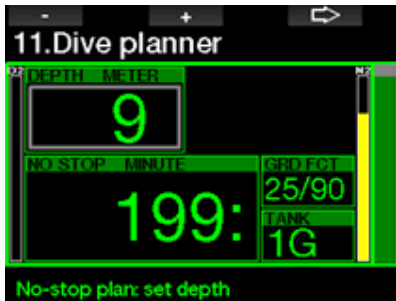

When the surface interval is given, or if you have no remaining desaturation left, the planner can show depth in 3m/10ft increments. The no-decompression dive time is shown for that depth.

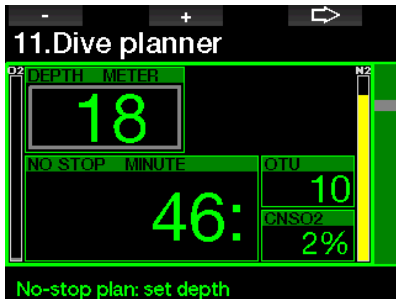

CNS% and OTU values appear on the screen when 1% would be reached for that depth with maximum no-stop time.

The minimum depth for dive planning is 9m/30ft. The planner allows only depths in line with maximum ppO_2 . The oxygen content and maximum ppO_2 settings are given in the menu **1. O₂ setting**.

⚠ WARNING

If you have set the $ppO_{2,max}$ to OFF, the planner will allow depths up to a maximum of 120m/394ft. Air/nitrox dives with a high ppO_2 are extremely dangerous and can lead to death. Be aware that exposures to high ppO_2 will lead the CNS clock value to exceed the maximum recommended 100%.

If the MOD is shallower than 9m/30ft, planning is not allowed and the G2TEK will show "ppO_{2,max} too low!"

2.12.2 Decompression plan



By pressing the ARROW button for planned depth the dive time can be edited. The start point (minimum now) is the no-decompression time. Time can be added in 1-minute increments. The deepest decompression or GF stop is also shown as well as the Total Ascent Time.

2.13 Bluetooth

Bluetooth communication can be activated from this menu. How to establish a connection between your G2TEK and other Bluetooth devices is described in chapter: **Bluetooth connection**.

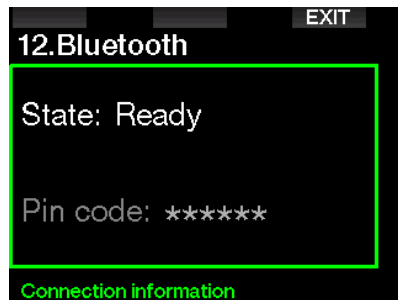

2.14 Logbook

Here the logbook can be read, including the overview that we call a dive statistic.

Dive statistics is always the starting point when the logbook mode is selected.

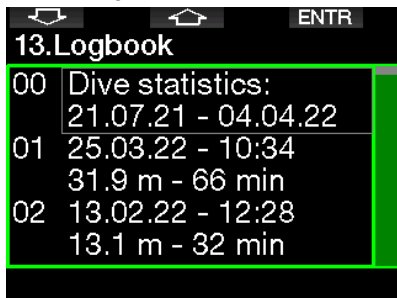

Dive statistic contains the following data.

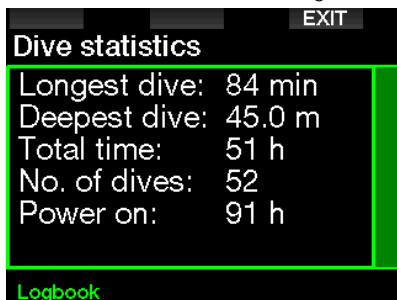

Each dive is stored with a running dive number along with immersion date, time, max depth and total dive time.

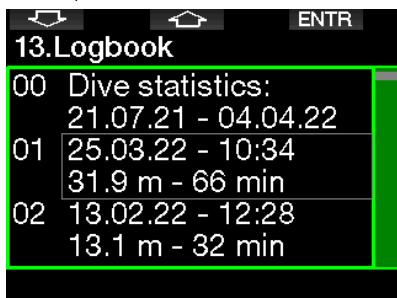

When a dive is selected the following data is shown on the 1st sub sequential page.

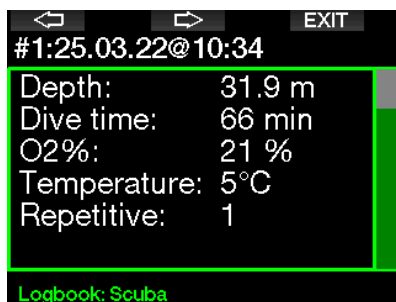

NOTE: If a dive is done in Gauge mode, it is indicated on this page. The Gauge mode contains less information than what's offered in Scuba mode; therefore, some lines will remain blank in the logbook. Below is an example of a Scuba mode dive.

The 2nd sub sequential page shows the dive log in graphics.



The 3rd sub sequential page shows more details.



The 4th sub sequential page.

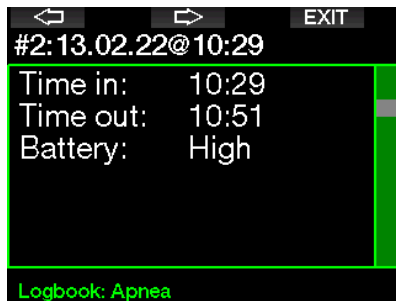
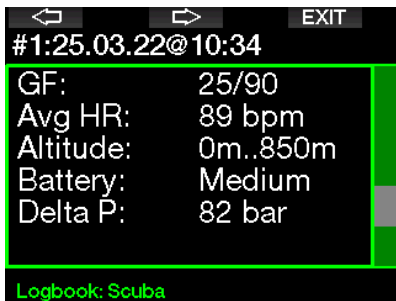

The 5th sub sequential page.

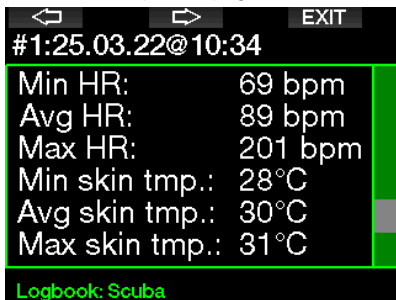

NOTE: Dives with multiple gases will add log pages after the 5th sub sequential page.

The 6th sub sequential page summarizes the warnings and/or alarms of the dive, if any.

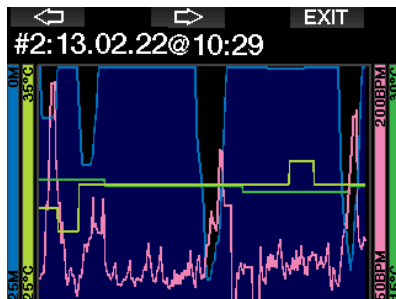
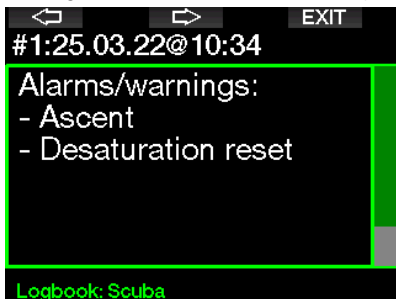

The following pages provide detailed information of a specific immersion of the session (the number is shown at the bottom of the display; for example, iteration #1, #2, etc.).

Apnea logs

The G2TEK organizes the Apnea dive log by grouping the individual immersions to a dive session. On the three first pages the session data is shown.

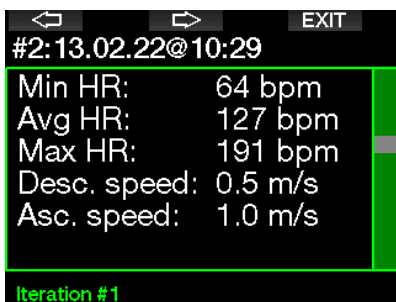

3. DIVING WITH THE G2TEK

The G2TEK is a feature-rich yet highly versatile diving computer, providing decompression calculations for easy recreational dives up to complicated mixed gas dives. It also provides ascent rate calculations and warnings. Its huge memory stores photos and provides a logbook capable of holding more than 1000 hours of dive profiles with a 4s sampling rate. During the dive the G2TEK displays information like depth, dive time, decompression status, water temperature and so much more, while on the surface after a dive, remaining desaturation time, no-fly time, surface interval and prohibited altitude classes are shown.

3.1 Dive mode at surface

3.1.1 Recreational (factory setting)

If you have not been diving with your G2TEK for a while (no desaturation remaining) the dive mode screen may appear as shown below:

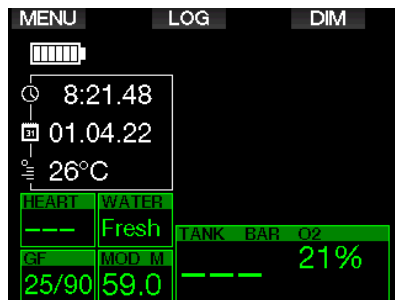

However, in Scuba mode following a dive, the display may appear as shown below.

The current altitude class and the prohibited altitude are indicated with the mountain symbol in the upper right hand corner. The interval since the last dive, as well as the remaining desaturation time, are counting up and down, respectively, in the middle of the screen.



Alternatively, when more advanced dive modes are activated the display may appear as follows (shown in PMG mode without a recent dive).

3.1.2 Display configuration in PMG mode

In Predictive Multi-gas (PMG) mode the amount of enabled gas mixes for the following dive is indicated in the gas pressure & content window below the mix. In the screen below two gas mixes are enabled (2G).

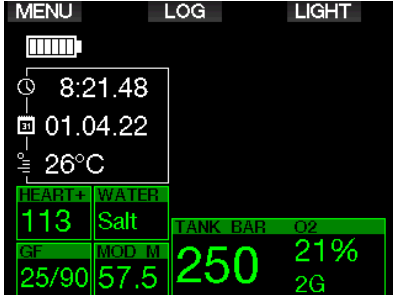

3.1.3 Display configuration in Trimix mode

In Trimix mode the gas content is shown in the tank pressure & content window in the Oxygen/Helium format.

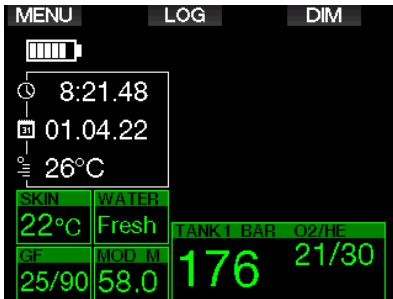

3.1.4 Display configuration in Sidemount mode

In Sidemount mode the tank pressure & content window is split into two tanks (left and right side).

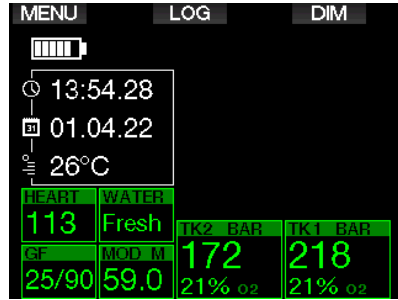

3.1.5 Display configuration in CCR mode

In CCR mode the display appears similar to Sidemount mode, but the tank pressure & content windows show the diluent and oxygen contents.

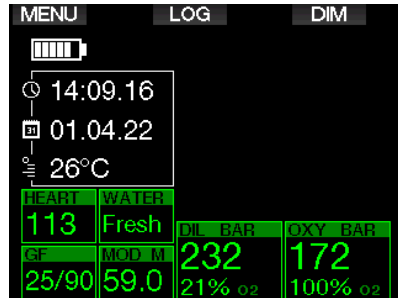

3.1.6 Surface interval, no dive and CNS% counters

After a dive the G2TEK shows the surface interval from the latest dive. The surface interval counter counts until desaturation is complete. After desaturation is complete this window disappears.

The no-dive symbol and countdown timer are shown to indicate the period during which you should not do another dive due to microbubbles or excessive oxygen loading (CNS O₂% > 40%).



3.2 Button functions while diving

The G2TEK's button functions while diving are summarized in the table below.

☞ **NOTE:** The G2TEK can be set to three dive modes: Scuba, Apnea and Gauge. Due to the operational differences between modes, the buttons will have different functions.

The cumulated oxygen CNS% from the last dive is counting down to zero next to the DESAT time, eventually disappearing.

	LEFT BUTTON		MIDDLE BUTTON		RIGHT BUTTON	
	Press	Press and hold	Press	Press and hold	Press	Press and hold
LIGHT	Set bookmark	-	Access alternate window in sequence:	Access alternate display in sequence:	Backlight	Compass
			Max depth	Dive profile		
				Compartment saturation		
			Temperature	Pictures		
			Heart rate			
			Skin temperature			
			Battery level			
			Active GF setting if not 100/100			
			GF 100/100 info			
			Time of day			
		CNS%				

CLASSIC	Set bookmark and reset stopwatch	-	Access alternate window in sequence:	Access alternate display in sequence:	Backlight	Compass
	(Confirm gas switch)	(Manual gas switch)	Max depth	Gas summary		
			O ₂ %	Deco summary		
				Dive profile		
			Heart rate	Compartment saturation		
			Skin temperature	Pictures		
			Battery level			
			Stopwatch			
			Active GF setting if not 100/100			
			GF 100/100 info			
			Time of day			
			CNS%			
FULL	Set bookmark and reset stopwatch	-	Access alternate window in sequence:	Access alternate display in sequence:	Backlight	Compass
	(Confirm gas switch)	(Manual gas switch)	O ₂ %	Dive profile		
				Compartment saturation		
			Average depth	Pictures		
			Skin temperature			
			Battery level			
			CNS%			
			PPO ₂			
		OTU				

GRAPHICAL	Set bookmark and reset stopwatch	-	Access alternate window in sequence:	Access alternate display in sequence:	Backlight	Compass
	(Confirm gas switch)	(Manual gas switch)	Max depth	Gas summary		
			O ₂ %	Deco summary		
				Dive profile		
			Heart rate	Compartment saturation		
			Skin temperature	Pictures		
			Battery level			
			Stopwatch			
			Active GF setting if not 100/100			
			GF 100/100 info			
			Time of day			
			CNS%			
			Average depth			
		ppO ₂				
		OTU				
COMPASS	Set bookmark and reset stopwatch	-	Set bearing	Erase set bearing	Backlight	Manually return to initial display
GAUGE	Set bookmark and reset stopwatch	-	Set bookmark and reset average depth	Access alternate display in sequence:	Backlight	Compass
				Gas summary		
				Dive profile		
			Pictures			
APNEA	Manually end the dive session (at the surface)	-	-	Access alternate window in sequence:	Backlight	-
				Heart rate		
				Skin temperature		

3.3 Altitude diving

3.3.1 Altitude classes and altitude warnings after a dive

Climbing to altitude is similar to starting an ascent from a dive: you expose your body to a lower partial pressure of nitrogen and you start off-gassing. After a dive, given the higher nitrogen loading in your body, even reaching an otherwise negligible altitude can potentially cause decompression sickness. Consequently, the G2TEK constantly monitors the ambient pressure and uses it to evaluate your nitrogen loading and off-gassing. If the G2TEK notices a drop in ambient pressure not compatible with your current nitrogen loading, it will activate a warning to alert you of a potentially dangerous situation.

The G2TEK counts down remaining desaturation and indicates this in the surface mode display until desaturation is complete.



The allowable altitudes are indicated with the mountain symbol in the right upper corner of the time-of-day display. The prohibited altitudes (which the G2TEK has computed to be incompatible with your current nitrogen saturation levels) are solid color segments inside the mountain symbol. For more details, see chapter: **Altitude and the decompression algorithm.**

The current altitude can be checked in the menu **5. Altimeter.**

The remaining nitrogen loading is shown with an indicator bar along the right edge of the display labeled with a description text N_2 .

NOTE: The no-fly, no-dive and altitude restriction symbols are also shown on the time-of-day display, when applicable.

3.3.2 Altitude and the decompression algorithm

Atmospheric pressure is a function of altitude and of weather conditions. This is an important aspect to consider for diving, because the atmospheric pressure surrounding you has an influence on the on-gassing and off-gassing of nitrogen. Above a certain altitude, the decompression algorithm has to change to account for the effect of the change in atmospheric pressure.

The G2TEK divides the possible altitude range into 5 classes that are illustrated below:

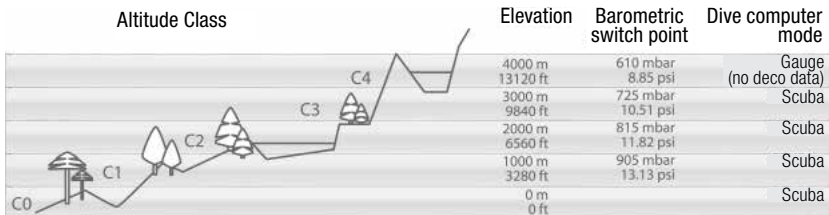

The altitude classes are defined in terms of approximate elevations because the effect of weather conditions can make the switch point pressure occur at different levels.

⚠ WARNING

At altitude class 4 the G2TEK functions in Gauge mode only (automatic switch from computer mode).

☞ NOTE: You can check your elevation by activating the altitude meter. Refer to chapter: **Altimeter to learn how to do so.**

☞ NOTE: The G2TEK deals with altitude automatically. It monitors the atmospheric pressure every 60 seconds and if it detects a sufficient drop in pressure, it indicates the new altitude range and, if applicable, the prohibited altitude range. It also indicates the desaturation time which, in this case, is an adaptation time to the new ambient pressure. If a dive is started during this adaptation time, the G2TEK considers it a repetitive dive since the body has residual nitrogen.

3.3.3 Prohibited altitude

Going to altitude, as well as flying after diving, exposes your body to a reduced ambient pressure. In a manner similar to no-fly time, the G2TEK advises you the safe altitude classes to reach after a dive, and those which are not safe. If you have to drive over a mountain pass to return home after a dive, this information can be quite important.



The prohibited altitude classes are displayed by yellow (factory initial setting color) segments inside the stylized mountain icon. These can be combined with gray (initial factory setting color) segments indicating the current altitude. In the example above, the diver is presently at altitude class 1 and should not reach altitudes of class 4 or higher.

The G2TEK has an altitude warning. If you reach an altitude that the G2TEK considers incompatible with your current residual nitrogen levels, it will warn you with an altitude warning.

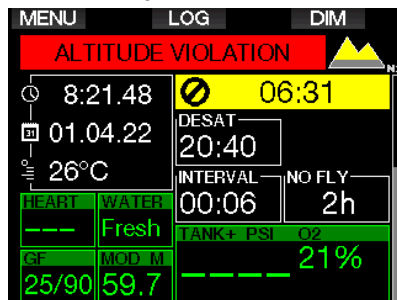

3.3.4 Decompression dives in mountain lakes

In order to ensure optimal decompression, even at higher altitudes, the decompression stop starts from 2m/7ft in altitude classes 1, 2 and 3.

If atmospheric pressure is below 610mbar (altitude higher than 4000m/13300ft), no decompression calculation is carried out by the G2TEK (automatic Gauge mode). In addition, the dive planner is not available in this altitude class.

3.4 Diving with nitrox

Nitrox is the term used to describe breathing gases made of oxygen-nitrogen mixes with the oxygen percentage higher than 21% (air). Because nitrox contains less nitrogen than air, there is less nitrogen loading on the diver's body at the same depth as compared to breathing air.

However, the increase in oxygen concentration in nitrox implies an increase in oxygen partial pressure in the breathing mix at the same depth. At higher than atmospheric partial pressures, oxygen can have toxic effects on the human body. These can be grouped into 2 categories:

1. Sudden effects due to oxygen partial pressure over 1.4bar. These are not related to the length of the exposure to high oxygen partial pressure. Sudden effects can vary and depend on the exact level of partial pressure they happen at. It is commonly accepted that partial pressures up to 1.4bar are tolerable during the active part of the dive, and maximum oxygen partial pressures up to 1.6bar during the decompression.

2. Long exposure effects to oxygen partial pressures over 0.5bar due to repeated and/or long dives. These can affect the central nervous system and cause damage to lungs or to other vital organs. Long exposures can be divided between more severe Central Nervous System effects and less dangerous long-term Pulmonary Toxicity effects.

The G2TEK treats high ppO_2 and long exposure effects in the following ways:

- **Against sudden effects.** The G2TEK has an MOD alarm set for a user-defined ppO_2 max. As you enter the oxygen concentration for the dive, the G2TEK shows you the corresponding MOD for the defined ppO_2 max. The default value of ppO_2 max from the factory is 1.4bar. This can be adjusted to your preference between 1.0 and 1.6bar. It can also be turned off. Please refer to chapter: **ppO_2 max** for more information on how to change this setting.

- **Against long exposure effects.** The G2TEK “tracks” the exposure by means of the CNS O_2 clock. At levels of 100% and higher there is risk of long exposure effects, and consequently the G2TEK will activate an alarm when this level of CNS O_2 is reached. The G2TEK can also warn you when the CNS O_2 level reaches 75% (see chapter: **CNS=75%**). Note that the CNS O_2 clock is independent of the value of ppO_2 max set by the user.

CNS O_2 75% warning and 100% alarm can activate during a dive (see chapters: **CNS O_2 = 75%** and **CNS O_2 = 100%**), whereas the remaining CNS O_2 value after a dive is shown in the time-of-day display.

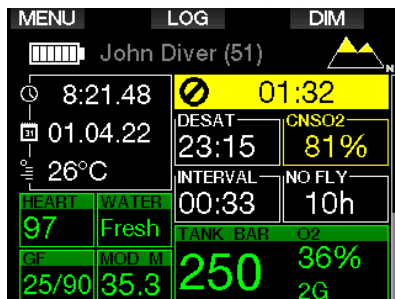

The CNS O_2 clock increases when the oxygen partial pressure is higher than 0.5bar, and decreases when the oxygen partial pressure is lower than 0.5bar. Hence, while on the surface breathing air you will always be decreasing the CNS O_2 clock. During the dive, the depth at which 0.5bar is reached for various mixes is as follows:

Air:	13m/43ft
32%:	6m/20ft
36%:	4m/13ft

☞ **NOTE:** For oxygen concentrations of 80% and higher, the ppO_2 max is fixed at 1.6bar and cannot be changed.

• **Against long exposure and repetitive dives.** Repetitive diving and very long exposures (technical and rebreather diving) with high ppO_2 may cause long-term pulmonary Toxicity effects that can be tracked with OTUs. See chapter: **OTU settings** how you can check your current OTU information or reset the counter. If you exceed your OTU's for the dive, this will be noted in the logbook alarms/warnings as shown on the screen below.

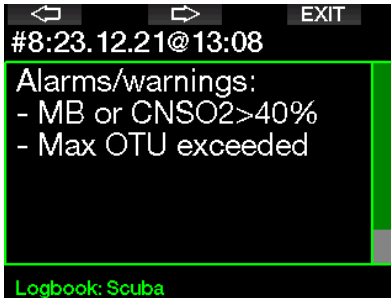

3.4.1 Technical diving

You should be trained and properly certified by a recognized agency in technical diving before using G2TEK for that. Decompression diving, diving with high oxygen percentage blends, multi gas diving and mixed gas diving all require skills and demand know-how that only specific training and education can provide. A dive computer is an electronic instrument that cannot make decisions for you and can not take all parameters into account while diving.

In technical diving a dive computer is not the primary instrument to follow during the dive. Before the dive you must make a plan and during the dive follow it. If your plan and the computer show different schedules, follow the more conservative one.

⚠ WARNING

Both G2TEK Trimix model and trimix diving are developed for healthy, physically fit, advanced divers. You should have regular medical check-ups with a specialized physician, confirming your physical aptitude for diving. This is even more important for technical diving.

Patience is a very important characteristic to maintain when conducting complex dives. It is necessary to build your personal depth limit and decompression amount based on your real diving experience and then increase little by little as you gain experience.

G2TEK is not designed for commercial diving. Special procedures such as surface supplied gas, heated suit, decompressing in a chamber or bell and long, high workload dives may cause algorithm to calculate incorrectly or even disturb the operation of the G2TEK dive computer.

Never dive without a backup instrument. It is imperative to always have backup instruments for depth, time and tank pressure, as well as a dive table with you while diving.

Plan your dives in advance and cross check your plan with another commercial planner program or table. Your dive plan should always include reserve gas amounts sufficient to handle emergencies and/or delays. Always make bailout tables for the dive.

Technical diving is not for everyone. Decompression diving, especially with Helium mixes, will always have a higher inherent potential for an accident, which could lead to permanent injury and death. The risk may be higher due to differences in an individual's physical condition, environmental conditions, human errors, etc. If you are not willing to take the risk, don't dive!

3.4.2 Diving with multiple gas mixtures

The G2TEK is equipped with the ZH-L16C GF PMG algorithm. PMG stands for Predictive Multi-gas, meaning that when you program more than one gas mixture, the G2TEK will predict the switch to the higher oxygen concentration gas at the depth that you specified and alert you at all times with a comprehensive decompression schedule of all the gas mixtures that you programmed.

In other words, you get full credit at any point during the dive for all the extra gas mixtures that you are carrying with you. At the same time, the G2TEK can also show you what the decompression schedule would be if you were to finish the dive using only the gas mixture that you are currently breathing from, so that you can be prepared in the event that something doesn't work as planned. See chapter: **Activating PMG** to learn how to activate this mode on your G2TEK.

⚠ WARNING

VERY IMPORTANT!

! Diving with multiple gas mixtures represents a much higher risk than diving with a single gas mixture, and mistakes by the diver may lead to serious injury or death.

! During dives with multiple gas mixtures, always make sure you are breathing from the tank that you intend to use. Breathing from a high oxygen concentration mix at the wrong depth can kill you.

! Mark all your regulators and tanks so that you cannot confuse them under any circumstances.

! Before each dive and after changing a tank, ensure that each gas mixture is set to the correct value for the corresponding tank.

! Get the proper training and certifications to make multi-gas dives prior to making them by yourself.

The G2TEK enables you to use up to 8 gas mixtures during the dive.

- For oxygen concentrations of 80% and higher, the ppO_2 max is fixed at 1.6bar and cannot be changed.
- The MOD for tanks 2 through 8 are the switch depths for those gases. This is what the G2TEK uses for its calculations, warnings and suggested switch points.
- When diving with more than 1 gas mixture, the nitrox reset time function (described in the chapter: **Nitrox reset time**) has the following effect: gas1 is set to 21% gases 2 through 8 are set to OFF.

☞ **NOTE:** Start breathing from the tank with the new gas mixture before confirming a switch.

⚠ WARNING

Always make sure you are switching to the intended gas. Failure to do so may result in serious injury or death.

The following chapters about gas switching are shown with 2 gas mixtures enabled. However, more than two mixes enabled are working similarly.

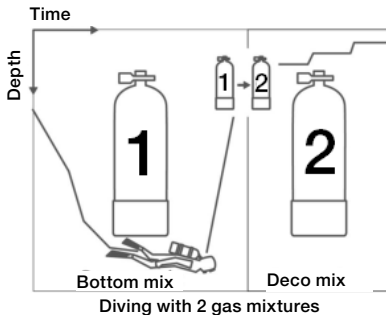

Switching gas mixture during the dive

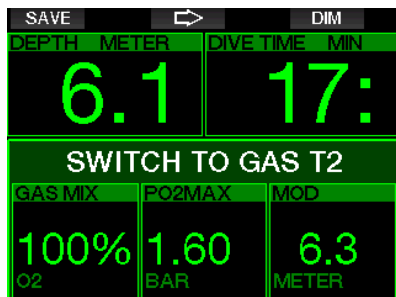

During the ascent phase, when you reach a depth corresponding to the MOD of a gas other than the one you are currently using, the G2TEK will suggest that you perform the switch. An audible sequence is played, and the message **SWITCH TO GAS T2** appears on the display. You have 30 seconds to respond to this message; otherwise, the G2TEK will conclude that gas 2 will not be used (text: **EXCLUDING GAS T2** will be displayed) and adapt the decompression schedule accordingly.

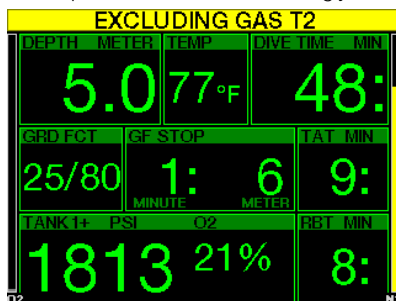

To confirm the gas switch, press the SAVE button. After you confirm the switch, the message **SWITCH TO GAS T2 SUCCESSFUL** remains on the screen for 4 seconds.



Switching back to a gas mixture with lower oxygen concentration

There may be situations in which you have to switch back to a tank with lower oxygen concentration. This can happen, for instance, if you want to descend again below the MOD of the higher oxygen concentration gas (T2), or if you have run out of T2 gas during the decompression. At this point you can manually initiate the gas switch by pressing and holding the BOOK button.

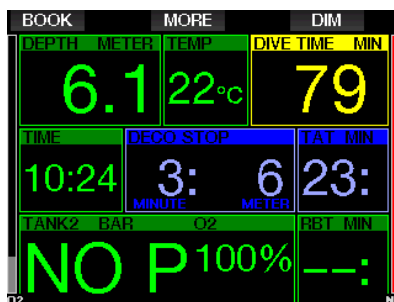

The G2TEK will display the message **SWITCH TO GAS T1**. At this point press the SAVE button to confirm the switch and the ARROW button to select another gas.

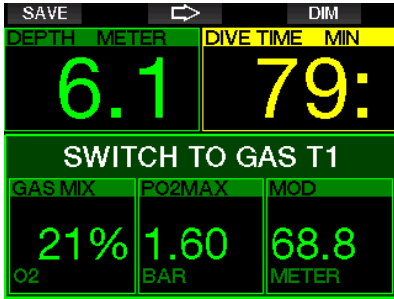

The G2TEK will display the text **SWITCH TO GAS T1 SUCCESSFUL** 4 seconds and adapt the decompression schedule accordingly.

Gas switch not carried out at the planned depth

If you fail to confirm the gas change within the 30 seconds of when the G2TEK suggests it, the gas is excluded from the decompression calculation and the decompression schedule is adapted accordingly, basically reflecting the fact that you will finish the dive without using the excluded gas.

Delayed gas switch

You can catch up on a planned gas mixture switch at any time by selecting the gas manually. Press-and-hold the BOOK button to start the gas switch procedure. The G2TEK will show the message **SWITCH TO GAS T2** on the display. This helps you verify that you are performing a switch to a safe gas. At this point you would press the SAVE button to confirm the switch. The G2TEK will display the message **SWITCH TO GAS T2 SUCCESSFUL** and adapt the decompression schedule accordingly.

Submerging below the MOD after a gas switch

If after having switched to gas 2 you inadvertently drop again below the MOD for that mixture, the MOD alarm will immediately be activated. In this case, you would either switch back to gas 1 or ascend above the MOD for gas 2.

Predicted decompression stops and gas changes during ascent

The main dive display will show only the deepest decompression stop depth and time with TAT.

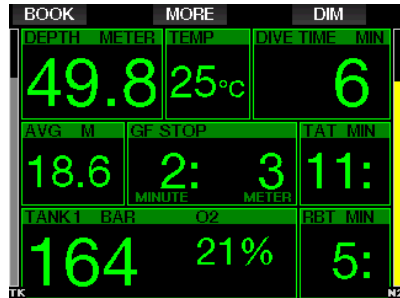

By a press-and-hold of the MORE button the gas summary table is shown. By pressing the MORE button, the predicted decompression stops are shown with all enabled gases used (PMG) and assuming only the current gas would be used (1G). Also, current selected GF stops as well as GF 100/100 schedules are shown.



By pressing the ARROW UP button the profile display is shown (blue is the dived part, the gray line identifies current time and green is the predicted ascent profile) with required gas switching depths according to MOD's (white lines).

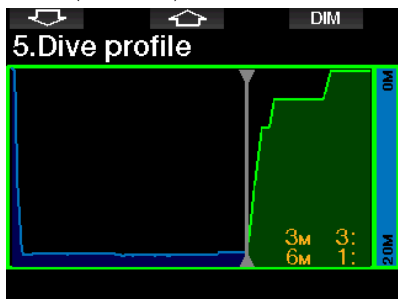

By pressing ARROW UP the current compartment saturation is shown.

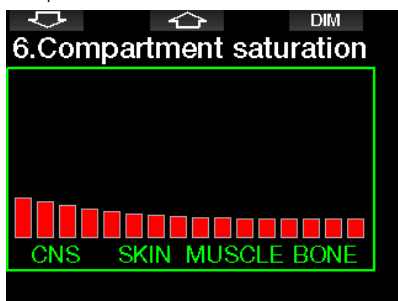

When the previously shown dive proceeds to the ascent phase the decompression is still increasing, as seen from the table information on the right side.

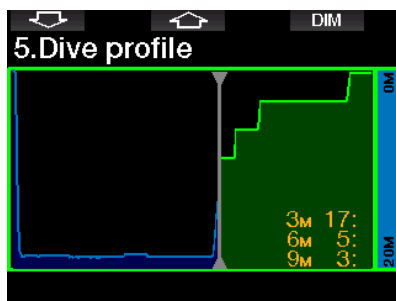

The fast compartments begin off gassing and the effect is shown in the saturation bar diagram below.

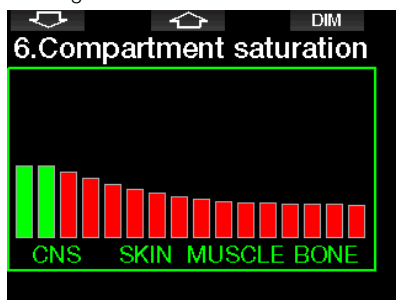

When off gassing the compartment color changes from red to green.

3.4.3 Diving with Trimix mode

WARNING

VERY IMPORTANT!

! When breathing compressed air or EAN Nitrox during a dive, the diver accepts a certain level of risk. When breathing a Trimix gas or other mix gases during a dive, the risk level increases.

! We have used all relevant data and the most recent hyperbaric research on Trimix diving to bring the risk level of our Trimix algorithm to the lowest possible acceptable level. Nevertheless, we can in no way guarantee that breathing Nitrox, Trimix, mixed gases or compressed air during a dive using our Trimix algorithm will eliminate or prevent the risk of serious injury or death from decompression sickness, oxygen toxicity or some other inherent risk.

! The Trimix diver using our Trimix algorithm on our dive computers should be aware of the risk level and be willing to accept that personal risk and bear the full legal responsibility of such risks. If the diver is not willing to accept those risks, including serious injury or death, then he or she should not dive with our Trimix mode.

! Never risk your life on only one source of information. Eventually, every computer has the potential to fail, so do not depend exclusively upon it and always have a plan for how to handle failures. Use a redundant dive computer, carry backup tables and depth/time instrumentation. If you make riskier dives, obtain the proper training from a recognized agency to gain the required technical skills and experience needed for this type of diving. Computer technology is never a substitute for knowledge and training

WARNING

Before performing trimix dives with the G2TEK you should practice no-stop recreational diving to become accustomed to the interface and functions of the dive computer.

Minimum and Maximum Operating Depth

Absolute Minimum Depth (AMD) and Maximum Operating Depth (MOD) are calculated from the oxygen content in the mix. The ppO_2 that is given by the user is divided by the oxygen fraction. The result will be pressure, which is converted to depth. The maximum MOD is valid for all gases, while the minimum AMD is only applicable to a gas mix where the oxygen fraction is less than air.

 NOTE: Air (21/0) gives a different MOD than, for example, trimix 21/10. The reason is, the G2TEK uses a more precise value for the oxygen in the air, which is 20.7%.

WARNING

Altitude diving with hypoxic mixes requires proper acclimatization. Adaptation to lower ppO_2 levels is a slow process requiring your body to produce more red blood cells. The adaptation time is personal and cannot be directly calculated. Desaturation due to pressure drop when arriving at altitude is another factor (see chapters: **Altimeter and Altitude diving**).

Gas selection

In technical diving, especially with Trimix blends, the decompression efficiency becomes extremely important. Gas mixes with high helium content and low oxygen content are not well suited for decompression.

For example, where two decompression mixes are in most cases enough when air or nitrox is used as a bottom gas, in the case of trimix the optimal off gassing requires more decompression mixes.

So, the PMG option shall be enabled together with trimix as described in chapter:

Diving with multiple gas mixtures also applies to trimix diving.

Tank 1 is always the starting gas from the surface. When you have set more than one tank, you may change gas during the dive manually, or when the G2TEK suggests it.

The minimum O₂ setting for tank T1 is 18%. This is due to the limitation that a dive must begin with gas 1. To ensure an adequate supply of oxygen to the body, the gas used at the beginning of the dive must contain enough oxygen (you can use a travel mix or one of the decompression gases) as is required for Tank 1. Therefore, the first alarm related to Absolute Minimum Depth would be given at shallower than 1.2m/3.9ft.

⚠ WARNING

Heavy work while at the surface or at shallow depths while breathing with less than 21% oxygen fraction may cause a loss of consciousness and lead to drowning.

The minimum O₂ setting for other tanks than tank 1 is 8%.

⚠ WARNING

Low Oxygen fraction settings may allow greater MOD values. The dive computer cannot evaluate your skills, experience or condition to dive the MOD which is showing. Dive only at depths that your certification allows.

The G2TEK calculates the maximum possible helium fraction by subtracting the oxygen fraction from 100%.

⚠ WARNING

Helium reduces the narcotic effect of the mix, but does not remove it. At great depths, helium may also cause an effect called "Helium tremors" or HPNS (High Pressure Nervous Syndrome).

The gas summary table is practical when handling multiple gas mixtures. It can be called up on a pre-dive check as well as any time during the dive.

	BAR	O2/HE	MOD
T1	245	18/40	0.0-80.7M
T2	205	12/60	5.3-109M
T3	215	50/15	0.0-18.6M
T4	245	100%	0.0- 6.3M

👉 *NOTE: The Smart transmitter communicates the pressure signal frequently only from the actively used tank. When the tank is not used within 5 minutes, the transmitter goes to a power save mode and the pressure update to a gas summary table may take longer.*

Compartment saturation with Trimix

In Trimix mode the compartment saturation shows combined both helium and nitrogen saturations separated by a thin line. On-gassing and off-gassing of the compartments are indicated the same way as with a color change.

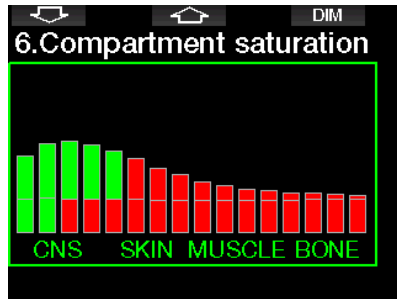

3.4.4 Diving with Sidemount mode

Prior to diving with Sidemount mode, you have to make sure that the features “Sidemount” and “PMG” in the G2TEK’s **8.7 Feature upgrade** menu are enabled. Afterwards the Sidemount mode has to be activated, as described in chapter **Activating Sidemount**. Activating the Sidemount mode will automatically activate the PMG mode as well. Pair two sidemount tanks with equal oxygen mixture to your G2TEK and you are ready to go.

NOTE: For technical diving you can pair 6 additional tanks and the G2TEK will guide you through your dive.

The G2TEK starts the sidemount dive with tank T1. The RBT value is shown considering you are using both tanks. When the preset threshold step is reached, the G2TEK will suggest that you perform the switch to the other tank. An audible sequence is played and the message SWITCH TO GAS T2 appears on the display. You have 30 seconds to respond to this message.

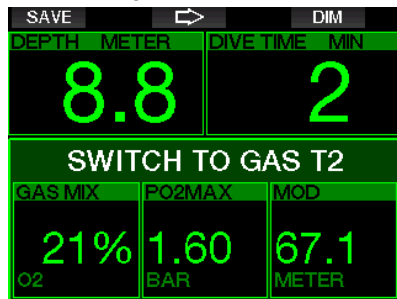

If you for any reason do not switch to the requested tank, the G2TEK will mark the currently used tank with an underlying red triangle. The triangle points to the other tank. This indicates you should switch to that tank, because the threshold step is reached.

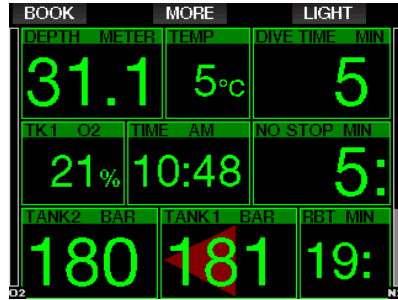

Delayed gas switch: You can catch up on a recommended tank switch at any time by selecting the tank manually. Press-and-hold the BOOK button to start the tank switch procedure. The G2TEK will show the message SWITCH TO GAS T2 on the display. This helps you verify that you are performing a switch to the recommended tank. At this point you would press the SAVE button to confirm the switch. The G2TEK will display the message SWITCH TO GAS T2 SUCCESSFUL.

3.4.5 Diving with CCR mode

The CCR (Closed Circuit Rebreather) system is probably older than the Open Circuit Scuba system because the basic operating principle with manual control didn’t require a highly reliable regulator system.

The CCR system also uses the gas more efficiently than an open loop system, because the oxygen is added to the breathing loop only as needed. Respectively, the carbon dioxide generated by the body is bound to calc at the scrubber. As a side effect the CCR system is nearly bubble-free, which can be beneficial when engaged in photography or observing fish under water.

In the CCR system the breathing gas ppO₂ (partial pressure of the oxygen) is kept constant. The CCR system itself takes care of this. Compared to an open loop system the constant ppO₂ converts to a variable nitrox mix at different depths.

For example, a ppO₂ setting of 1.0bar is comparable to an open loop 50% nitrox mix at a depth of 10m/33ft in salt water.

⚠ WARNING

All rebreathers require unit specific education before using them. Get the proper certifications and follow manufacturer recommendations and procedures when diving with a rebreather unit. Deviations may lead to severe injury or death. Rebreathers use multiple gases, bailout procedures which are equal to gas switching and many technical diving techniques. Therefore, all considerations and warnings of the previous chapters apply to rebreather diving.

When the CCR mode is activated, the diluent tank appears in O₂ setting.

See chapter: **Activating CCR** to learn how to activate this mode.

The dive start setpoint (SP1) has a selectable range from 0.2 up to 0.95bar ppO₂. The bottom setpoint (SP2) has a range from 1.0 up to 1.6bar ppO₂ and this

is switched normally active on the way to the bottom or when the bottom depth is reached.

The SP switch depth is suggested by the dive computer the same way the gas switches are suggested in open circuit mode (predictive gas switching).

The switch points are determined by the equivalent oxygen contents in open circuit mode. So, when the switch point is reached on the way down when the equivalent content of the gas at that depth reaches the diluent O₂ level.

For example, with a SP1 of 0.5bar of the air diluent the depth would be approximately 13.8m/45.3ft in salt water.

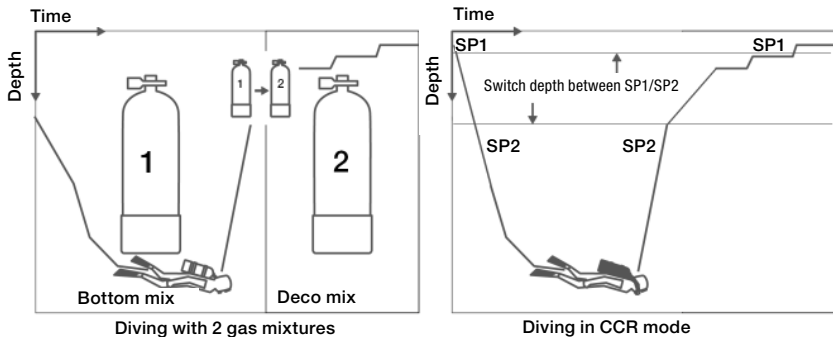

3.5 Warnings and alarms

The G2TEK can alert you to potentially dangerous situations via warnings and alarms. You can modify the warning and alarm settings in the menus or via a PC interface.

3.5.1 Warning settings

Warnings represent situations that require diver's attention; however, ignoring them does not necessarily represent an immediate risk. It is up to you to decide which ones you would like to be active.

Warnings are shown in the pop-up window at the top of the display where button descriptions are normally viewed. The warning color is YELLOW and the related data window is highlighted at the same time.

Generally, warnings can be set to AUDIBLE, VISUAL, BOTH (audible and visual) or OFF.

The available warnings are:

3.5.2 Maximum depth

MAX DEPTH REACHED			
DEPTH	METER	TEMP	DIVE TIME MIN
18.3		26°C	3
MAX	M	TIME	NO STOP MIN
18.0		14:14	20:
TANK	BAR	O2	RBT MIN
161		21%	74:

Maximum depth will trigger a warning. See chapter: **Maximum dive depth warning** to learn how to set the warning depth.

3.5.3 CNS O₂ = 75%

The G2TEK tracks your oxygen uptake via the CNS O₂ clock. If the calculated value of CNS O₂ reaches 75%, the G2TEK will warn you until the value drops below 75%.

CNS O2 = 75%			
DEPTH	METER	TEMP	DIVE TIME MIN
23.9		77°F	51
CNSO2	GF STOP	TAT	MIN
75%	2: 3	5:	
	MINUTE	METER	
TANK+	PSI	O2	RBT MIN
2959		36%	10:

3.5.4 No-Stop time = 2 min

NO STOP = 2 MINUTES			
DEPTH	METER	TEMP	DIVE TIME MIN
17.4		26°C	20:
HR+	BT/MN	TIME	NO STOP MIN
97		18:10	2:
TANK	BAR	O2	RBT MIN
95		21%	93:

If you wish to avoid unintentionally performing a decompression dive, the G2TEK can activate a warning when the no-stop time reaches 2 minutes. (See chapter: **Diving with GF settings**) for more information on diving with GF settings). It gives you the opportunity to start ascending before incurring a decompression stop or a level stop obligation.

3.5.5 Entering decompression

The G2TEK can activate a warning when the first mandatory decompression stop appears. This alerts the diver to the fact that a direct ascent to the surface is no longer possible.

3.5.6 Dive time

See chapter: **Maximum dive time warning** to learn how to set this warning time.

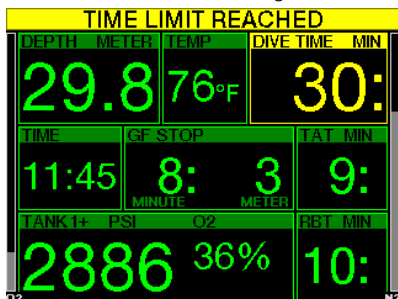

When the set dive time is reached (see example above: 30 minutes) the warning message is: **TIME LIMIT REACHED**.

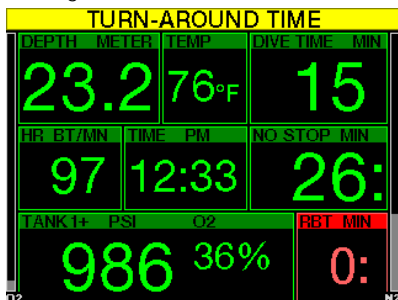

Half of the dive time warning (above set 30 minutes = 15 minutes) gives the warning message: **TURN-AROUND TIME**.

3.5.7 Tank pressure

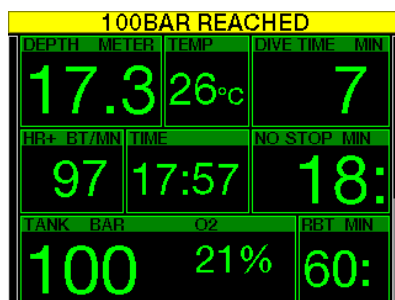

The G2TEK can warn you when the tank pressure reaches a certain level. For instance, you can set it to half the full tank pressure as a reminder that it is time to start a slow ascent.

3.5.8 RBT = 3 min

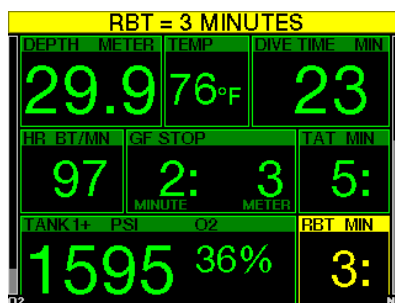

In order to give you sufficient warning that your gas supply may be running low, the G2TEK can warn you when the RBT (remaining bottom time) drops to 3 minutes. See chapter: **RBT = 3 min** for more information on RBT.

⚠ WARNING

If the RBT drops to 3 minutes or less, you may not have enough gas supply to complete a safe ascent. Start ascending when you see this warning.

3.5.9 Pressure signal

NO PRESSURE SIGNAL					
DEPTH	METER	TEMP	DIVE TIME MIN		
17.0		26°C	25:		
HR+	BT/MN	GF STOP		TAT MIN	
97		2:	3	5:	
		MINUTE	METER		
TANK	BAR	O2	RBT MIN		
91		21%	10:		

Wireless tank pressure information, under certain circumstances—such as inappropriate positioning of the transmitter or interference from strong RF sources, can be momentarily interrupted. Strokes used in underwater photography, for example, are known to momentarily affect the communication between the G2TEK and the wireless transmitter.

☞ **NOTE:** If the G2TEK receives no signal from the transmitter for 30 seconds, an audible sequence goes off and the message **NO PRESSURE SIGNAL** appears on the display for 12 seconds. If, after another 40 seconds, the G2TEK still has not received any signal from the transmitter, another audible sequence sounds and the message **PRESSURE SIGNAL LOST** appears for 12 seconds, after which the RBT is not displayed any longer and the tank pressure is replaced with ---.

⚠ WARNING

In the event of a **NO PRESSURE SIGNAL** situation, all tank pressure-related information on the G2TEK ceases to be valid. In such a case, you must use a backup instrument for pressure monitoring and seek a safe ascent to the surface. Running out of gas under water is dangerous and may lead to severe injury or death by drowning.

3.5.10 Entering GF stops

ENTERING GF STOPS					
DEPTH	METER	TEMP	DIVE TIME MIN		
17.9		26°C	23		
HR+	BT/MN	GF STOP		TAT MIN	
97		1:	3	4:	
		MINUTE	METER		
TANK	BAR	O2	RBT MIN		
93		21%	78:		

When diving with a setting other than 100/100, the G2TEK can warn you when you are no longer in the GF no-stop phase. For more information, see chapter: **Diving with GF settings.**

3.5.11 GF stop ignored

When diving with GF setting other than 100/100 and in the presence of GF stops, the G2TEK can warn you if you reach a depth shallower than the deepest required GF stop, therefore allowing you to avoid missing the required stop.

GF STOP IGNORED					
DEPTH	METER	TEMP	DIVE TIME MIN		
4.9		30°C	50		
GRD FCT	GF STOP		TAT MIN		
25/85	4:	6	23:		
	MINUTE	METER			
TANK1+	PSI	O2	RBT MIN		
1015		21%	8:		

3.5.12 GF increased

When diving with GF other than 100/100 and in the presence of GF stops, if you ascend more than 1.5m/5ft above the deepest required GF stop, the G2TEK increases your GF to the next possible value. The display will show the new active GF setting.

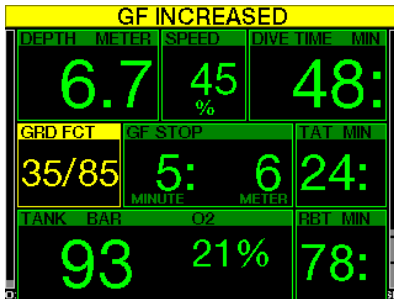

3.5.13 GF no-stop = 2 min

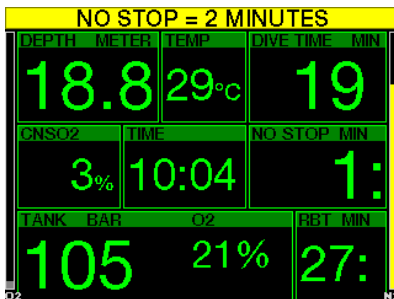

When diving with GF setting other than 100/100, the underlying 100/100 information is not directly visible on the display (though it is accessible as alternate information). You can choose to have your G2TEK warn you when the underlying 100/100 no-stop time reaches 2 minutes while diving with an active GF setting other than 100/100.

3.5.14 Entering decompression at 100/100

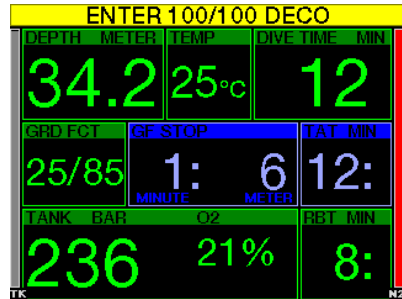

When diving with GF setting other than 100/100, the underlying 100/100 information is not directly visible on the display (though it is accessible as alternate information). You can choose to have your G2TEK warn you when you are about to enter a decompression obligation while diving with an active setting other than 100/100.

3.6 Alarms

The diver cannot turn off alarms because they represent situations that require immediate action.

Alarms are shown in the pop-up window at the top of the display where button descriptions are normally viewed. The alarm color is RED and the related data window is highlighted at the same time.

There are 7 different alarms:

- ASCENT TOO FAST
- MOD EXCEEDED
- CNS O₂ = 100%
- TANK RESERVE REACHED
- MISSED DECO STOP
- RBT = 0 min
- LOW BATTERY

⚠ WARNING

- When in Gauge mode, all warnings and all alarms are OFF except for the low battery, tank reserve, half tank, max depth, max dive time and pressure signal alarm
- When the G2TEK is set to SOUND OFF mode, all audible alarms and warnings are switched off.

3.6.1 Ascent rate

As you ascend during a dive, the pressure surrounding you decreases. If you ascend too quickly, the ensuing pressure reduction could lead to microbubble formation. If you ascend too slowly, the continued exposure to high ambient pressure means that you will continue loading some or all of your tissues with nitrogen. Consequently, there is an ideal ascent rate that is slow enough to minimize microbubble formation yet fast enough to minimize the effect of continued loading on your tissues.

The pressure reduction that the body can tolerate without significant microbubble formation is higher at depth than it is in the shallows: The key factor is not the pressure drop by itself, but rather the ratio of the pressure drop relative to the ambient pressure. This means that the ideal ascent rate at depth is higher than it is in the shallows.

Along these lines, the G2TEK employs a variable ideal ascent rate. Its value ranges from 3 to 10m/min (10 to 33ft/min) and the actual breakdown by depth range is listed in the table below.

DEPTH		ASC SPEED	
m	ft	m/min	ft/min
0	0	3	10
2.5	8	5.5	18
6	20	7	23
12	40	7.7	25
18	60	8.2	27
23	75	8.6	28
31	101	8.9	29
35	115	9.1	30
39	128	9.4	31
44	144	9.6	32
50	164	9.8	32
120	394	10	33

If the ascent rate is greater than 110% of the ideal value, the speed window turns yellow.

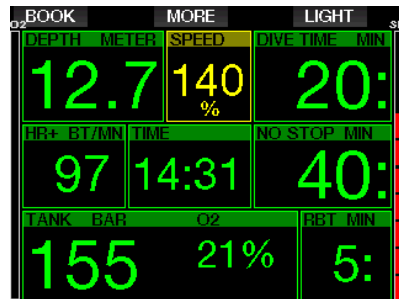

For ascent rates higher than 140%, the **ASCENT TOO FAST** warning is displayed and the ascent window changes to red.

ASCENT TOO FAST!			
DEPTH	METER	SPEED	DIVE TIME
		%	MIN
4.5		199	21:
HR+	BT/MN	SAFETY	NO STOP
			MIN
97		2.58	199:
TANK	BAR	O2	RBT
			MIN
155		21%	10:

The G2TEK also provides an audible alarm for ascent rates exceeding 110%: the intensity of the alarm increases in direct proportion to the degree that the ideal ascent rate is exceeded.

In the event of a too-fast ascent, the G2TEK may require a decompression stop even within the no-stop phase because of the danger of microbubble formation.

From great depths a slow ascent may cause increased saturation of tissues and an extension of both decompression duration and total ascent time. At shallow depths, a slow ascent may shorten the decompression duration.

Excessive ascent rates for longer periods are entered in the logbook.

⚠ WARNING

The ideal ascent rate must not be exceeded at any time, since this could lead to microbubbles in the arterial circulation which could cause serious injury or death.

The alarm persists for as long as the ascent rate is 110% or more of the ideal ascent rate.

3.6.2 MOD/ppO₂

⚠ WARNING

- The MOD should not be exceeded. Disregarding the alarm can lead to oxygen poisoning.
- Exceeding a ppO₂ of 1.6bar can lead to sudden convulsions resulting in serious injury or death.

MOD EXCEEDED			
DEPTH	METER	TEMP	DIVE TIME
			MIN
30.3		26°C	0
MOD	M	TIME	NO STOP
			MIN
29.0		15:26	14:
TANK	BAR	O2	RBT
			MIN
116		36%	--:

If you exceed the MOD, the depth change to red with alarm text: **MOD EXCEEDED**.

The MOD is displayed in an alternate display window so you can see by how much you have exceeded it. In addition, the G2TEK will beep incessantly. Both the blinking of the depth value and the beeping will continue for as long as you stay deeper than the MOD.

3.6.3 CNS O₂ = 100%

⚠ WARNING

When the CNS O₂ reaches 100% there is danger of oxygen toxicity. Start the procedure to terminate the dive.

The G2TEK tracks your oxygen uptake via the CNS O₂ clock. If the calculated value of CNS O₂ reaches 100%, the G2TEK will emit a sequence of audible beeps for 12 seconds and the value of the CNS O₂ will turn red in the O₂ window. The red color will continue until the value of CNS O₂ drops below 100%.

CNS O ₂ = 100%!			
DEPTH	METER	SPEED	DIVE TIME MIN
6.8		45 %	5
CNSO ₂	TIME	NO STOP MIN	
102%	17:45	199:	
TANK BAR	O ₂	RBT MIN	
103	100%	99:	

The audible signal is repeated for 5 seconds in 1-minute intervals after the first occurrence, and for as long as the value of CNS O₂ stays at or above 100% or until the ppO₂ drops under 0.5bar (see chapter: **Diving with nitrox** for a list of depths at which the ppO₂ equals 0.5bar for typical nitrox mixes).

3.6.4 Tank reserve pressure reached

See chapter: **Tank reserve** to learn how to set the tank reserve pressure limit. When this set pressure is reached during the dive an alarm is triggered.

TANK RESERVE REACHED			
DEPTH	METER	TEMP	DIVE TIME MIN
16.7		25°C	17
HR+ BT/MN	TIME	NO STOP MIN	
97	14:28	11:	
TANK BAR	O ₂	RBT MIN	
26	21%	--:	

3.6.5 Missed decompression stop



WARNING

Violating a mandatory decompression obligation may result in serious injury or death.

MISSED DECO STOP!			
DEPTH	METER	SPEED	DIVE TIME MIN
5.3		45 %	17
GRD FCT	DECO STOP	TAT MIN	
100/100	1: 6	14:	
	MINUTE	METER	
TANK BAR	O ₂	RBT MIN	
105	21%	27:	

If, when conducting a required decompression stop, you ascend more than 0.5m/2ft above the required stop, the G2TEK will trigger an alarm. The value of the current depth and the text: **MISSED DECO STOP!** is shown and a sequence of beeps can be heard. This will continue for as long as you stay 0.5m/2ft or more above the required stop

3.6.6 RBT = 0 min

The situation when RBT reaches 0 minutes can be selected as a warning or alarm. See chapter: **RBT warning or alarm** to read more about this setting.

RBT = 0 MINUTES			
DEPTH	METER	TEMP	DIVE TIME MIN
29.8		76°F	25:
HR BT/MN	GF STOP	TAT MIN	
97	1: 3	4:	
	MINUTE	METER	
TANK+ PSI	O ₂	RBT MIN	
1175	36%	0:	

3.6.7 Low battery

⚠ WARNING

Do not start a dive if the low battery warning is displayed on the screen at the surface. The computer may fail to function during the dive and this could lead to serious injury or death.

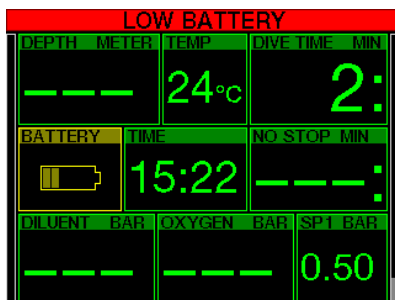

During the dive, the G2TEK alerts you of precarious battery situations in two ways:

1. By displaying a battery symbol with a background warning color on the screen.
2. By displaying a warning message at the top of the display (where button descriptions are normally shown).

3.7 Display information

Upon immersion, the G2TEK will automatically start to monitor the dive regardless of what state it was in prior to the immersion. Details on the information displayed can be found in the next sections.

Dive time. The dive time is displayed in minutes. If during the dive you ascend to the surface, the time spent on the surface will only be counted if you descend again below 0.8m/3ft within 5 minutes (default setting, or you can set from 3 to 30 minutes). This allows for brief periods of orientation. While on the surface, the time will not show as progressing but it is running in the background. As soon as you submerge, the time will resume, including the time spent on the surface. If you spend more than 5 minutes (or which time you have set) at depth shallower than 0.8m/3ft, the dive will be considered ended, the logbook closed and a subsequent immersion would cause the dive time to start again from zero. Maximum displayed time is 999 minutes. For dives longer than that, the dive time starts again from 0 minutes.

Only dives longer than 2 minutes are stored to logbook.

Depth. The depth is given in 10cm resolution in metric mode. When displayed in feet, the resolution is always 1 foot. At a depth shallower than 0.8m/3ft, the display shows ---. The G2TEK's maximum possible operating depth is 120m/394ft.

No-stop time. Calculated in real time and updated every 4 seconds. Maximum displayed no-stop times is 99 minutes.

Temperature. The G2TEK displays the water temperature during the dive and the air temperature while on the surface. However, skin temperature influences the measurement when the unit is worn against the skin.

Decompression information. When the G2TEK calculates the need for a mandatory decompression stop, it shows you how long and how deep your deepest stop is. It also gives you the total ascent time.

⚠ WARNING

During all dives, perform a safety stop between 3 and 5 meters (10 and 15 feet) for 3 to 5 minutes, even if no decompression stop is required.

3.7.1 Display configuration during the dive

The G2TEK lets you select from four screen layout options: **Light**, **Classic**, **Full** or **Graphical**. You can also rotate the screen, if you prefer, to have the buttons positioned at the bottom of the screen.

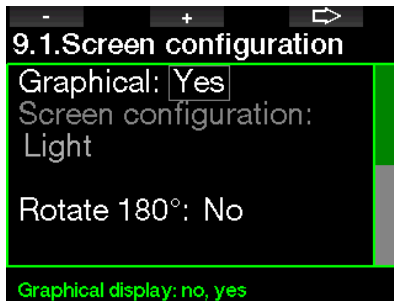

The **Light** screen configuration is the factory default. It shows only the basic information with large numbers. When the dive requires decompression and more information must be shown on the display, the display changes automatically to the **Classic** configuration.

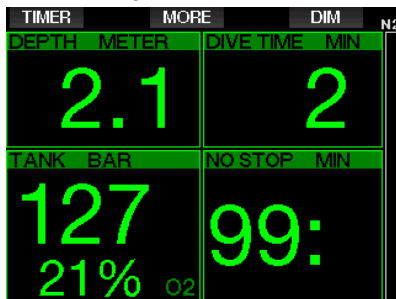

☞ **NOTE:** only the shorter between no-stop time and RBT is shown in **LIGHT** configuration. If your remaining gas supply is such that you will enter GF or deco stops prior to reaching an RBT of 0 minutes, the no-stop time will be displayed on the screen, emphasized by the **NO STOP** label. If on the other hand your remaining gas supply is such that you will reach RBT of 0 minutes while still in the no-stop phase, then the RBT will be displayed on the screen, emphasized by the **RBT** label

More specifically, the following information is displayed:

- current depth
- dive time
- tank pressure
- the shorter between no-stop time and RBT
- O₂ mix
- nitrogen loading (via bar graph)

⚠ WARNING

After a **PRESSURE SIGNAL LOST** warning the G2TEK is no longer able to compute the RBT. In such case, the **LIGHT** configuration shows the no-stop time but this does not imply that you have enough gas supply to remain at that depth for that amount of time.

The **Classic** screen presents more information with smaller numbers in smaller windows.

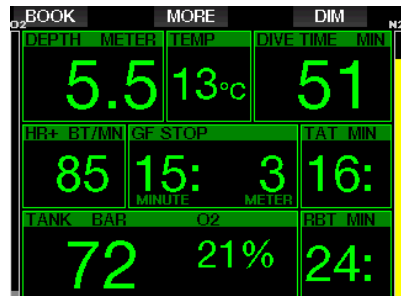

The **Full** screen configuration displays the maximum amount of information. This screen is for divers who prefer to monitor

all of the parameters that the G2TEK can provide.

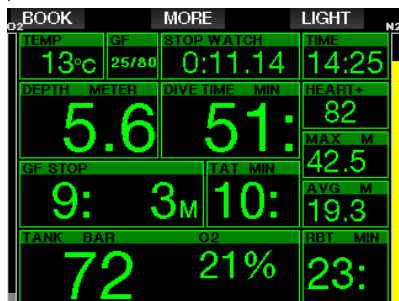

surfacing are shown on the right side of the cursor line.

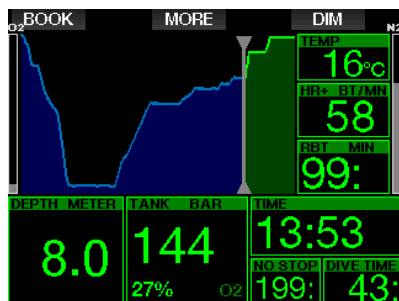

The **Graphical** screen configuration combines numeric information with an actual dive profile. The diver is represented by the gray cursor line in the graphical profile. Projected ascents and stops before

Regardless of screen configuration, the G2TEK utilizes one window for displaying additional information regarding the dive. By pressing the MORE button the G2TEK will show in sequence the following data on the different screens:

Screen configuration	Light	Classic	Full	Graphical
1	Tank pressure	Max depth	O ₂ %	Max depth
2	Max depth	O ₂ %		O ₂ %
3			Average depth	
4	Temperature	HR	Skin temperature	HR
5	HR	Skin temperature	Battery level	Skin temperature
6	Skin temperature	Battery level	CNS%	Battery level
7	Battery level	Stopwatch	ppO ₂	Stopwatch
8	Active GF setting if not 100/100	Active GF setting if not 100/100	OTU	Active GF setting if not 100/100
9	GF 100/100 info	GF 100/100 info		GF 100/100 info
10	Time of day	Time of day		Time of day
11	CNS%	CNS%		CNS%
12		Average depth		Average depth
13		ppO ₂		ppO ₂
14		OTU		OTU

A press-and-hold of the MORE button launches a dive profile (or gas/deco summary displays depending on GF/PMG settings) display. This screen will remain for 12 seconds and return to the normal dive display unless buttons are pressed.

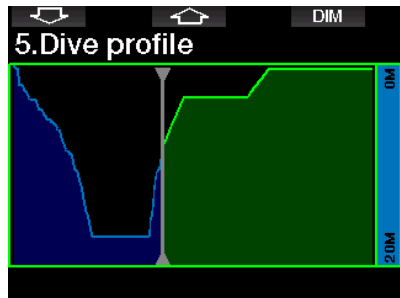

With the ARROW buttons you can scroll to the next display, which is the relative compartment saturation display. The height of each bar indicates the ratio of current tissue loading with respect to the maximum tolerable loading, expressed in a percentage. The green color indicates that the compartment is off-gassing, and the red color shows on-gassing.

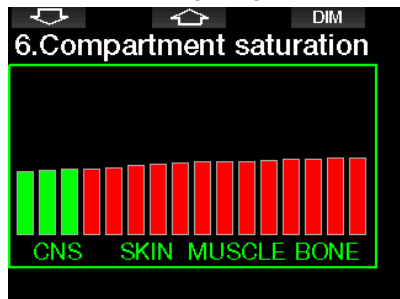

The following display shows a list of pictures stored in the G2TEK's flash memory. See chapter: **USB flash disk operations** for more information on how and where to save pictures that can be viewed during the dive.

With a press-and-hold of the middle button you will enter the pictures list. With the ARROW buttons you can select the picture you want to view. A press-and-hold of the middle button lets you view the selected picture.

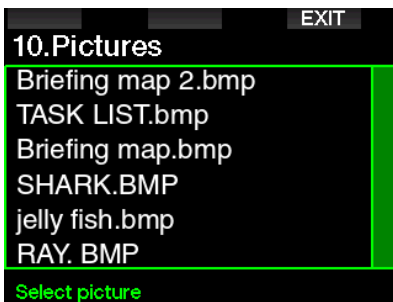

You can use the pictures for:

- fish identification
- dive site maps
- task/check lists
- notes

and many other underwater purposes. Following are some examples:



NOTE: Profile, compartment saturation, and pictures can be viewed for a maximum of 1 minute, after which the normal dive screen will appear again. If any warning or alarm is triggered while viewing alternate screens, the G2TEK will immediately revert to the normal dive screen.

 **NOTE:** Your G2TEK comes with five preloaded sample dive screens (examples of classic, full, graphical and light display configurations) on its flash drive. You will find these sample screens in the folder "Pictures" when connecting your G2TEK in DISK mode to your PC or Mac.

3.7.2 Setting bookmarks

By pressing the BOOK button you can set any number of bookmarks as reminders of particular moments during the dive. The bookmarks will appear on the dive profile in LogTRAK.

3.7.3 Stop watch timer

There are many situations during a dive where a simple stop timer is practical (timed tasks at dive courses, etc.).

The G2TEK has a stop timer integrated into the Scuba mode. The stop timer can be accessed by pressing the MORE button. When displayed, the stop watch counting can be reset by pressing the BOOK button. The timer starts counting at immersion.

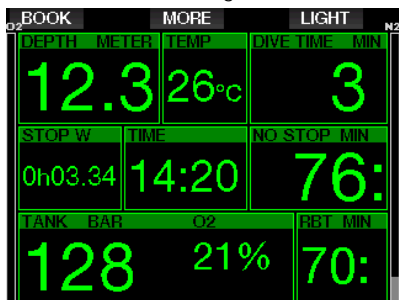

The stop timer generates a bookmark, which will appear on the dive profile in the LogTRAK.

3.7.4 Safety stop timer

If a minimum depth of 10m/30ft has been reached during the dive, at a depth of 5m/15ft the safety stop timer will automatically start a countdown. If you go below 6.5m/20ft, the timer will disappear and the no-stop time is shown again. Upon returning to 5m/15ft, the timer will start again automatically.

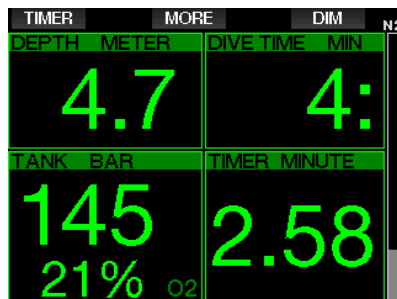

The safety stop timer can be restarted by pressing the TIMER button.

3.7.5 Backlight

In the menu **8.3 Backlight duration** you can select the time and function of the backlight. Normally the backlight is dimmed to low intensity and can be brightened by pressing the LIGHT button.

 **NOTE:** The display is totally off when the low power mode becomes active (only one battery segment is left) and by pressing the right button the display is illuminated for 10 seconds.

3.7.6 Compass

The compass can be activated during the dive by a press-and-hold of the LIGHT/DIM button. The display will change to the compass screen where a large compass rose is shown and the core numeric information of the dive.



3.8 Diving with GF settings

Prof. Albert A. Bühlmann, a name most divers know well, wrote the algorithms that continue to form the basis of decompression calculations today.

For over 20 years, UWATEC has been developing Bühlmann's algorithm and constantly adapting it to be state of the art. The result is the ZH-L16 ADT MB PMG algorithm, which is used in standard G2.

The technical diving community, in particular, finds that the Gradient Factors approach best suits their diving needs. So in an effort to address these preferences the G2TEK software uses GF settings.

Bühlmann created the ZH-L16C base algorithm. In the 90's Eric Baker presented the Gradient Factors (GF) approach, which provides additional options for increased conservatism. Gradient Factors can be set from no conservatism at all (100/100) to many different combinations.

In the Gradient Factor format "low/high" both values "low" and "high" present the per-centual amount of the base algorithm limiting M-value. The "low" generally defines the conservatism on fast compartments which will start desaturation at ascent first, whereas the "high" becomes dominant on shallower depths before surfacing. Due to many possible combinations it is possible to define your own decompressing strategy.

 **NOTE:** To learn more about Gradient Factors see the web articles "Clearing Up the Confusion" and "Understanding M-Values," both by Erik Baker.

WARNING

Selecting Gradient Factor values for diving requires advanced knowhow about decompression theories, their suitability for the planned dives and matching to your body. Wrong values can lead to DCS, permanent injury or death.

3.9 Gauge mode

Possible screen configurations in Gauge mode are Graphical and Classic. See menu **9.1. Screen configuration** to change between the modes.

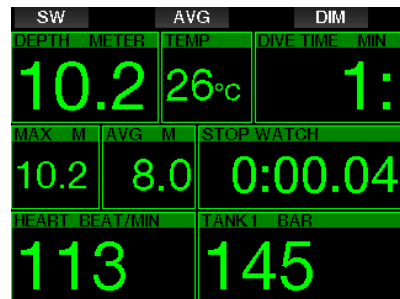
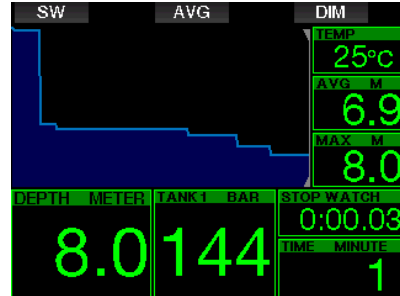

When the G2TEK is set to Gauge mode, it will only monitor depth, time, and temperature, and will not carry out any decompression calculations. You can only switch to Gauge mode if the computer is completely desaturated. All audible and visual warnings and alarms, other than the low battery, tank reserve, half tank, max depth max dive time and pressure signal alarm, are turned off.

WARNING

Dives in Gauge mode are performed at your own risk. After a dive in Gauge mode you must wait at least 48 hours before diving using a decompression computer.

When on the surface in Gauge mode, the G2TEK will show neither the remaining desaturation time nor the CNS O₂% value. It will, however, display a surface interval up to 24 hours and a 48-hour no-fly time. This

no-fly time is also the time during which you cannot switch back to computer mode.

The Gauge mode surface display after a dive shows the dive time in the top row. In the middle row the stopwatch is running from the dive start or last manual restart. In the bottom row the maximum depth of the dive is shown. After a 5-minute timeout the display changes to Gauge menu mode.

During a dive in Gauge mode, the G2TEK displays a stopwatch. This can be reset and restarted by pressing the SW button which also sets a bookmark.

With a press-and-hold of the SW button the gas switch procedure can be started. While in Gauge mode, the average depth can be reset. To reset the average depth, press the AVG button which also sets a bookmark.

With a press-and-hold of the AVG button the profile is displayed followed by the pictures.

Dimming the display screen is accomplished by pressing the DIM button. A press-and-hold of the DIM button will activate the compass display.



3.10 Apnea mode

The G2TEK has an advanced Apnea diving mode which can be enabled from the feature upgrade (see menu **8. Other settings**). The main features include a faster sampling rate than in Scuba mode along with alarm functions tailored specifically to Apnea diving.

The G2TEK measures the depth in Apnea mode every 0.25 seconds to ensure the precise maximum depth. In the logbook the data is saved in 1-second intervals. In Apnea mode it is also possible to start and stop the dive manually with a press-and-hold of the MENU button. This way you can use the G2TEK for static Apnea dives, where a normal dive start depth of 0.8 meters will not start a new dive.

As with Gauge mode, the G2TEK in Apnea mode doesn't carry out any decompression calculations. You can only switch to Apnea mode if the computer is completely desaturated.

Apnea mode at the surface after a dive shows the maximum depth and the dive duration. The surface interval counter starts after surfacing and the heart rate shows the current measured value.

Dive session values like water temperature, total dive time, number of dives and minimum heart rate are shown with white color as shown on the screen below.

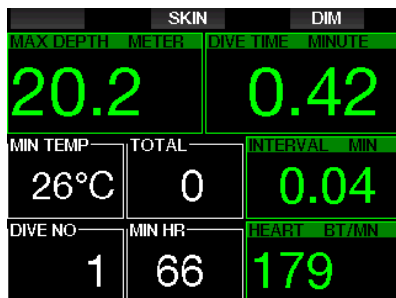

Apnea mode during the dive shows the current depth, dive time, ascent or descent speed, water temperature, maximum depth and heart rate.

SKIN		DIM	
DEPTH METER		DIVE TIME	MINUTE
16.5		0.25	
SPEED METER/SEC		TEMPERATURE	
0.2		26°C	
MAX DEPTH METER		HEART	BEAT/MIN
20.2		67	

By pressing the SKIN button the temperature measured from the heart rate belt will be shown in the window of the heart rate.

4. G2TEK ACCESSORIES

4.1 Bungee arm strap

Divers wearing thick neoprene wetsuits or drysuits may prefer bungee mounting instead of a standard arm strap. The G2TEK is designed so that bungees can be affixed at the corners of the device for maximum stability.

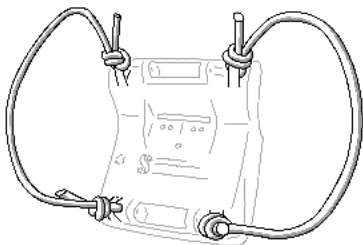

The arm strap can be removed by pressing the axle pins sideways through the bungee rings, with a maximum diameter of 1.9 mm/ 0.0748 inch pin punching tool.

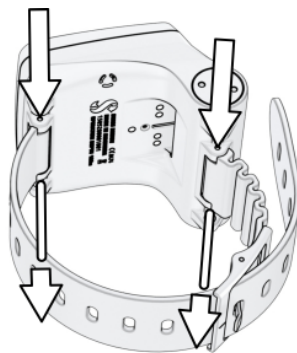

NOTE: Arm strap axle holes in the housing are not symmetric! When removing the arm strap axis, place the pressing tool from the smaller diameter side. Do not use the opposite side bungee ring as support when pressing the pin out.

4.2 Wireless high pressure transmitter

The G2TEK supports wireless tank pressure using Smart series transmitters. With the PMG function enabled you can use up to 8 transmitters with your G2TEK.

Additional transmitters can be purchased separately from your authorized SCUBAPRO dealer.



NOTE: There are 4 generations of Smart transmitters: Smart, Smart+ (longer distance), Smart+LED and Smart+ PRO. The G2TEK is compatible with all of these versions.

4.3 Digital Heart Rate Monitor

The new SCUBAPRO Digital Heart Rate Monitor is a wireless heart rate and skin temperature transmitter that forms an integral part of the functionality of a variety of compatible SCUBAPRO dive computers. The heart rate monitor allows you to measure and display heart rate and skin temperature in real time during diving.



The heart rate monitor must be paired with your G2TEK before the first use. After this initial pairing the heart rate monitor will be on standby and ready to send data. To establish the connection follow the steps below:

1. Remove the heart rate module from the elastic strap by unclipping it from the metal snap fastener.
2. Go to menu 8.10. Pair D-HR belt in your G2TEK. Make sure your G2TEK is in close proximity to the digital heart rate monitor when activating the pairing mode.
3. Place your thumbs on the two metal snap fasteners on the back of the transmitter module and check the indication displayed on your G2TEK's screen.
4. Save the pairing on your G2TEK with the right (SAVE) button.
5. Once a successful pairing with the digital heart rate monitor has been established, your G2TEK will display the following message: PAIRING TO HR-BELT SUCCESSFUL and the following screen will appear in the menu 8.10.

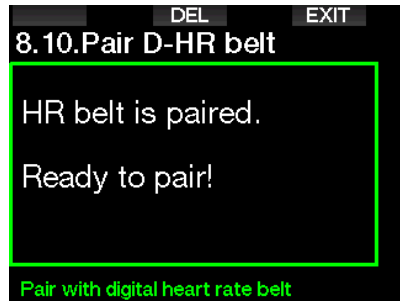

For more information on the operation and maintenance of the new Digital Heart Rate Monitor please refer to its user manual, available at www.scubapro.com/manuals.

4.4 Bluetooth USB stick

PC's with Bluetooth driver version lower than 4.0 require a generic Bluetooth dongle 4.0 or higher in combination with Windows operating system 8 or higher.

With older operating systems a BlueGiga type dongle is required.



NOTE: Laptops with an old internal Bluetooth module (a driver lower than 4.0) will require an external generic USB Bluetooth stick.

5. INTERFACES FOR THE G2TEK

The G2TEK dive computer can be connected to a desktop computer either via USB cable or Bluetooth connection.

5.1 USB connection

Connecting your G2TEK via USB cable to a PC/Mac enables a USB connection between the two devices. There are two modes that you can access via USB connection: LOG or DISK mode. These are described in detail in the following chapter.

Clean and dry the USB contact pins with a soft towel before connecting the G2TEK to the USB cable.



WARNING

Dirt on any contact surfaces may increase the electrical resistance and burn/harden the dirt so that it is difficult to remove afterwards. To enjoy trouble-free operation and a long service life, clean the contacts of your G2TEK before charging.

WARNING

Always connect the G2TEK to the USB cable in a dry and clean environment.

The connector will be pressed in through the gap which is behind the buttons.

The correct method for inserting the connector is shown in the pictures below.

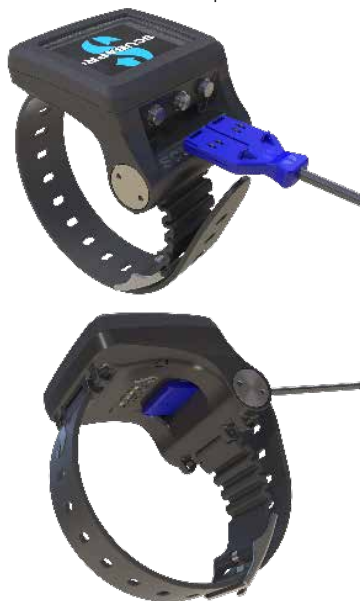

USB flash disk operations

When connecting the USB cable to your G2TEK the following screen will appear on its display:

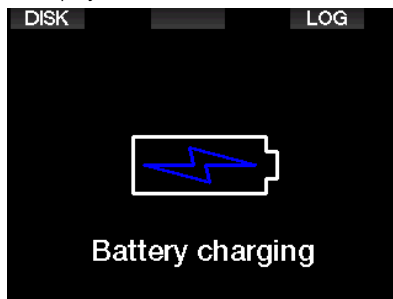

Here you can choose to access your G2TEK in DISK or in LOG mode. Accessing the flash disk via LOG mode enables you to connect your dive computer to LogTRAK, where you can download and analyze your dives. See chapter INTRODUCTION TO LOGTRAK to learn more about the functions of LogTRAK. By pressing the DISK button the G2TEK will display the following screen:

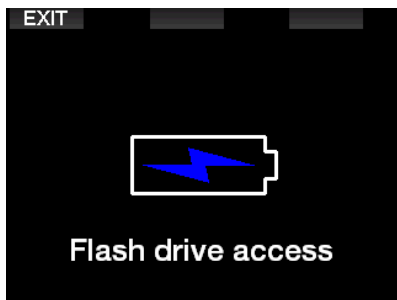

Your PC or Mac will detect the G2TEK flash memory as a normal USB memory stick. You can now select the G2TEK flash disk in your file explorer.

There are 3 folders on the G2TEK's flash disk: Logbooks, Pictures and System.

⚠ WARNING

Do not erase any of the system folders from your G2TEK! Removing system folders will lead to a malfunctioning G2TEK. Diving with a G2TEK is not safe if data has been removed.

The logbook folder is a hidden file. You can make a backup copy of it, but you should not remove it.

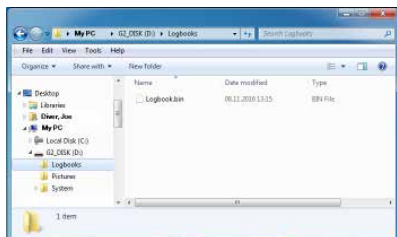

You can store pictures that the G2TEK can display during diving in the Pictures folder.

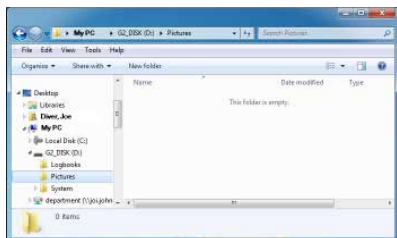

The G2TEK supports the following formats: jpg, bmp and gif. Pictures can be stored in a maximum of 320 x 240 pixels size format. In the System folder there are several sub folders.

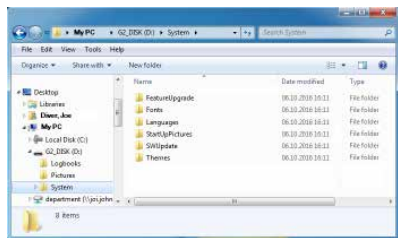

You can copy data that is provided at www.scubapro.com to the following folders for added functionality, or to receive updates:

- FeatureUpgrade
- Fonts
- Languages
- SWUpdate
- Themes

You can personalize your G2TEK start-up by storing a custom picture in the **StartUpPictures** folder.

5.2 Bluetooth connection

When you select menu **12. Bluetooth**, the Bluetooth function will be enabled and “State: Initializing” will be shown for a few seconds. After this, the G2TEK is ready for communication. Bluetooth is active only when this menu is displayed.

Set the device to which you want to connect your G2TEK to scanning mode. Once you’ve selected contact with your G2TEK, a randomly generated pin code appears on the G2TEK’s display screen as shown below.

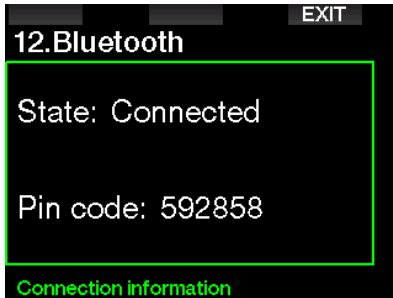

When the code is accepted by the other device, the link is ready for communication and the following display is shown on the G2TEK’s screen.

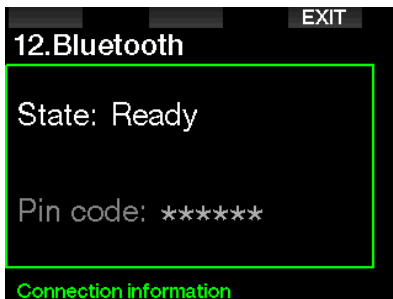

 **NOTE:** the G2TEK has a timeout of 3 minutes for a non-active Bluetooth connection. After this interval the G2TEK will disable Bluetooth and return to the normal time-of-day screen to save energy.

6. INTRODUCTION TO LOGTRAK

SCUBAPRO LogTRAK is an advanced tool for keeping track of your dives. It is available for desktop computers (Windows and Mac) as well as for mobile devices (Android and iOS).

6.1 LogTRAK desktop version

You can use either Bluetooth or USB communication to connect to the desktop version of LogTRAK.

To start the communication via USB:

1. Connect your G2TEK with the USB cable to your PC or Mac and press the LOG button

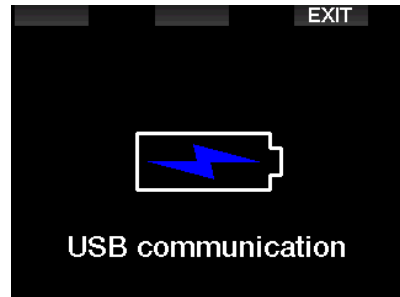

2. Launch LogTRAK on your desktop computer.
3. Check that the G2TEK is detected by LogTRAK. Extras -> Options -> Download
4. If it is not automatically detected, run the “Rescan plugged device.”

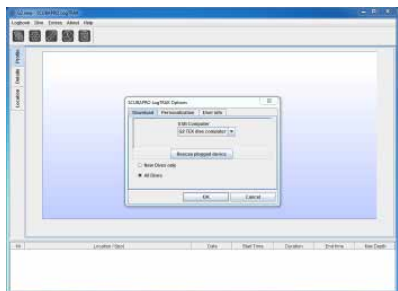

The desktop version of LogTRAK offers the following main functions:

- Download dives.
- Import and export dive profiles.
- Access device information (ID, hardware and software versions etc.)
- Enable/disable warnings
- Enter owner and emergency contact information.
- User information (gender, birthday etc.)
- Unit settings (metric / imperial)

6.1.1 Download dive profiles

From LogTRAK, by selecting Dive -> Download Dives you can transfer the G2TEK Logbook to your PC/Mac.

There are three main views, each showing a specific part of your dive logs:

1. Profile, showing the graphical data of the dive.
2. Details about the dive, where you can edit, for example, the equipment and tank information.
3. Location, which shows your dive site on the world map.

The selection tabs for views are on the left side of the main window.

To learn more about these views go to Help -> Help Contents or press F1 in LogTRAK.

6.1.2 Changing warnings/settings on the G2TEK, and reading computer info

By selecting Extras -> Read dive computer settings, you can enable/disable warnings that cannot be changed on the actual G2TEK unit via the menu system.

Read chapter: **Warnings and alarms** about the possible selections that you can modify on your G2TEK.

6.1.3 Owner and emergency information

Here you may enter or edit your own contact information and/or an emergency contact information.

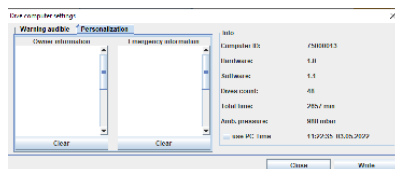

6.1.4 Personalization

You may also change the units between metric/imperial. Select Extras -> Options -> Personalization:

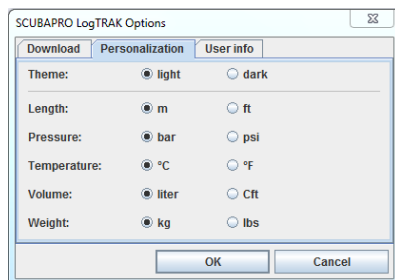

6.1.5 User info

Here you may enter or change information about the user. Select Extras -> Options -> User info:

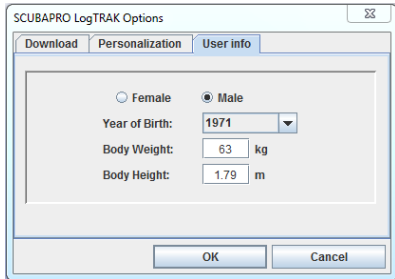

6.2 SCUBAPRO LogTRAK 2.0 mobile application

SCUBAPRO LogTRAK 2.0 is the mobile dive logbook for Android and iOS devices. LogTRAK 2.0 allows you to download and analyze your dive profile data on most mobile devices. You can download the application from the App Store for iOS and from the Google Play Store for Android.

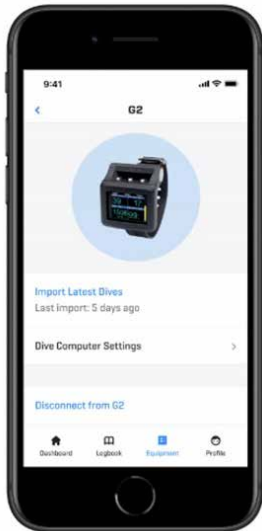

To establish connection with your G2TEK, you need to enable Bluetooth on your mobile device and set your dive computer to Bluetooth mode.

LogTRAK 2.0 is the perfect way to view your dives, keep them organized on your

mobile device and easily access them wherever you go.

Features include:

- Download and manage your dives
- Analyze data like depth, temperature and heart rate profile
- Incorporate additional dive information
- Adjust dive computer settings from your mobile device
- Update dive computer firmware from your mobile device

7. TAKING CARE OF YOUR G2TEK

7.1 Technical information

Operating altitude:

- with decompression – sea level to approximately 4000m/13300ft.
- without decompression (Gauge mode) – at any altitude.

Max operating depth:

- 120m/394ft; resolution is 0.1m until 99.9m, and 1m at depth deeper than 100m. Resolution in feet is always 1ft. Accuracy complies with EN13319 and ISO 6425.

Decompression calculation range:

- 0.8m to 120m / 3ft to 394ft.

Clock:

- quartz clock, time, date, dive time display up to 999 minutes.

Oxygen concentration:

- adjustable between 8% and 100%.

Helium concentration:

- adjustable between 0% and 92%.

Operating temperature:

- 10C to +50C / 14F to 122F.

Power supply:

- Li-Ion battery, user chargeable via USB.

Operation time with fully charged battery:

- Up to 50h. Actual battery operation time depends mainly on the operation temperature and backlight settings, but also many other factors.

Bluetooth® transceiver:

Operating frequency 2402-2478 MHz, max power < 3 dBm, connection range approx. 2m.

7.2 Maintenance

The G2TEK's depth accuracy should be verified every two years by an authorized SCUBAPRO dealer.

The tank pressure gauge and the parts of this product used to measure tank pressure should be serviced by an authorized SCUBAPRO dealer every other year, or after 200 dives (whichever comes first).

Aside from that, the G2TEK is virtually maintenance-free. All you need to do is rinse it carefully with fresh water after each dive and charge the battery when needed. To avoid possible problems with your G2TEK, the following recommendations will help assure years of trouble-free service:

- Avoid dropping or jarring your G2TEK.
- Do not expose your G2TEK to intense, direct sunlight.
- Do not store your G2TEK in a sealed container; always ensure free ventilation.
- If there are problems with the water or USB contacts, use soapy water to clean your G2TEK and dry it thoroughly. Do not use silicone grease on the water contacts!
- Do not clean your G2TEK with liquids containing solvents.
- Check the battery capacity before each dive.
- If the battery warning appears, charge the battery.
- If any error message appears on the display, take your G2TEK back to an authorized SCUBAPRO dealer.

7.3 Replacing the battery in the high-pressure transmitter

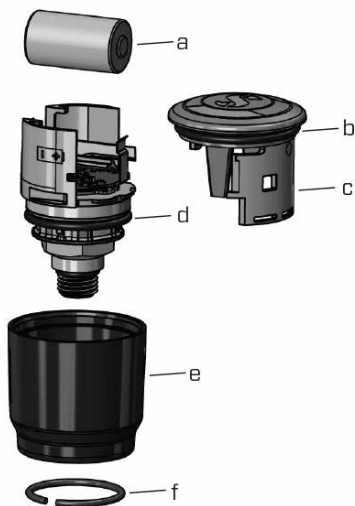

⚠ WARNING

We recommend having the battery of the transmitter replaced by an authorized SCUBAPRO dealer.

The change must be made with particular care in order to prevent water from seeping in. The warranty does not cover damages due to improper replacement of the battery.

- Remove the transmitter from the HP port of the first stage regulator.
- Dry the transmitter with a soft towel.
- Remove the lock ring with a pair of ring pliers. (f)
- Slide the outer sleeve downwards. (e)
- Remove the transmitter lower and upper O-Ring. (b & d)
- Slide the lid to the side (c)
- Remove the battery cap. (a)
- Insert new battery and new O-rings.
- Wait 30 seconds.
- Carefully slide back the lid onto the housing. Make sure that the lid is slid exactly up to the stop on the core part. Check the fits of the two O-rings. Then

slide back the outer sleeve towards the stop of the lid.

- Install the lock ring. Carefully check the fit of the lock ring. It must be located perfectly inside the groove.

NOTE: For best results use the transmitter battery set available at your authorized SCUBAPRO dealer.

7.4 Replacing the battery in the Digital Heart Rate Monitor

The digital heart rate monitor is powered by a user-replaceable CR2032 type lithium battery. However, in order to avoid leakage by incorrect closure of the battery cap, we recommend having the battery replaced by an authorized SCUBAPRO dealer.

The following parts of the heart rate monitor are shown in the drawing below:

1. battery cap screws
2. battery cap
3. O-ring
4. CR2032 battery
5. heart rate monitor module

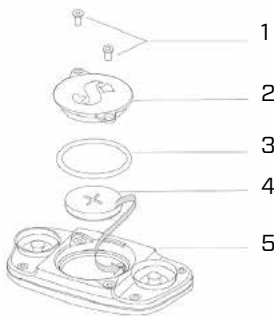

To change the battery in the heart rate monitor:

- Dry the module of the heart rate monitor with a soft towel if wet
- Open the battery cap by removing the screws
- Replace the O-ring (replacement O-rings are available from your authorized SCUBAPRO dealer)
- Remove the empty battery and recycle it in an environmentally friendly way
- Insert the new battery. Note the polarity,

“+” is marked on the body. Do not touch poles or contacts with bare fingers

- Close the battery cap

7.5 Warranty

The G2TEK has a 2-year warranty covering defects in workmanship and functioning. The warranty only covers dive computers which have been bought from an authorized SCUBAPRO dealer. Repairs or replacements during the warranty period do not extend beyond the warranty period itself.

Excluded from warranty coverage are faults or defects due to:

- Excessive wear and tear.
- Exterior influences, e.g. transport damage, damage due to bumping and hitting, influences of weather or other natural phenomena.
- Servicing, repairs or the opening of the dive computer by anybody not authorized to do so by the manufacturer.
- Pressure tests which do not take place in water.
- Diving accidents.
- Opening the G2TEK housing or metal cap on the side of the G2TEK.
- Commercial use.
- Exposing the unit to chemicals which include but are not limited to mosquito repellents and sunscreen.
- Repairing with unauthorized spare parts.
- Using any software or accessory which is not supplied by the manufacturer.



For European Union markets, the warranty of this product is governed by European

legislation in force in each EU member state.

All warranty claims must be returned with dated proof-of-purchase to an authorized SCUBAPRO dealer. Visit www.scubapro.com to find your nearest dealer.

8. COMPLIANCE

8.1 CE regulatory notices



8.1.1 EU Radio Equipment Directive

Hereby, Uwatec AG, declares that the radio equipment type PAN1740 is in compliance with Directive 2014/53/EU.

8.1.2 EU Personal Protective Equipment Regulation

The combination of SCUABPRO G2TEK and SCUBAPRO high pressure transmitter is a personal protective equipment in compliance with the essential safety requirements of the EU Regulation 2016/425. The notified body no.0474, RINA SpA, Via Corsica 12, I-16128 Genoa, has completed the EC type-examination to the combination mentioned above and assured the conformity with the European Standard EN250:2014. The certification is up to a depth of 50m as defined in the EN250:2014.

8.1.3 EU Depth Gauge Standard

The G2TEK dive instrument is also compliant with the European standard EN13319:2000 (EN 13319:2000 – Depth gauges and combined depth and time measuring devices – Functional and safety requirements, test methods).

8.1.4 EU Electromagnetic Compatibility Directive

The G2TEK dive instrument is also compliant with the European Union directive 2014/30/EU

8.1.5 EU Declaration of Conformity

The full text of the EU declaration of conformity is available at www.scubapro.com/declarations-conformity

8.2 FCC & ISED regulatory notices

8.2.1 Modification Statement

Uwatec has not approved any changes or modifications to this device by the user. Any changes or modifications could void the user's authority to operate the equipment.

8.2.2 Interference Statement

This device complies with Part 15 of the FCC Rules and Industry Canada license-exempt RSS standard(s). Operation is subject to the following two conditions: (1) this device may not cause interference, and (2) this device must accept any interference, including interference that may cause undesired operation of the device.

8.2.3 Wireless Notice

This device complies with FCC/ISED radiation exposure limits set forth for an uncontrolled environment and meets the FCC radio frequency (RF) Exposure Guidelines and RSS-102 of the ISED radio frequency (RF) Exposure rules. This transmitter must not be co-located or operated in conjunction with any other antenna or transmitter.

The G2TEK contains FCC ID: TVV1740.

8.2.4 **FCC Class B Digital Device Notice**

This equipment has been tested and found to comply with the limits for a Class B digital device, pursuant to part 15 of the FCC Rules. These limits are designed to provide reasonable protection against harmful interference in a residential installation. This equipment generates, uses and can radiate radio frequency energy and, if not installed and used in accordance with the instructions, may cause harmful interference to radio communications. However, there is no guarantee that interference will not occur in a particular installation. If this equipment does cause harmful interference to radio or television reception, which can be determined by turning the equipment off and on, the user is encouraged to try to correct the interference by one or more of the following measures:

1. Reorient or relocate the receiving antenna.
2. Increase the separation between the equipment and receiver.
3. Connect the equipment into an outlet on a circuit different from that to which the receiver is connected.
4. Consult the dealer or an experienced radio/TV technician for help.

8.2.5 **CAN ICES-3 (B) / NMB-3 (B)**

This Class B digital apparatus complies with Canadian ICES-003.

8.3 **Date of manufacture**

The manufacturing date can be determined from your device's serial number. The serial number is always 13 characters long: YYMMDDXXXXXX.

In the serial number the first two digits (YY) represent the year, the third and fourth (MM) the month, and the fifth and sixth (DD) the day when the device was manufactured.

8.4 **Manufacturer**

UWATEC AG
 Bodenaeckerstrasse 3
 CH-8957 Spreitenbach
 SWITZERLAND



Your dive instrument is manufactured with high-quality components that can be recycled and reused. Nevertheless, these components, if not properly managed in accordance with the regulations on electrical and electronic equipment waste, are likely to cause harm to the environment and/or to human health. Customers living in the European Union can contribute to protecting the environment and health by returning old products to an appropriate collection point in their neighbourhood in accordance with EU Directive 2012/19/UE. Collection points are provided by some distributors of the products and local authorities. Products marked with the recycling symbol on the left must not be disposed of in normal household waste.

9. GLOSSARY

AMD	Absolute Minimum Depth, the depth where a mix can be started to be used based on its oxygen content
AVG	Average depth, calculated from the beginning of the dive or from the time of reset
CNS O ₂	Central Nervous System oxygen toxicity
DESAT	Desaturation time. The time needed for the body to completely eliminate any nitrogen taken up during diving
Dive time	The time spent below a depth of 0.8m/3ft
Local time	the time in the local time zone
Max depth	Maximum depth attained during the dive
GF:	Gradient Factor. Gradient factors are a way to introduce conservatism to the base algorithm and they are expressed in % values in format low/high
MOD:	Maximum Operating Depth. This is the depth at which the partial pressure of oxygen (ppO ₂) reaches the maximum allowed level (ppO ₂ max). Diving deeper than the MOD will expose the diver to unsafe ppO ₂ levels
Nitrox:	A breathing mix made of oxygen and nitrogen, with the oxygen concentration being 22% or higher. In this manual, air is considered as a particular type of nitrox
NO FLY	Minimum amount of time the diver should wait before taking a plane
No-stop time:	This is the time that a diver can stay at the current depth and still make a direct ascent to the surface without having to perform decompression stops
O ₂ :	Oxygen.
O ₂ %:	Oxygen concentration used by the computer in all calculations
ppO ₂ :	Partial pressure of oxygen. This is the pressure of the oxygen in the breathing mix. It is a function of depth and oxygen concentration. A ppO ₂ higher than 1.6bar is considered dangerous
ppO ₂ max:	The maximum allowed value for ppO ₂ . Together with the oxygen concentration, it defines the MOD
Press:	The act of pressing and releasing one of the buttons
Press-and-hold:	The act of pressing and holding one of the buttons for 1 second before releasing it
INT.:	Surface interval, the time from the moment the dive is closed
SOS mode:	The result of having completed a dive without respecting all mandatory decompression obligations
Stopwatch:	A stopwatch, for example, to time certain legs of the dive
Switch depth	The depth at which the diver plans to switch to a higher oxygen concentration mix while using the multi-gas option
UTC:	Universal Time Coordinated, refers to time zone changes when traveling
TAT:	Total Ascent Time

RBT:	Remaining Bottom Time
CCR:	Closed Circuit Rebreather
Trimix:	A gas mixture containing Oxygen, Helium and Nitrogen
PMG:	Predictive Multi-Gas
OTU:	Oxygen Toxicity Unit