



SCUBAPRO

BCS MANUAL

SCUBAPRO.COM

**DEEP
DOWN
YOU
WANT
THE
BEST**

SUBSIDIARIES

SCUBAPRO AMERICAS

Johnson Outdoors Diving LLC
1166-A Fesler Street
El Cajon, CA 92020 - USA

SCUBAPRO ASIA PACIFIC

608 Block B, M.P.Industrial
Centre
18 Ka Yip Street, Chaiwan
Hong Kong

SCUBAPRO AUSTRALIA

Unit 21 380 Eastern Valley Way
Chatswood NSW 2067-
Australia

SCUBAPRO FRANCE

(France, UK, Spain, Export:
Netherlands, Belgium, Scandinavia)
Nova Antipolis Les Terriers Nord
175 Allée Belle Vue
06600 Antibes - France

SCUBAPRO GERMANY & E. Europe

Johnson Outdoors
Vertriebsgesellschaft mbH
Bremer Straße 4
90451 Nuremberg
GERMANY

SCUBAPRO ITALY

Via Tangoni, 16
16030 Casarza Ligure (GE) - Italy

SCUBAPRO SWITZERLAND

Bodenackerstrasse 3
CH-8957 Spreitenbach
Switzerland

SCUBAPRO BCS MANUAL

Congratulations on purchasing a SCUBAPRO Buoyancy compensator (BC) and welcome to SCUBAPRO. We are confident that you will enjoy extraordinary performance from our BC, designed and manufactured using the most advanced technology.

We thank you for choosing SCUBAPRO and wish you a future of safe dives and underwater enjoyment!

TABLE OF CONTENTS

1. IMPORTANT WARNINGS	4
2. EUROPEAN CERTIFICATION	4
3. IMPORTANT CAUTIONS	5
4. GENERAL INFORMATION	6
5. INITIAL SET UP	6
5.1 Super cinch Q.A. (quick ajust.): cylinder strap set-up and attachment (single tank, some models).....	7
5.2 Standard cinch: cylinder strap set-up and attachment (single tank, some models) .	8
5.3 Additional tank strap (some models)	9
6. SET UP FOR DOUBLE SCUBA CYLINDERS (P/N 20.040.000) (some models: see models features)	9
7. BALLASTING SYSTEM	10
7.1 Standard weight belt.....	10
7.2 Integrated Weight Pocket System (BW) (proprietary) (some models: see models features).....	10
7.3 Back counter Weight Pockets (some models: see model features).....	11
7.4 Trim Weight Pockets kit (some models: see models features).....	11
8. VALVE SET UP	12
9. OPERATION	12
9.1 Inflation.....	12
9.2 Deflation	13
10. BC HARNESS ADJUSTMENT - GENERAL FEATURES	14
11. BC EXAMINATION AND PROCEDURES	15
12. STORAGE	16
13. GENERAL SPECIFICATIONS	17
14. X-BLACK	18
15. T-ONE	19
16. GO	20
17. MASTER JACKET	21
18. SEAHAWK LITEHAWK	23
19. CLASSIC - CLASSIC UNLIMITED - CLASSIC EXPLORER	25
20. LEVEL	27
21. BELLA	28
22. GLIDE	29
23. HYDROS PRO	30
24. HYDROS X	32

1. IMPORTANT WARNINGS

WARNING

This manual must be read and understood entirely before using the product. It is advised that you keep this manual in your possession during the entire life of your BC. FAILURE TO READ, UNDERSTAND, AND FOLLOW THE PRECAUTIONS LISTED IN THIS MANUAL COULD RESULT IN SERIOUS INJURY OR DEATH.

WARNING

When diving you must follow the rules and apply the skills taught by a recognized scuba diving certification agency. Before taking part in any diving activity, it is mandatory to have successfully completed a scuba diving course covering both theoretical and technical aspects of diving.

WARNING

This instruction manual does not replace a diving instruction course!

2. EUROPEAN CERTIFICATION

All SCUBAPRO BCs described in this manual have obtained the European certification according to European rules regulating the conditions for the release on the market and the fundamental safety requirements for second category Personal Protective Equipment (PPE). Certification tests have been conducted according to the EN1809 harmonized standard, to ensure the compliance of the products to the fundamental requirements for health and safety set by European regulation 2016/425/EU.

The CE and EN1809 marks on the product denote the conformity to said requirements.

The Manufacturer of SCUBAPRO BCs is:

SCUBAPRO EUROPE Via Tangoni 16 16030 Casarza Ligure (GE) Italy, or SCUBAPRO GERMANY & E. Europe Johnson Outdoors Vertriebsgesellschaft mbH Bremer Straße 4 90451 Nuremberg GERMANY

WARNING

THIS BC IS NOT A LIFEJACKET OR A RESCUE DEVICE.

Emergency face up floatation may not be provided for all wearers and in all conditions.

WARNING

Ensure you have fully understood the jacket's function and features and adjust the straps appropriately before diving. If in doubt, ask your official SCUBAPRO dealer for help.

WARNING

This BC is not a breathing device.

Never breathe from the BC.

Your BC may contain gas residue, liquid, or contamination that may result in injury or death if inhaled.

**WARNING**

In accordance with European standards, our BCs can only be considered certified where all components are present, as per the original SCUBAPRO configuration, including the low pressure hose supplied.

Any variation of the original configuration invalidates conformity to European certification standards.

3. IMPORTANT CAUTIONS

For your protection while using SCUBAPRO life support equipment, we call your attention to the following:

1. Use the equipment according to the instructions contained in this manual and only after having completely read and understood all instructions and warnings.
2. Use of the equipment is limited to the uses described in this manual or for applications approved in writing by SCUBAPRO.
3. Cylinders must only be filled with atmospheric compressed air, according to the EN 12021 norm. Should moisture be present in the cylinder, beside causing corrosion of the cylinder, it may cause freezing and subsequent malfunction of the regulator during dives carried out in low temperature conditions (lower than 10°C (50°F)). Cylinders must be transported according to local rules provided for the transport of dangerous goods. Cylinder use is subjected to the laws regulating the use of gases and compressed air.
4. Equipment must be serviced by qualified personnel at the prescribed intervals. Repairs and maintenance must be carried out by an Authorized SCUBAPRO Dealer service facility and with the exclusive use of original SCUBAPRO spare parts.
5. Should the equipment be serviced or repaired without complying with procedures approved by SCUBAPRO or by untrained personnel or not certified by SCUBAPRO, or should it be used in ways and for purposes other than specifically designated, liability for the correct and safe function of the equipment transfers to the owner/user.
6. The content of this manual is based upon the latest information available at the time of going to print. SCUBAPRO reserves the right to make changes at any time.
7. All dives must be planned and carried out so that at the end of the dive the diver will still have a reasonable reserve of air for emergency use. The suggested amount is usually 50 bars (725 psi).

SCUBAPRO refuses all responsibility for damages caused by non-compliance with the instructions contained in this manual. These instructions do not extend the warranty or the responsibilities stated by SCUBAPRO terms of sales and delivery.

**WARNING**

Always perform a pre-dive and post-dive inspection of the BC.

4. GENERAL INFORMATION

Primary purpose of the Buoyancy Compensator

The primary purpose of a Buoyancy Compensator is to make you more comfortable by enabling you to maintain neutral buoyancy at depth.

You are neutrally buoyant when you maintain a specific depth without expending significant physical effort to prevent an ascent or descent from that depth.

! WARNING

Do not use your BC as an assist or “lift bag” for bringing objects to the surface. These objects may be lost during the ascent, creating a sudden increase in buoyancy and loss of buoyancy control.

5. INITIAL SET UP

Low Pressure (LP) hose

Connect the low pressure (LP) hose of the Power Inflation Valve or A.I.R. 2 to an unused LP port of the first stage, **that must have the same thread** (fig. 1).

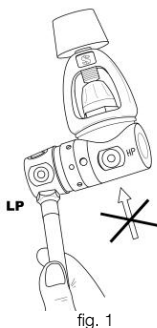

fig. 1

! WARNING

Do not attach a L.P. hose to a SCUBA regulator high pressure (HP) port or to an air supply with pressure in excess of 200 psi (13.8 bar). This may result in damage or explosive failure of the Inflation Valve or Low pressure Hose, which could result in injury or death.

5.1 Super cinch Q.A. (quick ajust.): cylinder strap set-up and attachment (single tank, some models)

The SCUBAPRO Super Cinch Q.A. cylinder strap allows you to easily fasten your BC to any single SCUBA cylinder.

Set up for a single SCUBA cylinder must be accomplished following these steps:

1. Wet the webbing of the Super Cinch Q.A. cylinder strap prior to tightening. Wrap the Super Cinch Q.A. (W1) strap (fig. 2 – 1) around the SCUBA cylinder and insert the end of the stainless steel buckle (B) into the trapezoidal “D” ring (DR1) (fig. 2 – 1). Position the SCUBA cylinder so that the cavity (S) of the back plate corresponds to the cylinder shoulder (fig. 2 – 2) with the lever (B) close to the back pack (BP) (fig. 2 – 3). The cylinder locator strap (L) (fig. 2 – 2), on the top of the back plate, encircling the valve neck of the cylinder, prevents the back pack strap assembly from sliding down, while connecting and tightening the Super Cinch Q.A. Once correctly adjusted, it helps to easily and consistently find the correct position.
2. Close the buckle (C) (fig. 2 – 3). If the webbing strap is too tight to close or too loose to grab the SCUBA cylinder, open the hook and loop fastener on the webbing and readjust the length of the Super Cinch Q.A. (W1) webbing (fig. 2 – 1). For extra safety, slide the loop (SL) (fig. 2 – 1) around the webbing end (T). With SCUBA cylinder in place, lift the assembly by the back pack handle and shake firmly to check for secure fastening. Try to move the backpack up and down on the SCUBA cylinder. If there is movement, the band is not tight enough.

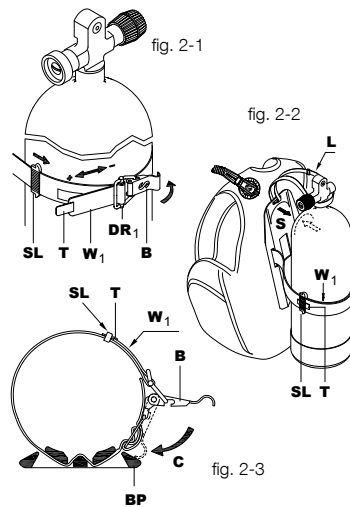

5.2 Standard cinch: cylinder strap set-up and attachment (single tank, some models)

The SCUBAPRO® standard cinch lets you quickly release any single tank from the BC vest. It must be installed as follows:

1. Rotate the buckle until it snaps into the open position. Slide the strap around the plastic buckle as shown in the figure (Fig. 2-4), wet the strap before clamping it in place on the tank, and adjust the length (Fig. 2-7).
2. If the BC has a hard backplate, place the cavity (S) of the backplate on the shoulder of the tank (Fig. 2-6) and then fasten the strap (Fig. 2-5 and 2-7) of the quick-release belt (W1) around the tank.

On BCs with hard backplates, the safety strap (L) (Fig. 2 – 6) is fastened at the top of the backplate to prevent the BC from slipping downward while the strap is fastened and closed. Once adjusted correctly, it helps relocate the right position for the tank on the BC in an easy, repetitive way.

3. Close the buckle (C) (Fig. 2 – 7). If the strap is too tight or too loose, open the hook and loop strap and the buckle to readjust the length of the strap (Fig. 2-5) of the quick-release belt (W1). For added safety, slide the loop (SL) (Fig. 2-5) around the strap end (T). In BCs with a hard backplate, with the tank mounted to the BC you can lift the entire unit using the handle integrated into the backplate.

Shake the unit to ensure the tank is properly fastened.

In BCs without a hard backplate, there is a second hook and loop strap that allows you to easily position the tank to prevent unwanted shifting during the dive.

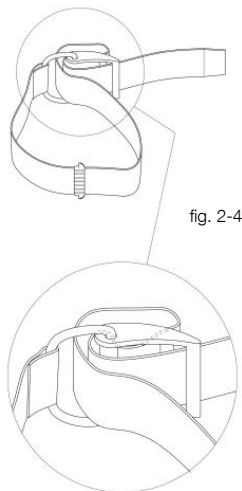

fig. 2-4

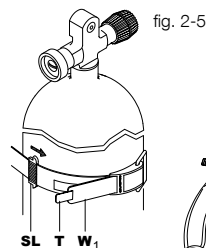

fig. 2-5

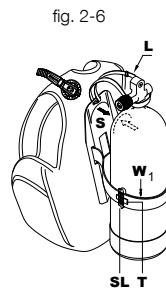

fig. 2-6

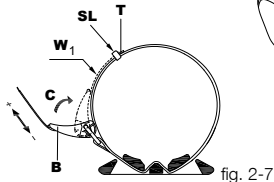

fig. 2-7

⚠ WARNING

To prevent accidental loss of the cylinder, ensure the strap is done up tightly enough so that the cylinder cannot move or slide on the BC. Failure to do so could result in injury or death.

⚠ WARNING

Soak the webbing of the SCUBA air cylinder strap and then tighten prior to each use of the BC. Webbing may stretch when initially exposed to water. Failure to soak the webbing may allow the cylinder strap to loosen around the SCUBA air cylinder. This could result in injury or death.

5.3 Additional tank strap (some models)

Some BC models feature a small tank holder backpack to achieve an easier folding and storage. These BCs include an additional stabilizing tank strap located above the main straps described in previous chapters to ensure proper cylinder mounting.

In these models it is recommended to fasten the tank straps in such a way that the main strap (lower) is positioned in the lower half of the tank and the additional stabilizing strap (upper) just above it (see picture 2-8) in the constant diameter tank area.

Positioning the additional stabilizing strap too high may result in it slipping off the upper tank, so the tank is not properly secured to the BC.

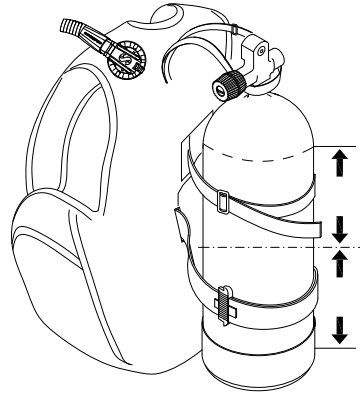

fig. 2-8

⚠ WARNING

Check the correct positioning and the correct tightening of the tank straps before starting to dive.

6. SET UP FOR DOUBLE SCUBA CYLINDERS (P/N 20.040.000) (SOME MODELS: SEE MODELS FEATURES)

SCUBAPRO offers a system to connect two tanks with an adjustable belt system, that allows to easily fasten and remove your BC from the double tanks (fig. 3).



fig. 3

7. BALLASTING SYSTEM

The total weight must be calculated and tested in order to maintain a neutral buoyancy since you change depth during the dive, by simply adding or releasing the correct amount of air. The SCUBAPRO BC has been designed for three ballasting systems, based on the use of the 'Ecoweight' (soft sealed weight) developed to improve comfort, to reduce wear of the pockets and to protect the environment as well.

7.1 Standard weight belt

It is the traditional harness weight belt, separate from the BC.

7.2 Integrated Weight Pocket System (BW) (proprietary) (some models: see models features) (fig. 4)

These removable pockets are inserted in the BC compartments (fig. 4-3) held in position by the buckle (fig. 4-4) with the strap pulled by the "D" ring; in case of need, by disengaging the buckle (fig. 4-5, 4-6) it is possible whether to release the weights for emergency or, simply, to transfer the weight pocket to the boat, at the end of the dive. See models features for maximum acceptable weight.

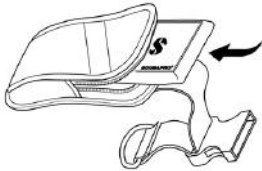

fig. 4-1



fig. 4-2

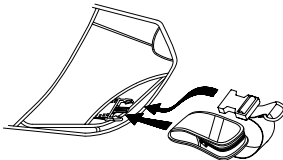

fig. 4-3

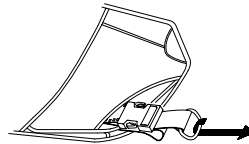

fig. 4-4

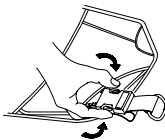

fig. 4-5

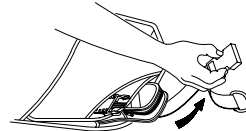

fig. 4-6

WARNING

The Ecoweight (fig. 4-1) and Removable Pocket (fig. 4-2) must be perfectly secured with the buckles fully and correctly engaged (fig. 4-4) : the loss of the pocket during diving causes positive buoyancy and uncontrolled ascent that could result in injury or death.

WARNING

Practice fastening and releasing the weight pockets several times before diving.

7.3 Back counter Weight Pockets (some models: see model features)

Top of the range SCUBAPRO BCs offer two counter weight pockets (fig. 5-CP₁).

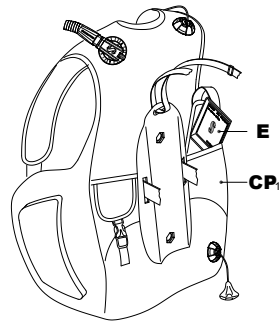

fig. 5

WARNING

Back counter weights are not designed to be released in an emergency. Failure to create adequate positive buoyancy in an emergency situation may result in injury or death. The user of the BC must configure the entire diving system in a manner that provides the means for rapidly and easily creating positive buoyancy as an aid for emergency ascent.

See models features for maximum acceptable weight.

7.4 Trim Weight Pockets kit (some models: see models features)

Some models offer the possibility to add an optional trim weight pockets kit to be attached to the backpack.

Each trim weight pocket can be loaded with up to 2.2 lb. (1 Kg) of SCUBAPRO Ecoweight.

WARNING

Contact an authorized SCUBAPRO Technical Service in order to assemble the kit properly.

8. VALVE SET UP

SCUBAPRO BCs are completed by the BPI System (Balance Power Inflator).

The BPI, connected to the tank/regulator, makes it possible to control buoyancy in the water (inflation/deflation of the BC) by using inflate and deflate buttons.

Alternatively, users can assemble the AIR2 system.

Connecting the BPI and/or AIR 2

The Power Inflation Valve allows you to inflate your BC using air from your SCUBA cylinder. Its LP hose, threaded on a LP port of the first stage regulator, is connected to the Power Inflation Valve by the Quick Disconnect Coupling that works with the air on or off.

To attach the Quick Disconnect Coupling (fig. 6 - C):

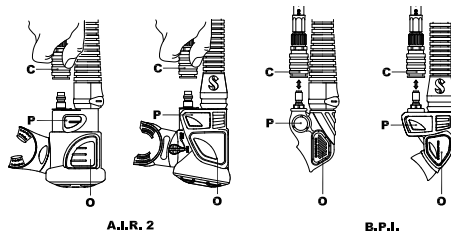

fig. 6

1. Make sure that both fittings are free of contamination prior to mating them together.
2. Pull back the collar of the Quick Disconnect Coupling, while pushing the hose firmly onto the fitting plug found on the power inflation valve.
3. Release the collar when the coupling is fully seated on the plug. Pull gently but firmly on the hose to check for a secure connection.
4. To disconnect, pull the Quick Disconnect Coupling collar back and disengage the LP hose from the plug.



WARNING

AIR2 uses a dedicated quick disconnect coupling.

When using AIR2 be sure to use only the SCUBAPRO dedicated hose supplied with the specific quick disconnect coupling.



WARNING

Keep water out of the inflatable aircell of the BC. Repeated use of the oral valve or the Overpressure Valve may allow water inside the BC, reducing the amount of buoyancy provided by the BC. This could result in injury or death. Drain all water out of the BC prior to every use.

9. OPERATION

9.1 Inflation

Inflating the BC with the Power Inflation Valve (on BPI and/or AIR2)

To inflate the BC, press the Power Inflation Valve Button (fig. 6-P). Air should enter the BC. For better control during inflation use short bursts of air by repeatedly pressing and releasing the PIV button.

Inflating the BC with the Oral Valve (on BPI and/or AIR 2)

The Oral Valve is found on the end of the airway. It allows you to inflate your BC with your exhaled breath. Use of this valve for inflation is recommended on the surface, or on land prior to diving. It may be used when you cannot, or do not wish to add air to the BC with the Power Inflation Valve.

1. First exhale a small amount of air into the mouthpiece of the valve to purge any water that may be trapped there.
2. With the same breath, continue to exhale while deeply depressing the Oral Inflation Valve Button (fig. 6 - O).
3. Release the Oral Valve Button when you inhale fresh air.
4. Repeat steps 2 and 3 until the desired amount of buoyancy is reached.

9.2 Deflation

Deflating the BC with the manual dump valve on the elbow

Stop and assume an upright position in the water. When in position, open the Manual Dump Valve by:

- a. pulling gently on the hose assembly (fig. 7 - A).
It is not necessary to use excessive pressure to pull on the hose assembly. Valve travel is limited and pulling harder will not increase the air flow. To close the Manual Dump Valve, stop pulling downward, and release.
- b. pushing on the button that protrudes out of the valve casing (fig. 7 - C) (Patented): this system could be useful also to purge air of another diver having problems (panic, beginner diver, unconsciousness, etc.).

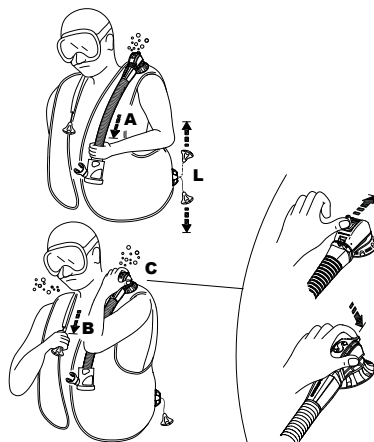

fig. 7

WARNING

Keep sand and other contamination out of the Oral Valve mouthpiece and valve button. Under certain conditions, contamination can cause the valve to not close completely. If this occurs while diving, shake the valve while depressing it several times. If the valve leaks or remains inoperable, terminate the dive. Diving with a leaking Buoyancy Compensator or with valves that do not operate properly may result in a loss of buoyancy control that could result in injury or death.

Deflating the BC with the Oral Valve (BPI and /or AIR 2)

Assume a head up position in the water. Raise the Oral Valve above and in front of your face. (This insures the Oral valve will be positioned above the air bubble in the BC.). Depress the Oral Valve button and visually confirm that air is escaping from the mouthpiece. For best control, let air out in a series of short, measured amounts while observing the effects on your buoyancy.

WARNING

- The SCUBAPRO® Dual Manual Dump Valve (Patent) has a safety hand button that releases air when pushed (fig 7-C), in case of failure of the Manual Dump System (broken cable, pin, etc.) or while breathing from an Air 2.
- With all deflation methods, hold the valve open no longer than needed. This helps prevent excess water from entering the BC.
- Do not depress the Oral Valve button when activating the Manual Dump valve, as water may enter the BC through the Oral Valve mouthpiece.

Shoulder valve (fig. 7-B)

The valve on the right shoulder, if present, is activated by pulling gently on the knob which is connected via a lanyard to the valve itself (fig. 7 - B). To operate either style of dump valve, orient the valve to a position higher than the air bubble in the BC. Activate the dump valve until the desired amount of buoyancy is reached. Stop pulling/pushing to close the valve (fig. 7 - B).

Lower Dump Valve (fig. 7 - L)

An over Pressure Valve located at the lower rear of the BC is equipped with lanyard and pull knob. This lower Dump Valve can be manually activated when the Diver operates them in a horizontal or head down orientation in the water, positioning them at the highest point of the air bubble.

WARNING

the deflation devices with the maximum outflow of gas are the shoulder valve fig. (7-B) and the lower valve (fig 7-L).

Over Pressure Valve Operation

The Over Pressure Valve prevents over-inflation of the BC. If the internal pressure exceeds the spring pressure in the Over Pressure Valve, the valve automatically opens and releases air to prevent damage to the BC. The valve will automatically close when the internal pressure goes below the spring pressure in the Over pressure Valve.

10. BC HARNESS ADJUSTMENT - GENERAL FEATURES

WARNING

Adjust the BC so that it does not restrict your breathing when fully inflated. Restriction of normal breathing while wearing your BC could result in injury or death. Before each use, check all bands, straps, quick-connect clips, and/or cummerbund for proper adjustment to the user.

Opening and securing the belts

In order to quickly open or close the jacket, quick-lock and -release buckles are used on both the shoulders and the cummerbund.

The cummerbund also features a hook and loop closure system.

Adjustable shoulder (some models: see model features)

Shoulder straps are adjustable on your BC. These straps adjust by a length of webbing passing through a locking feature on a quick release buckle. Tighten buckles by grasping the free end of the adjustment webbing and pulling firmly downward. Lift the front of the buckle upwards while wearing the BC to loosen.

A quick release feature may also be incorporated into the buckle. Check for two tabs on either side of the buckle that may be squeezed to separate the buckle halves.

Front and shoulder closures on the BC are used to keep it in a low drag configuration.

11. BC EXAMINATION AND PROCEDURES

Pre-dive, dive and post-dive BC examination helps to identify equipment problems before unsafe conditions exist, preventing diving accidents. All equipment must be regularly inspected by an authorized SCUBAPRO equipment repair facility.



WARNING

DO NOT DIVE with a BC that does not pass any of the Pre-Dive, Dive or Post-Dive inspection points and tests. Loss of buoyancy control or air holding integrity could occur, resulting in serious injury or death.

Pre-Dive Visual Inspection and Valve Test:

1. **Examine** the entire BC for cuts, punctures, frayed seams, excessive abrasion, loose/missing hardware and other damage of any kind.
2. **Check** the proper tightening of the dump valves and the elbow ring
3. **Inspect** the Oral Valve, Power Inflation Valve, Manual Dump Valve and Over Pressure Valve(s) for cracks, damage, or contamination.
4. **Operate** the Power Inflation Valve (with the LP hose attached and charged with air pressure), Oral Valve, manual Dump Valve and Over Pressure Valve, checking for proper operation and resealing. If the OP Valve has a Pull Dump, test it by pulling on the cord.
5. **Inflate** the BC through the Oral Valve until it is firm. Listen and check for leaks. Let the BC stand inflated for 30 minutes or more, then check the BC for loss of air.
6. **Soak** the cylinder band(s) and fit the BC to a SCUBA cylinder, pull up on the BC while attached on the SCUBA cylinder, checking that the BC will not slip while diving.
7. While wearing the BC, **adjust** the straps and other attachments on the BC for a comfortable fit that does not restrict breathing. Make these adjustments with the BC inflated and while wearing the exposure suit you intend to dive with.
8. **Check** quick release weight pockets or systems that retain weight (if your BC is equipped with them). Make sure that their retention systems are fully engaged and attached : they have to be released, and the weight removed from your equipment, quickly.
9. **Cross check** all valves' operation and visually inspect your BC with your dive partner before each dive, prior to entering the water.



WARNING

DO NOT DIVE with a BC that is damaged, leaks air, or does not function properly. Terminate any dive as safely and quickly as possible if the BC becomes damaged, leaks air, or does not function properly.

Post-Dive : BC Cleaning and examination and Storage

With proper care and service, your BC should provide years of enjoyment. Maintenance and care procedures must be observed and are as follows:

1. **Rinse the BC** thoroughly inside and out with fresh water after every use (do not use any aggressive solvent and/or cleansing liquid).
 - Fill the BC Inner Bladder, approximately 1/4 full with clean fresh water through the Oral valve.
 - Orally inflate the BC and shake to distribute water inside of the BC.
 - Hold the BC upside down, depress the Oral Valve Button, and allow all water and air to drain from the Oral Valve mouthpiece.
 - Repeat one or two more times.
 - Rinse the entire BC with fresh water by dipping in a tub or spraying with a hose.
 - Rinse all valves to make sure all sand and other debris is removed.
 - Disinfection: SCUBAPRO recommends McNett Revivex. Use according to the procedure and dilution described on its packaging.
2. **Dry the BC:** if hanging, make sure it is not in direct sunlight. Dry completely if storing, slightly inflated.

**WARNING**

Avoid prolonged or repeated exposure to chlorinated water, such as in swimming pools. Wash your BC immediately after any use in chlorinated water. Chlorinated water can oxidize fabrics and materials on your BC, thereby shortening their life, and cause colors (especially neon) to fade. Damage and fading from prolonged exposure to chlorinated water is specifically not covered under warranty.

12. STORAGE

Store your BC, after it has fully dried, by partially inflating and then placing it in a cool, dark, dry, location: ultraviolet rays will shorten the life of the fabric and cause colors to fade. Slightly grease (with SCUBAPRO Lubricant Grease), the AIR 2 and BPI couplings.

Inspection and Service Interval

Your BC should be inspected and maintained at an Authorized Service Center at least once a year, more often if you dive frequently. Any damage caused due to failure to properly maintain the BC is not covered by the warranty.

**WARNING**

Due to heavy usage, BCs used for rental/diving centres, professional purposes or other intensive use must be checked at least every 6 months. Overall conditions and main safety parts such as the bladder, valves, elbow, corrugated hose, BPI must be inspected. If any of the above parts shows wear or diminished performance it should be replaced immediately or removed from usage, if replacement is not possible.

13. GENERAL SPECIFICATIONS

Operating temperature range

Air	-20°C	to	+50°C	-4°F	to	122°F
Water	-2°C	to	+40°C	28°F	to	104°F



WARNING

Special Instruction in cold water diving methods, and the specific use of this product in cold water, is required prior to cold water diving (temperatures below 10°C/50° F). This instruction is beyond the scope of this manual.

Low pressure Hose / Pneumatic Inflation Valve

LP hose and Pneumatic Inflation Valve operating pressure	95 – 200 psi (6.5 – 13.8 bar)
Low Pressure Hose Fitting threads	3/8 – 24 UNF
O-Rings - Seals	EPDM – Buna/Nitrile - Silicone



WARNING

This product is designed to use air or helium/nitrogen/oxygen mixtures containing up to 40% oxygen. Use of gas mixtures with increased oxygen, or the addition of other substances, may cause corrosion, deterioration, premature aging or component failure of metal and rubber parts. These actions may result in loss of buoyancy control or air holding integrity of the BC, resulting in injury or death. Non-standard gas mixtures may also present a risk of fire or explosion.

14. X-BLACK

X-Black sets the new premium standard in Scubapro BC range. It's a deep evolution of former T-Black BC, keeping its best features and improving all the others including comfort and fit. This is an adjustable single-bag BC made of highly-resistant material (Cordura® 1000), covered in polyurethane, radio frequency welded. Two additional expandable volumes on the rear side between the bottle and diver back add amazing lift when needed. They are retractable thanks to elastic straps (Airflex Technology System) so they don't create any extra drag when deflated. The new X-Black features a bladder freely linked to harness in order to provide extra comfort.



Inflation makes the bladder move backward on the harness without squeezing diver body. Additional soft pads are located over the cummerbund area to provide extra comfort. New ergonomic backpack is light and soft with air-net inserts. Shoulder straps show ergonomic shape including soft pads where the dump valves are located and around the neck. They can be adjusted in length according the needs. The shoulder pads hold shaped ultra-light Aluminium D-rings. Their angular shape and their size make it easy to hook on accessories, especially heavy ones.

The large pockets, also made of Cordura® and air-net, provide excellent resistance and capacity. An extra right pocket houses the safety buoy, a spare mask or other accessories. The dynamic shape of the pockets is highlighted by fabric pattern including classic SCUBAPRO logo on one side and the new X-Black logo on the other.

Integrated weight system includes two new weight pockets on the front and rear air-net, pockets for integrated counterweights.

Two octopus pockets are located on the front to easily store and release octopus LP hose. Side grommets are standard for SCUBAPRO knife attachment.

Each pocket can be loaded with up to 11 lb (5 Kg) of SCUBAPRO Ecoweight above the size "M" and up to 5.5 lb (2.5 Kg) in the "S" and "XS" sizes (see assy procedure, fig. 4-1, 4-2). Each back pocket can be loaded with up to 5.5 lb. (2.5 Kg) SCUBAPRO Ecoweight. Performance is listed below and printed in the interior patch stitched on the BC.

Sizes	Max Lifting Buoyancy (N*)	Max Lifting Buoyancy (lb)	Max size of bottle (l)
S	170	38.2	18
M	200	44.9	
L	220	49.5	
XL	250	56.2	
XXL	290	65.1	

*N=Newton

15. T-ONE

T-one is the Scubapro jacket specifically designed for rental. Ideal for diving school it's based on a simple and reliable aircell. Materials and geometry are time proven to be suited for intensive use. The aircell made of EndurTex high tenacity nylon fabric, polyurethane coated and high frequency welded has been successfully laboratory stress-tested to exceed standard requirements.

It also features a backpadding covered in a specific hi-grip material to maximize comfort. The T-One has a color coded tag to easily identify the size.

The two octo pockets up front allow to easily store the octopus low pressure hose as well as the console.

It provides ample pockets with hook and loop lid closure.

A separate kit for trim weight is available and each of the two pockets can carry up to 2.2lb (1kg) of Ecoweight. The kit is to be installed by an authorized Scubapro dealer.



Performance is listed below and printed in the interior patch stitched on the BC.

Sizes	Max Lifting Buoyancy (N*)	Max Lifting Buoyancy (lb)	Max size of bottle (l)	Color Coord.
XXS	80	18.0	15	purple
XS	100	22.5		bronze
S	140	31.5		neon green
M	160	36.0	18	blue
L	180	40.5		neon yellow
XL	210	47.2		neon orange
XXL	240	54		dark grey

*N=Newton

16. GO

If you like to travel to your dive locations, our new SCUBAPRO GO travel BC is ready to go with you. GO is the ultimate answer to your dive travel needs: light and foldable yet complete with integrated front weight pockets.

A dedicated kit of trim weight pockets is also available.

It can be easily attached by a buckle.

Its modern and unique style matches the spirit of adventure. This is an adjustable single aircell BC with a new ergonomic design that provides more than just lightweight comfort. It offers rotating buckles on the shoulder pads, to make it easier to don and help it fit the body better. It's also ideal for the female body. GO is made of light and resistant nylon 210 denier fabric, protected on the surface by a polyurethane layer and radio frequency soldered for maximum wear resistance.



The newly designed aircell provides high buoyancy without affecting comfort. Round profile pockets allow easy access at all times. The pockets are large and strong, made of nylon fabric reinforced by a strong mesh material sections which also allows water to drain quickly. The new air-net ergonomic backpack is lightweight and soft. This backpack has no rigid elements and can be easily folded and stored in your travel bag.

The new Quick Dry Coated Mesh band helps reduce weight and dries quickly after diving.

The tank attachment is provided by the classic main band with a plastic buckle with an added upper band. This ensures that the tank is astonishingly well balanced in all position and it doesn't put any added pressure on your back.

Go is incredibly lightweight (2.6kg in L size) and doesn't take much room in your bag once folded up allowing easy storage.

Go comes in a small lightweight dedicated 'travel' bag for added protection.

It couldn't be easier to pack in your travel baggage.

The shoulder pads also feature Lightweight Aluminum D-rings. Their pre-bent shape and generous size make even heavy accessories easy to attach and access. Side grommets are provided to attach a SCUBAPRO knife.

Each removable pocket can be loaded with up to 10 lb (4.5 Kg) of SCUBAPRO Ecoweight above the size "M" and up to 5.5 lb (2.5 Kg) in the "S" and "XS" sizes (see assy procedure, fig. 4-1, 4-2).

A separate kit for trim weight is available and each of the two pockets can carry up to 2.2lb (1kg) of Ecoweight.

Sizes	Max Lifting Buoyancy (N*)	Max Lifting Buoyancy (lb)	Max size of bottle (l)
XS	100	22.5	15
S	120	27.0	
M	140	31.5	
L	160	36.0	18
XL	190	42.7	

*N=Newton

17. MASTER JACKET

(Certified under CBRD - EN 12628, which means that the Master Jacket allows the diver to maintain a safe, upright position on the surface, with their head above water, even in the event they should lose consciousness).

The original design of this legendary model was developed in 1978: it was the first diving Jacket ever produced and its design and technology is so successful that as of today, it is practically unchanged from the original. The Master Jacket is quite different from all other models on the market due to its "three dimensional balance" buoyancy control, regardless of the sequence of movements or in what position the movement begins underwater, the internal air bubble cannot cause rotational movements, which would destabilize the diver (fig. A).



This outcome is owed to the peculiar internal bag design, that uses three interconnecting circles or passageways, permitting the air bubble an unobstructed circulation (fig. A1). If the ring is interrupted (fig. B), a rotation of the ring itself, which would bring one of the ends (E or E1) to the highest point (where the bubble (O) resides), would cause the rotation to stop. If the ring is not interrupted, however, the rotation can continue until it reaches the most stable configuration. This guarantees not only an unparalleled level of comfort during diving, but also a "face-up" position of the diver on the surface, even in case of unconsciousness, providing thus an inherent level of safety. For these reasons, the Master Jacket is the only BCD in the world to be type-approved as a CBRD (Combined Buoyancy Rescue Device) (EU Norm): this means that it can be used as a normal buoyancy compensator vest, but it is also able to guarantee that while on the surface the diver will always remain in a safe, upright position with their head above water, even in the event they should lose consciousness. Additional solutions, both technical and in the types of material, have been implemented to increase the already excellent level of safety. For example, the Master Jacket consists of two bags: the internal, waterproof bag, holds the 'bubble of air'; it is made of polyurethane/polyether and is radiofrequency welded. The external bag is made of high-performance fabric (Cordura 1000) sewn with thick thread in the same material to ensure mechanical durability and resistance to abrasion.

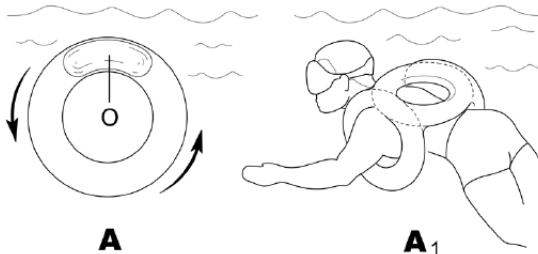

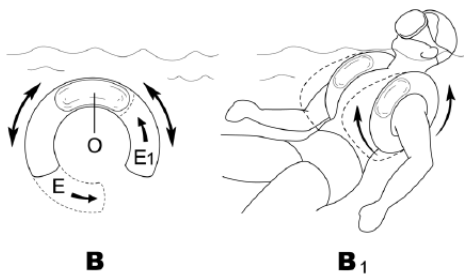

The webbing system is conceived for the maximum safety too: in fact there are adjustable shoulder belts with 50 mm. (2") metal buckles, easy to adjust even with thick gloves, to hold tight the diver, even jumping into the water from many meters! The chest straps are elastic to prevent squeezing of the lungs, if the bag is over inflated. High visibility fabric and reflective patches complete the safety features.

In the right epaulette there is an elastic loop (fig. L), to hold a blinking light during the night dive (such as SCUBAPRO Safety Light or Strobe Light).

Back pack, back plate, Supercinch Q.A., all valves and inflator, are described in the manual. An additional safety feature offered in the Master Jacket is the use of an emergency air canister (fig. PB), which can be stowed in special pockets to protect against snags. Heavy duty AISI 316 stainless steel "D" rings allow to hook up heavy accessories.

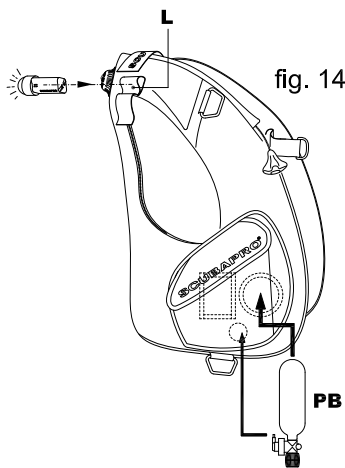

The latest evolution of the Master Jacket includes the new generation valves and Scubapro command unit, as well as a soft Ainet® back panel.

Performance is listed below and printed in the interior patch stitched on the BC.

Sizes	Max Lifting Buoyancy (N*)	Max Lifting Buoyancy (lb)	Max size of bottle (l)	
S	220	49.5	10+10	
M	230	51.7		
L	240	54.0		
XL	280	62.9		
XXL	310	69.7		

*N=Newton

18. SEAHAWK LITEHAWK

These are back floatation BCs which consist of a single bag WING, an independent harness and an adjustable cummerbund system.

The system is modular, making it possible to apply the optional weight pockets both on the back and on the cummerbund, by using the integrated weight system pockets.

Our Hawk jackets leave the diver's chest and arms free, so it is ideal for any kind of underwater work and offers more freedom of movement.

In addition, when the bag is empty or slightly inflated, there is less drag because it is kept slim and maintains a low profile by the elastic bands. SEAHAWK provided with pockets and an unisex shoulder design.



LITEHAWK is the lightest version possible being just a light harness with a bladder.

The principal characteristics of these models are:

- Holding system for the rear bag with additional elastic bands that make it possible to keep it basically covered by the diver's own shape when deflated, reducing hydrodynamic drag to the lowest conceivable levels.
- The elastic system on the cummerbund allows for perfect adherence and fit at all depths and under any conditions.
- Soft edges on the neck improve diver comfort.
- Rear pockets with integrated counterweights.
- Integrated weight system (optional)
- A single adjustment for the straps makes it even easier to put the BC on quickly and correctly, decreasing the number of dangling straps and making it easier to wear.



The bag is made of Nylon 420 and Cordura® 1000 coated with polyurethane and the harness is made of a polyester fabric with soft inner padding.

Each pocket can be loaded with up to 12 lb (5.5 Kg) of SCUBAPRO Ecoweight in all sizes for SEAHAWK.

Each back pocket of LITEHAWK and SEAHAWK can be loaded with up to 5 lb. (2.25 Kg) of SCUBAPRO Ecoweight.

All valves and tank band assembly are described in the Manual. Performance (printed in the patches stitched besides the back pack) are listed below:

SEAHAWK:

Performance is listed below and printed in the interior patch stitched on the BC.

Sizes	Max Lifting Buoyancy (N*)	Max Lifting Buoyancy (lb)	Max size of bottle (l)	
XXS	170	38.2	15	
XS	170	38.2		
S	190	43.0	18	
M	190	43.0		
L	190	43.0		
XL	190	43.0		
XXL	190	43.0		

*N=Newton

LITEHAWK:

Performance is listed below and printed in the interior patch stitched on the BC.

Sizes	Max Lifting Buoyancy (N*)	Max Lifting Buoyancy (lb)	Max size of bottle (l)	
XS/S	130	29.2	15	
M/L	130	29.2		
XL/XXL	130	29.2		

*N=Newton

19. CLASSIC - CLASSIC UNLIMITED - CLASSIC EXPLORER

The stabilizing jacket was invented by SCUBAPRO. It features the most complete buoyancy control system ever.

Stabilizing jackets utilize unrestricted internal passageways allowing air to flow continuously throughout the jacket accumulating at the highest point. The diver is surrounded by that bubble and moves easily and precisely. At the surface stabilizing jackets provide a very comfortable and relaxed floating position which allows complete safety in a 'face up' position.

These models are the culmination of years of SCUBAPRO experience on BC design and production. The original design of the legendary model has been developed since 1978: it was the first diving Jacket ever produced and the results were so good that up until today, it is practically, unchanged. We now have 2 different versions of the stabilizing jacket to meet all diver needs.

The Classic Unlimited is a high end BC targeting demanding divers who desire a BC which is as complete as possible.

Classic Explorer is dedicated to diving centers and to individual divers who prefer a simple yet quality BC, however without.

Compromising on safety and comfort.



Both versions feature:

1. High durability double coated 420-denier nylon fabric.
2. Basic air cell with reinforced heavy polyester fabric and threads.
3. 3 dump valve deflation system enabling the diver to dump air in any underwater position.
4. Standard belt with stainless steel cam buckle allows easy and secure closure of the BCD.
5. Pre-bent stainless steel D-rings allow all accessory attachments.
6. Two large volume pockets equipped with double sliders offer convenient access to accessories and secure storage no matter you are left or right hand.
7. Knife attachment system is situated on both sides.
8. Super cinch tank band is provided as standard.

Back packs, back plate, soft padding and Supercinch Q.A. are the ones described in the Manual.



Classic Unlimited also features:

1. Integrated quick release weight system.
2. Two rear trim pockets which counterbalance front weights and provide a well-balanced swimming position.
3. Soft neoprene neck roll and thermoformed foam-padded back pad provide exceptional dive comfort in and out of the water.
4. Flexible cummerbund with stainless steel cam buckle.

Each pocket can be loaded with up to 12 lb (5.5 Kg) of SCUBAPRO Ecoweight above the size "L" and up to 10 lb (4.5 Kg) in the sizes below (see assembly procedure, fig. 4-1, 4-2), and each back pocket can be loaded up to 5lb (2.25 Kg).



Performance is listed below and printed in the interior patch stitched on the BC.

CLASSIC EXPLORER / CLASSIC UNLIMITED:

Sizes	Max Lifting Buoyancy (N*)	Max Lifting Buoyancy (lb)	Max size of bottle (l)	
XS	140	31.5	18	
S	140	31.5		
M	210	47.2		
L	280	62.9	10+10	
XL	310	69.7		

*N=Newton

CLASSIC:

Sizes	Max Lifting Buoyancy (N*)	Max Lifting Buoyancy (lb)	Max size of bottle (l)	
XS	150	33.7	18	
S	180	40.5		
M	200	45.0		
L	260	58.5	10+10	
XL	360	80.9		

*N=Newton

20. LEVEL

Level is a front-adjustable BC summing up all the best features you can possibly need in a recreational dive. It's lightweight, based on a bladder made out of EndurTex high tenacity nylon fabric, extremely light and robust. It's extremely comfortable fit, with a bladder designed to gently wrap around the body under any inflation conditions. It's perfectly stable thanks to its full sized backpack holding the tank.

Level is equipped with the latest upper airway and fittings showing great reliability and performance. It also features flat-buckled quick-release integrated weight system that offers more comfort and convenience. The big hook and loop lid pockets on the front together with D-rings offer great cargo capacity. Two octopus pockets are located on the front to easily store and release octopus and console LP hose. Side stainless steel grommets are standard on the left side for SCUBAPRO knife attachment. Each pocket can be loaded with up to 11 lb (5 Kg) of SCUBAPRO Ecoweight (see assy procedure, fig. 4-1, 4-2).



A separate kit for trim weight is available and each of the two pockets can carry up to 2.2lb (1kg) of Ecoweight. The kit is to be installed by an authorized Scubapro dealer.

Performance is listed below and printed in the interior patch stitched on the BC.

Sizes	Max Lifting Buoyancy (N*)	Max Lifting Buoyancy (lb)	Max size of bottle (l)
XS	100	22.5	10
S	120	27.0	15 
M	130	29.2	
L	150	33.7	
XL	170	38.2	

*N=Newton

21. BELLA

SCUBAPRO is pleased to introduce the brand new Bella buoyancy compensator, specifically designed and meticulously tailored for female divers. It is based on the same Y shaped shoulder concept as the new Glide BC. Here the layout is specifically optimized for fitting female body, keeping pressure out of uncomfortable spots and always providing safe and reliable stability. BC harness holds tight on the diver body leaving the best freedom on arms movements. The triangular ring on the shoulder split the force in three directions balancing the pressure all over the body and keeping the harness always under control under any diving conditions. The lower strap is connected to the backpack where it meets the cummerbund in a safe and comfortable link. Bella BC has been specifically designed for female divers featuring contoured hip indents. Wrap-around air bladder retains a cradle-like shape to "hug" the female ladies diver throughout the full range of inflation, thereby ensuring optimum comfort and total control in all diving environments. Soft material in shoulder area result in substantially enhanced topside comfort when gearing up for dives.



The SCUBAPRO exclusive wraparound air bladder, which retains its cradle-like shape even when fully inflated, and the quick-release adjustable shoulder buckles make this BC very easy to put on, to take off and easy to use. A variety of styles and sizes offer a custom-like fit.

The 5-point deflation system with 3 dump valves enables you to dump air from a variety of underwater positions. Proprietary quick-release integrated weight system offers more comfort and convenience. Two rear trim pockets counterbalance the front weight and provide a well-balanced swimming position. Soft neoprene neck and padded backpack for optimum comfort. Fully-adjustable cummerbund to ensure proper fit. Zippered cargo pockets complete the finishing detail as convenient accessory D-rings.

Each pocket can be loaded with up to 10 lb (4.5 Kg) of SCUBAPRO Ecoweight (see assembly procedure, fig. 4-1, 4-2), and each back pocket can be loaded up to 5lb (2.25 Kg).

Back packs, back plate, soft padding, cummerbund system and Supercinch Q.A. are the ones described in the Manual.

Performance is listed below and printed in the interior patch stitched on the BC.

Sizes	Max Lifting Buoyancy (N*)	Max Lifting Buoyancy (lb)	Max size of bottle (l)
XS	100	22.5	10
S	130	29.2	15 
M	140	31.5	
L	140	31.5	
XL	150	33.7	

*N=Newton

22. GLIDE

Glide is the new front adjustable BC by SCUBAPRO including the best features to make it comfortable and to perfectly fit any diver needs. The new Glide is equipped with Y shaped shoulders that hold the BC tight on the diver body leaving the best freedom on arms movements. The triangular ring on the shoulder split the force in three directions balancing the pressure all over the body and keeping the harness always under control under any diving conditions. The lower strap is connected to the backpack where it meets the cummerbund in a safe and comfortable link.

The dump system includes 3 new generation dump valves that allows the diver to deflate the bladder in any position. The aircell, fully made of Nylon 420 coated with polyurethane, is specifically designed to wrap around the body of the diver.

The zippered pockets are easily accessible, they are wide enough to store slates, a spare light or a marker buoy in them. Glide is also equipped with stainless steel D-rings for easy accessories attachment. Proprietary quick-release integrated weight pocket system with flat buckles shows easy handling and safety. Each pocket can be loaded with up to 10 lb (4.5 Kg) of SCUBAPRO Ecoweight (see assy procedure, fig. 4-1, 4-2). Two rear trim pockets counterbalance the front weight and provide a well-balanced swimming position.

Glide bottle attachment system is based on Supercinch Q.A. with quick release (described in the manual). It includes a full stainless steel buckle which make it super strong and reliable.

Performance is listed below and printed in the interior patch stitched on the BC.

Sizes	Max Lifting Buoyancy (N*)	Max Lifting Buoyancy (lb)	Max size of bottle (l)
XS	100	22.5	10 15 
S	130	29.2	
M	140	31.5	
L	140	31.5	
XL	150	33.7	
XXL	170	38.2	

*N=Newton



23. HYDROS PRO

A technological breakthrough in BC design and construction, HYDROS PRO is a Premium Plus back-inflation BC designed for Professional and serious Recreational Divers. Its ground-breaking design also makes it travel-friendly without compromising quality, durability or performance.

HYDROS PRO features an exclusive Fluid-Form 3D Injection Moulded Monprene® Gel Harness System. Fluid-Form replaces the traditional Cut, Make and Trim (CMT) method of manufacturing BC's by replacing stitched fabric with soft, resilient Thermoplastic Elastomer Harness components and then assembling them in a modular, mechanical process.

The BC's Monprene® construction offers durability and is resistant to UV and abrasion. The 3D Gel material conforms to the shape of the body for extreme comfort and features a Body Grip Gel to prevent the BC from shifting and riding up. Instant Dry properties make it ideal for travel due to less water retention and lower post-dive weight



HYDROS PRO uses a Modular design. This customisable approach allows the diver to add or subtract weight systems, crotch straps and accessory pockets. HYDROS PRO is supplied with two different Waist Strap systems that enable the diver to configure the BC depending on the type of diving. System 1 is a full weight integrated system that uses SCUBAPRO'S proprietary Buckle Weight System. System 2 is a minimalist Trav-Tek waist strap.

- **Harness Features:**

HYDROS PRO features a highly adjustable, alpine-style harness. The BC is equipped with adjustable quick-release buckles at the waist, shoulder and chest (sternum). A dual-compound backplate with Torso-Flex Zone and Articulated Shoulder Straps auto-adjusts to the diver's torso length or shape to provide excellent comfort and freedom of movement. The rigid plate only requires a single tank strap and features five X-Grips for extra tank security and stability. the shoulder straps open for easy donning due to the unique design and allows the BC to pack up small for travel.

- **iQ Air Cell Features:**

Air distribution is controlled with a 2-Stage Inflation Tri-Bungee System. The system allows for a more streamlined and compact air-cell underwater and an even air distribution and higher lift capacity at the surface. The full-donut Cross Flow design creates unrestricted internal Air-Flow to help reduce air trapping, aid manoeuvrability and allow for easy deflation. The robust Dorsal Weight-Wing protects the Air-cell against abrasion and accommodates 2 x 2kg Outboard-mounted Trim Weight Pockets to assist with surface position.

- **System Features:**

Using a Smart-Pack design, the HYDROS PRO is compact for easy transport and storage with its folding shoulder & waist straps that pack into the wing. The BC features various Multi-Mount accessories that can be easily mounted on specifically arranged connections. The Quick Switch System allows the diver to configure the BC from a minimalist Trav-Tek System to a Buckle Weight System, or vice versa. The Buckle Weight System uses a fixed position buckle for easy one-handed operation and accommodates 2 x 4kg weight pockets.

Sizes	Max Lifting Buoyancy (N*)	Max Lifting Buoyancy (lb)	Max size of bottle (l)
MEN SMALL	150	35	18
MEN MEDIUM	170	40	18
MEN LARGE	170	40	18
MEN XL-XXL	170	40	18
WOMEN XS-S	150	35	18
WOMEN MEDIUM	150	35	18
WOMEN LARGE	170	40	18

*N=Newton

24. HYDROS X

Hydros X is the world's first front adjustable compensator device offering a fully injection molded thermo-plastic rubber harness. This unique feature allows to tailor the harness shape perfectly fitting the diver's torso and offering a superior comfort and stability. Every component is detachable and easily replaceable in the event of damage or for customization with colored parts. The thermo-plastic rubber doesn't absorb water minimizing drying time. Aircell and harness are modular and detachable. The bladder made out of EndurTex high tenacity nylon fabric is extremely light and robust offering a generous lift. It's perfectly stable thanks to its full sized backpack holding the tank in place with a stainless steel Super Cinch buckle.

Hydros X is equipped with the latest upper airway and fittings showing great reliability and performance. It also features flat-buckled quick-release integrated weight system that offers more comfort and convenience. Each pocket can be loaded with up to 9 lb (4 Kg) of SCUBAPRO Ecoweight (see assy procedure, fig. 4-1, 4-2). Trim weight pockets on the back of the bladder can be loaded with up to 4.4lb (2kg) of SCUBAPRO Ecoweight.

The big zippered cargo pockets offer great capacity and remain accessible even with fully loaded weight pockets, the two stainless steel D-Rings at the bottom give additional hanging points. This BC features a Multi-Mount Accessory Matrix with multiple D-Ring and mounting points that easily attach various dive accessories.



Sizes		Max Lifting Buoyancy (N*)	Max Lifting Buoyancy (lb)	Max size of bottle (l)
MEN	S	120	27.0	15
	M	160	36.0	18
	L	190	42.7	
	XL-XXL			
WOMEN	XS-S	120	27.0	15
	M	160	36.0	18
	L			

*N=Newton

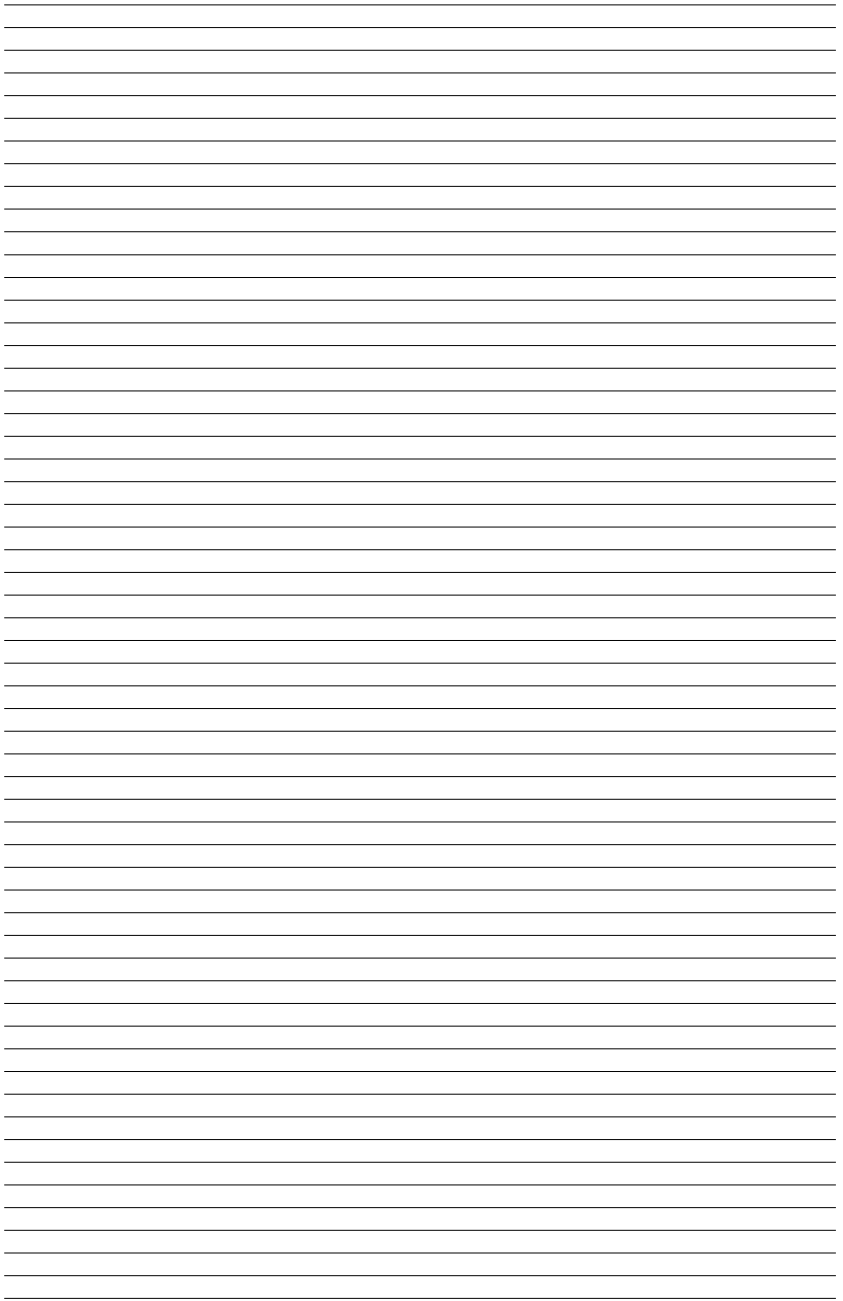

A large area of the page is filled with horizontal lines, providing space for writing or drawing.



SCUBAPRO



SCUBAPRO
cares



REDUCING OUR FOOTPRINT.
Product packaging is made of
recycled materials & is recyclable.



BUILT TO LAST.
Longer lasting products
mean less waste.

Manual and Declarations of Conformity on:
Benutzerhandbuch und Konformitätserklärung auf:
Manuel et déclarations de conformité sur :
Manuale e Dichiarazioni di Conformità su:
Manual y declaraciones de conformidad en:
Handleiding en Conformiteitsverklaringen op:
O Manual e as Declarações de Conformidade estão disponíveis em:
Руководство и Декларация Соответствия:
Kézikönyv és megfelelőségi nyilatkozatok itt:
Instrukcja i deklaracja zgodności z przepisami znajduje się:
Příručku a Prohlášení o shodě naleznete na stránkách:
Priručnik i izjave o sukladnosti na:
Bruksanvisning och Försäkran om överensstämmelse finns på:
Manual și Declarații de Conformitate pe:
手冊及符合性声明：
マニュアルおよび適合宣言書はこちら：

scubapro.com



MANUAL



DECLARATIONS
OF CONFORMITY



Johnson Outdoors Diving