



**Aladin Sport  
(Matrix)  
User Manual**



**deep down you want the best**

[scubapro.com](http://scubapro.com)

## ALADIN SPORT DIVING COMPUTER - DESIGNED BY DIVING ENGINEERS

Welcome to SCUBAPRO dive computers and thank you for purchasing the Aladin Sport. You are now the owner of an extraordinary partner for your dives. This manual provides you with easy access to SCUBAPRO state-of-the-art technology and key Aladin Sport features and functions. Should you wish to know more about SCUBAPRO diving equipment, please visit our website at [www.scubapro.com](http://www.scubapro.com).



### IMPORTANT

Please carefully read and understand the **Read First** booklet that is included in the package before using your SCUBAPRO Aladin Sport.

### WARNING

- The Aladin Sport has a depth rating of 120m/394ft.
- If 120m/394ft is exceeded, “---“ will appear in the depth field and the decompression algorithm will not calculate correctly.
- Diving at oxygen partial pressures higher than 1.6bar (corresponding to a depth of 67m/220ft when breathing compressed air) is extremely dangerous and could lead to serious injury or death.

### WARNING

- The Aladin Sport is delivered in deep sleep mode with the display off. You must activate the Aladin Sport by pressing and holding the left or right button before the first dive. The Aladin Sport will not start the dive mode or may show the wrong depth value if activation is not done before immersion.



Hereby, Uwatec AG declares that the radio equipment type PAN1740 is in compliance with Directive 2014/53/EU.

The full text of the EU declaration of conformity is available at [www.scubapro.com/declarations-conformity](http://www.scubapro.com/declarations-conformity).

#### **Standard EN 13319: 2000**

The Aladin Sport dive instrument is also compliant with the European standard EN 13319: 2000 (EN 13319: 2000 – Depth gauges and combined depth and time measuring devices – Functional and safety requirements, tests methods).

# TABLE OF CONTENTS

<b>1. INTRODUCTION</b>	<b>6</b>
1.1 Safety considerations	6
1.2 Quick reference of the display layout	6
<b>2. SYSTEM AND OPERATION</b>	<b>7</b>
2.1 System description	7
2.2 Operation	7
2.2.1 Push buttons	8
2.2.2 Water contacts	8
2.2.3 Switching on the display	9
2.2.4 How to navigate the Aladin Sport at the surface	9
2.2.5 Checking the desaturation time	9
2.2.6 Checking the surface interval	10
2.2.7 Checking the battery condition	10
2.2.8 Active backlight	12
2.2.9 Switching off the display	12
2.2.10 Alarm clock	12
2.3 SOS mode	13
<b>3. DIVING WITH YOUR ALADIN SPORT</b>	<b>13</b>
3.1 Terminology/Symbols	13
3.1.1 General terminology/Display during no-stop phase	13
3.1.2 Display during decompression phase	14
3.1.3 Nitrox information (O <sub>2</sub> information)	14
3.2 Attention messages and alarms	15
3.2.1 Attention messages	15
3.2.2 Alarms	15
3.3 Preparation for the dive	15
3.3.1 Function check	15
3.3.2 Setting the gas mixture and ppO <sub>2</sub> max	16
3.3.3 Preparation for diving with 2 or 3 gas mixtures	16
3.3.4 Setting the MB level	16
3.4 Functions during the dive	16
3.4.1 Alternate displays	16
3.4.2 Setting bookmarks	17
3.4.3 Dive time	17
3.4.4 Current depth/O <sub>2</sub> % mix	17
3.4.5 Max depth/Temperature	17
3.4.6 Set max depth reached	18
3.4.7 Ascent rate	18
3.4.8 Partial pressure of oxygen (ppO <sub>2</sub> max)/Maximum operating depth (MOD)	19
3.4.9 Oxygen toxicity (CNS O <sub>2</sub> %)	19
3.4.10 Decompression information	20
3.4.11 Decompression values	20
3.4.12 Total ascent time	21
3.4.13 Safety stop timer	21
3.5 Functions after the dive	22
3.5.1 End of a dive	22
3.5.2 Desaturation time, No-fly time and No-dive warning	22
3.6 Diving in mountain lakes	23

3.6.1	Altimeter .....	23
3.6.2	Altitude classes .....	23
3.6.3	Prohibited altitude .....	24
3.6.4	Decompression dives in mountain lakes .....	24
3.7	Gauge mode .....	24
3.7.1	Switching the gauge mode on and off .....	24
3.7.2	Diving in gauge mode .....	25
3.7.3	After diving in gauge mode .....	25
3.8	Apnea mode .....	25
3.8.1	Switching the apnea mode on and off .....	25
3.8.2	Diving in apnea mode .....	26
3.9	Diving with microbubble (MB) levels .....	27
3.9.1	Comparison of dives with MB level L0 and MB level L5 .....	27
3.9.2	Terminology .....	27
3.9.3	Preparation for a dive with MB levels .....	29
3.9.4	Functions during the dive with MB levels .....	29
3.9.5	Completing a dive with MB levels .....	31
3.10	PDIS (Profile Dependent Intermediate Stop) .....	31
3.10.1	Introduction to PDIS .....	31
3.10.2	How does PDIS work? .....	32
3.10.3	Special considerations when diving with more than one gas mixture (Aladin Sport) .....	33
3.10.4	Diving with PDIS .....	33
3.11	Diving with 2 or 3 gas mixtures .....	34
<b>4.</b>	<b>Functions on the surface .....</b>	<b>37</b>
4.1	COMPASS .....	37
4.1.1	Finding a direction .....	37
4.1.2	Setting declination .....	38
4.1.3	Setting timeout .....	38
4.1.4	Recalibrating the compass .....	38
4.2	DIVE PLANNER .....	40
4.2.1	Planning a no-stop dive .....	40
4.2.2	Planning a decompression dive .....	41
4.2.3	Leaving the dive planner .....	41
4.3	LOGBOOK .....	42
4.3.1	Survey .....	42
4.3.2	Operation .....	42
4.3.2.1	Page 1 .....	43
4.3.2.2	Page 2 .....	43
4.3.2.3	Page 3 .....	43
4.3.2.4	Statistical information (HISTORY) .....	44
<b>5.</b>	<b>SETTINGS .....</b>	<b>44</b>
5.1	Altitude adjustment .....	44
5.2	Dive menu .....	45
5.2.1	Gas menu .....	46
5.2.2	Scuba menu .....	47
5.2.3	User menu .....	49
5.3	Watch menu .....	50
5.3.1	Setting the alarm clock time .....	51
5.3.2	Setting the UTC offset (coordinated universal time) .....	51
5.3.3	Adjusting the time of day .....	51
5.3.4	Selecting 24-hour or AM/PM setting .....	52
5.3.5	Adjusting the date .....	52

5.3.6	Switching the sound on and off .....	53
5.3.7	Check the battery status .....	53
5.4	Apnea menu .....	54
5.4.1	Setting the total session depth .....	54
5.4.2	Setting the surface interval factor (SIF) .....	55
5.4.3	Setting the dual depth alarm .....	55
5.4.4	Setting the incremental depth alarm .....	55
5.4.5	Setting the dive time interval alarm .....	55
5.4.6	Setting the surface interval alarm .....	56
5.4.7	Setting the ascent speed alarm .....	56
<b>6.</b>	<b>INTERFACING WITH WINDOWS/MAC AND APPS .....</b>	<b>56</b>
6.1	Introduction to SCUBAPRO LogTRAK .....	56
6.2	Changing warnings/settings of the Aladin Sport and reading computer information .....	58
<b>7.</b>	<b>TAKING CARE OF YOUR ALADIN SPORT .....</b>	<b>58</b>
7.1	Technical information .....	58
7.2	Maintenance .....	58
7.2.1	Replacing the battery .....	59
<b>8.</b>	<b>COMPLIANCE .....</b>	<b>60</b>
8.1	EU Radio directive .....	60
8.2	Diving .....	60
8.3	FCC & ISED regulatory notices .....	60
8.3.1	Modification Statement .....	60
8.3.2	Interference Statement .....	60
8.3.3	Wireless Notice .....	61
8.3.4	FCC Class B Digital Device Notice .....	61
8.3.5	CAN ICES-3 (B) / NMB-3 (B) .....	61
8.4	Manufacturer .....	61
<b>9.</b>	<b>APPENDIX .....</b>	<b>61</b>
9.1	Warranty .....	61
9.2	Glossary .....	62

# 1. INTRODUCTION

Your Aladin Sport User Manual is divided into the following main chapters.

1. Introduction
2. System and operation
3. Diving with your Aladin Sport
4. Functions on the surface
5. Settings
6. Interfacing with Windows/Mac and Apps
7. Taking care of your Aladin Sport
8. Compliance
9. Appendix (Warranty, Glossary).

## 1.1 Safety considerations

Dive computers provide divers with data; however, they do not provide the knowledge of how this data should be understood and applied. Dive computers cannot replace common sense! You must therefore carefully read and understand this entire manual before using your Aladin Sport.

## 1.2 Quick reference of the display layout

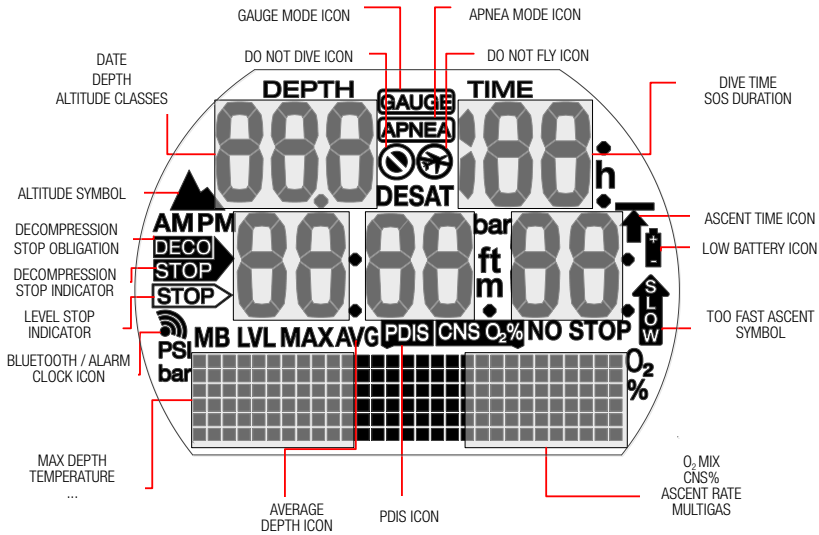

## 2. SYSTEM AND OPERATION

### 2.1 System description

The Aladin Sport displays all important dive and decompression data and has a memory which stores the full dive data. This data can be transmitted with a Bluetooth interface and LogTRAK software to Windows or Mac personal computers, Android devices or Apple devices.

A LogTRAK software CD is included with the Aladin Sport package. LogTRAK software is also available at the SCUBAPRO website as well as the Android Play Store and iPhone App Store.

 **NOTE:** The Aladin Sport enables you to use up to 3 different gas mixtures during the same dive. However, for purposes of simplicity, the operating instructions in this manual refer primarily to dives with a single gas mixture. Instructions for diving with more than 1 gas mixture have been summarized in special chapters.

### 2.2 Operation

Operating schematic

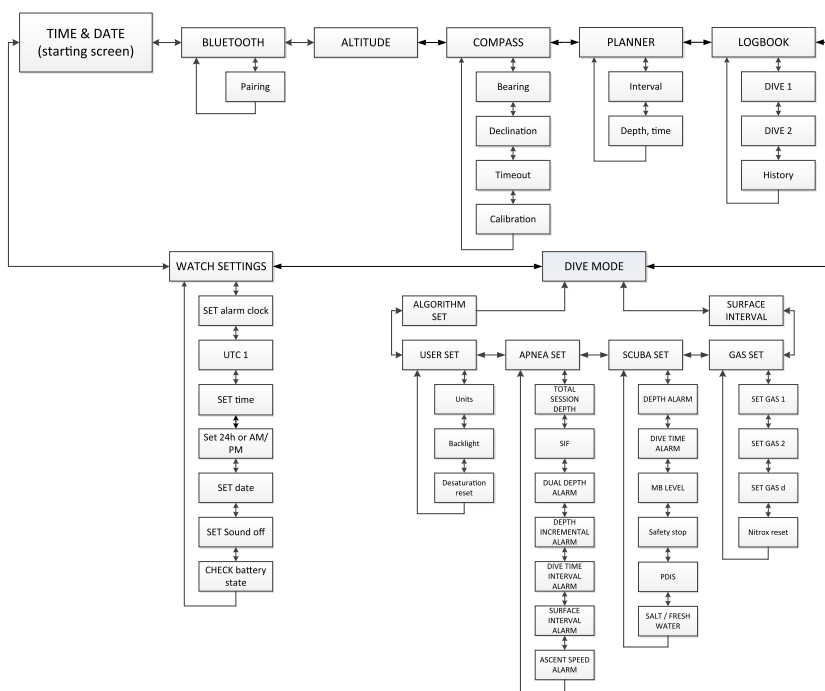

## 2.2.1 Push buttons

The Aladin Sport's features are accessed and controlled with 2 push buttons. Operation of these push buttons is divided into 2 methods: "press" and "press-and-hold" (for 1 second) – also referred to as a "long" press on the menu diagrams. Each method allows you to access different computer functions.



### At the surface:

**PRESS-AND-HOLD LEFT OR RIGHT BUTTON:**

- Switches on the Aladin Sport (time of day display).

**PRESS-AND-HOLD RIGHT BUTTON:**

- Functions like the ENTER/RETURN key on a keyboard.
- Provides access to the displayed sub menu.
- Opens the displayed setting.
- Confirms the displayed value or setting selection.

**PRESS LEFT OR RIGHT BUTTON:**

- Allows scrolling through menus.
- Once entered into a sub menu or series of settings:
- Increases (press right button) or decreases (press left button) the indicated value or setting.

**PRESS-AND-HOLD LEFT BUTTON:**

- Activates the backlight in time of day display.
- Escape the current function or menu to last level or setting.

**PRESS-AND-HOLD BOTH BUTTONS:**

- Exits the current function or menu and switches to the time of day display.
- From the time of day display, switches off the Aladin Sport.

### SCUBA mode:

**PRESS RIGHT BUTTON:**

- Accesses alternate displays.

**PRESS-AND-HOLD LEFT BUTTON:**

- Operates the backlight.

**PRESS LEFT BUTTON:**

- Activates the safety stop timer (dive mode only, in depths < 5m/15ft).
- Sets bookmark.

### APNEA mode:

**PRESS-AND-HOLD RIGHT BUTTON:**

- Starts dive manually.

### GAUGE mode:

**PRESS LEFT BUTTON**

- Restarts stopwatch.

### Diving with 2 or 3 mixtures:

**PRESS-AND-HOLD RIGHT BUTTON:**

- Initiates switch to gas d, gas 1 or gas 2.
- Changes selected gas (press left or right button).
- Confirms switch to gas d, gas 1 or gas 2.

## 2.2.2 Water contacts

Upon submerging, the water contacts activate the Aladin Sport automatically.



### 2.2.3 Switching on the display

All segments on:

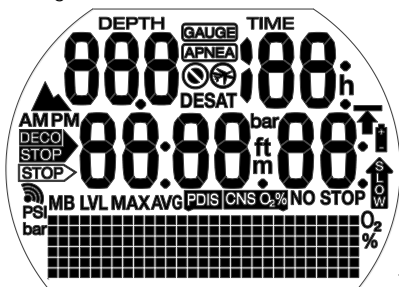

Start up display with time:

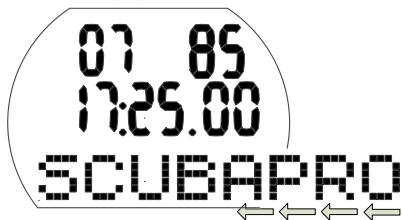

NOTE: On the lower matrix row on the display, longer words are scrolled. In this manual, such scrolling is indicated by left-pointing arrows running along the bottom of the display.

Time of day display:



The Aladin Sport switches on:

- Automatically, upon submerging in water or when triggered by a change in atmospheric pressure.
- Manually, by pushing and holding either the left or right button.

If switched on with the left button, all display segments appear for 5 seconds. Afterwards, the display shows the time of day, the date and a scrolling SCUBAPRO

which is quickly replaced by the day of the week. This is referred to as the “time of day” display.

In the time of day display, if there is remaining saturation from the last dive or from a change of altitude, the Aladin Sport may indicate the “Do not fly” icon, “Do not dive” icon or “Altitude” icon or a combination of the icons depending on the situation.

NOTE: Most navigation descriptions in this manual start from the time of day display. At the surface, the Aladin Sport returns automatically to this display.

NOTE: When the Aladin Sport is in a state of rest, no information is displayed but the atmospheric pressure continues to be monitored. If a change in altitude classes is detected, the Aladin Sport automatically switches on for 3 minutes.

NOTE: Without active use the Aladin Sport’s display automatically reverts to the time of day display, and after 3 minutes the computer switches off.

### 2.2.4 How to navigate the Aladin Sport at the surface

Starting from the time of day display you can enter into different menus.

### 2.2.5 Checking the desaturation time

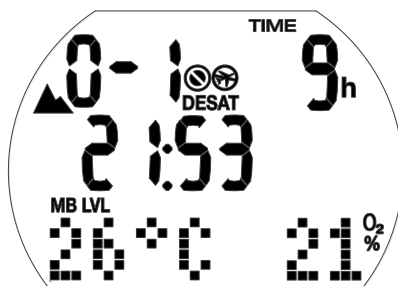

From the time of day display you can check the desaturation time\* with a press-and-hold of the right button. Desaturation time is determined either by oxygen toxicity, nitrogen saturation or the regression

of microbubbles, depending on which requires the longer time.

\*Desat time is displayed only if there is remaining saturation due to the last dive or a change of altitude.

### **⚠ WARNING**

For calculations of desaturation and no-fly time it is assumed that you are breathing air while on the surface.

#### **2.2.6 Checking the surface interval**

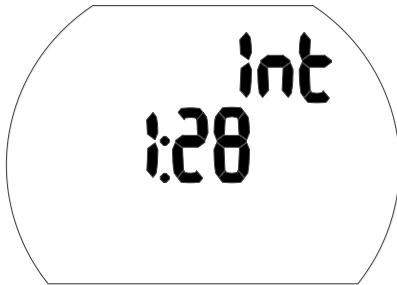

From the time of day display you can check the surface interval with a press-and-hold of the right button (taking you directly to the dive menu) and then another press-and-hold (taking you to surface interval).

Surface interval is the elapsed time since the end of your last dive; it is displayed as long as there is remaining saturation.

#### **2.2.7 Checking the battery condition**

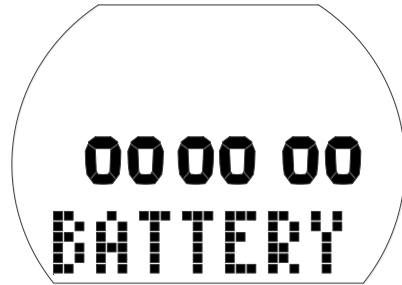

From the time of day display you can check the battery condition by pressing the left or right button to scroll to the watch menu. With a press-and-hold of the right button you enter watch settings, then press the right button 6x to scroll to the battery status screen.

The battery status screen shows how much energy is left in the CR2450 battery. A fresh battery is indicated by 6 zeros.

While the Aladin Sport periodically monitors battery status, you can manually trigger a status check with a press-and-hold of the right button while in this screen.

The Aladin Sport's intelligent battery algorithm will limit some functions as you near the end of the battery's life. See the table below for battery status and corresponding function limitations.

Indicator in battery status display	At other displays	Battery status	Function limitations
000000		Fresh battery	none
_00000		Battery ok for diving	none
__0000		Battery ok for diving	none
___000	Battery symbol	Weak battery, change to fresh	<b>Backlight not operating</b>
____00	Blinking battery symbol, no dive symbol	Completely used battery, change to fresh	<b>Buzzer and backlight not operating, diving not recommended</b>
_____0	Blinking battery symbol, no dive symbol	Completely used battery, change to fresh, Aladin Sport may make a reset any time and remain off	<b>Diving mode not allowed, only watch is active. Settings cannot be changed (OFF)</b>

☞ **NOTE:** Battery capacity and voltage at the end of a battery's lifetime may vary between battery manufacturers. Generally, operation at low temperatures decreases battery capacity. Therefore, when the battery indicator drops below 4 zeros, change the battery to a fresh one before making any new dives.

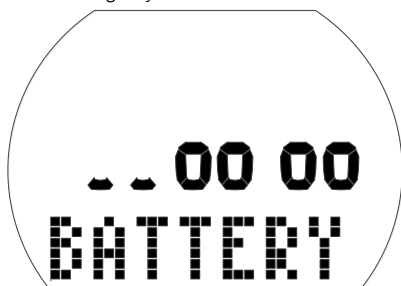

### ⚠ WARNING

When the battery is critically low, the watch settings are disabled (the watch set menu is "OFF").



### ⚠ WARNING

- If the battery status graph shows only 2 zeros, the battery symbol will blink, both on the surface and in dive mode, to alert you of a dangerous situation. At this point the battery may not have enough energy to finish a dive. In such a case, audible alarms and attention messages are disabled, the backlight is deactivated, and you run the risk of a computer malfunction. **Do not let the battery reach this condition!**
- Always replace the battery when the steady battery symbol appears (3 zeros).

☞ **NOTE:** Logbook information is not lost even when the battery is removed for an extended period of time.

## 2.2.8 Active backlight

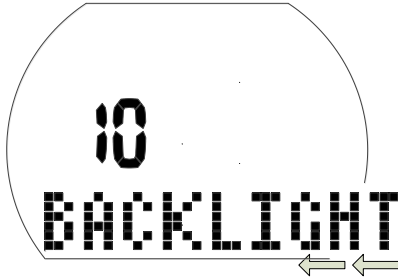



The display of the Aladin Sport can be illuminated both on the surface and under water. The backlight can be activated with a press-and-hold of the left button.

The light will turn off automatically with a default duration of 10 seconds. However, duration can be adjusted between 2 and 12 seconds. The backlight can also be set to “push on/push off” in which case the light stays on until you press the button again.

To set backlight duration:

- Starting from the time of day display, push the left or right button to get to the dive menu screen, then press-and-hold the right button.
- Press the right button 3x to get to the user settings screen, then press-and-hold the right button.
- Press the right button once to get to the backlight duration screen, then press-and-hold the right button.
- Press the left or right button to choose your backlight duration or to set push on/push off, then lock in your choice with a press-and-hold of the right button.
- Press-and-hold both left and right buttons simultaneously to return to the time of day display.

 **NOTE:** Repeated activation of the backlight will reduce battery life.

 **NOTE:** Keeping the backlight on permanently represents a severe strain on the battery. In warm waters (20°C/68°F and above), a new battery can sustain 20 to 40 1-hour dives with the backlight always on. In cold waters

(4°C/40°F and below) the low battery warning may come on within the first dive. For temperatures between 4°C/40°F and 20°C/68°F the life of a new battery will fall somewhere between 1 and 20 1-hour dives.

The Aladin Sport monitors the battery level throughout every dive, and if the available energy drops below the warning threshold, the Aladin Sport will automatically disable the backlight to prevent a computer shut-down.

## 2.2.9 Switching off the display

From the time of day display you can switch off the Aladin Sport by pressing and holding both buttons simultaneously. On the surface the Aladin Sport switches off automatically after 3 minutes of non-use.

## 2.2.10 Alarm clock

The alarm clock tone works only at the surface.

If the alarm clock is “on” the time of day display shows the alarm clock/transmit symbol.



When the alarm is triggered, the alarm clock/transmit symbol flashes and special attention beeps sound for 30 seconds or until you press a button.

## 2.3 SOS mode



SOS mode (lock duration 24 hours) and surface interval from the dive

If you remain above a depth of 0.8m/3ft for more than 3 minutes without observing a prescribed decompression stop, the Aladin Sport will automatically switch into SOS mode after the dive and remain there for 24 hours. The dive will be entered in the logbook with "SOS."

Push the right button to see the "SOS" symbol (the SOS mode will be unlocked after 24 hours).

While in SOS mode, the Aladin Sport cannot be used for diving. It can, however, be used in gauge mode (see chapter: **Gauge Mode**, section: **Diving in gauge mode**).

**NOTE:** Diving within 48 hours after exiting SOS mode will result in shorter no-stop times or longer decompression stops.

## ⚠ WARNING

- Serious injury or death may result if you do not seek immediate treatment should any signs or symptoms of decompression sickness occur after a dive.
- **DO NOT** dive to treat symptoms of decompression sickness!
- Diving in SOS mode is extremely dangerous and you must assume full responsibility for such behavior. SCUBAPRO will assume no liability.

**NOTE:** A diving accident can be analyzed at any time in the logbook and downloaded to a PC by means of the Bluetooth interface and LogTRAK software.

## 3. DIVING WITH YOUR ALADIN SPORT

### 3.1 Terminology/Symbols

The information on the display of the Aladin Sport varies depending on the kind of dive and the dive phase.

**NOTE:** For information on diving with microbubble (MB) levels see chapter: **Diving with your Aladin Sport**, section: **Diving with microbubble (MB) levels**. For diving with multiple gases, see section: **Diving with 2 or 3 gas mixtures**.

#### 3.1.1 General terminology/Display during no-stop phase

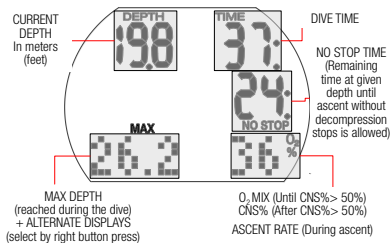

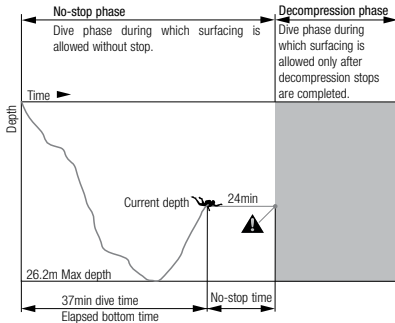

### 3.1.2 Display during decompression phase

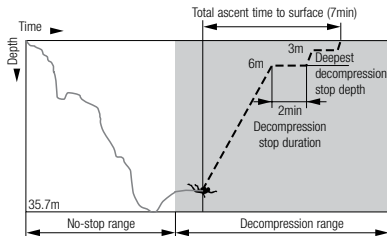
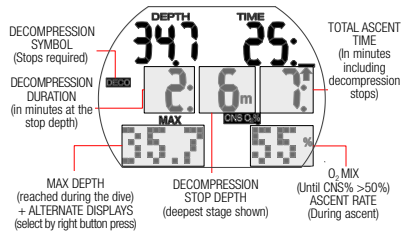

### 3.1.3 Nitrox information (O<sub>2</sub> information)

For dives with compressed air in normal recreational diving, nitrogen is the decisive gas for decompression calculations. When diving with nitrox, the risk of oxygen toxicity rises with the increase of the fraction of oxygen and the increase of depth; this can limit dive time and max depth. The Aladin Sport includes this in its calculations and displays the necessary information:

**O<sub>2</sub>% mix Fraction of oxygen:** The fraction of oxygen in the nitrox mixture can be set between 21% (normal compressed air) and 100% in 1% increments. Your selected mix will be the basis for all calculations.

**ppO<sub>2</sub> max Maximum allowed partial pressure of oxygen:** The higher the fraction of oxygen in the mixture, the shallower the dive depth at which this value of the partial pressure of oxygen is reached. The depth at which the ppO<sub>2</sub> max is reached is called Maximum Operating Depth (MOD).

When you enter the settings for the gas mixture, the Aladin Sport will display the ppO<sub>2</sub> maximum limit setting and the corresponding MOD. The Aladin Sport warns you audibly and visually once the depth is reached at which the ppO<sub>2</sub> reaches the maximum allowed value.

**NOTE:** The default setting of ppO<sub>2</sub> max is 1.4bar. The value of ppO<sub>2</sub> max can be set between 1.0bar and 1.6bar at the gas settings. It can also be changed to "off" (-) which requires Code 313. The CNS O<sub>2</sub>% value/alarm is not influenced by the selected ppO<sub>2</sub> max setting.

**CNS O<sub>2</sub>% Oxygen toxicity:** With the increased percentage of oxygen, the oxygen in the tissues, especially in the central nervous system (CNS), becomes important. If the partial pressure of oxygen rises above 0.5bar, the CNS O<sub>2</sub> value increases; if the partial pressure of oxygen is below 0.5bar, the CNS O<sub>2</sub> value decreases. The closer the CNS O<sub>2</sub> value is to 100%, the closer the limit where symptoms of oxygen toxicity can occur.

During the dive, the depth at which ppO<sub>2</sub> reaches 0.5bar with various commonly-used mixes is as follows:

MIX	DEPTH in meters	DEPTH in feet
21%	13m	43ft
32%	6m	20ft
36%	4m	13ft

**⚠ WARNING**

**Nitrox diving should only be attempted by experienced divers after proper training from an internationally recognized agency.**

### 3.2 Attention messages and alarms

The Aladin Sport draws the diver's attention to certain situations and warns of unsafe diving practices. These attention messages and alarms are visual and/or audible.

#### 3.2.1 Attention messages

Attention messages are communicated visually using symbols, letters or flashing figures. In addition, 2 short audible sequences can be heard (in an interval of 4 seconds) in 2 different frequencies under water.

Attention messages come up in the following situations:

- Maximum operating depth/ppO<sub>2</sub> max is reached.
- Set max depth is reached.
- Oxygen toxicity reaches 75%.
- No-stop time is less than 3 minutes.
- Prohibited altitude (surface mode).
- Entering decompression (when diving with MB L0).
- Half of set dive time is reached.
- Set dive time is reached.
- Depth for tank switch has been reached.

Diving with MB levels (L1-L5):

- MB no-stop time = 0.
- MB level stop is ignored.
- MB level is reduced.
- Entering decompression when diving with MB level L1-L5.

#### 3.2.2 Alarms

Alarms are provided visually by flashing symbols, letters or figures. In addition, an audible sequence in one frequency can be heard during the whole duration of the alarm.

An alarm occurs in the following situations:

- Oxygen toxicity reaches 100%.
- Ignored decompression.
- Exceeding the prescribed ascent rate.
- Altitude alarm.
- Low battery alarm (without audible alarm): battery icon appears if battery has to be replaced.
- Apnea mode alarm.

 *NOTE: Audible attention messages can be switched off in the watch settings mode (by pressing the right button 5x to the sounds screen) or in LogTRAK. With LogTRAK sounds can be switched off selectively or completely.*

**⚠ WARNING**

**If you turn off all sound you will have no audible warnings. Without audible warnings you could inadvertently find yourself in potentially hazardous situations which could result in death or serious injury.**

**⚠ WARNING**

**Serious injury or death may result from failing to immediately respond to alarms provided by the Aladin Sport.**

### 3.3 Preparation for the dive

It's important to check the settings of the Aladin Sport, especially before the first dive. All settings can be checked and changed directly on the Aladin Sport or by using LogTRAK and a PC.

#### 3.3.1 Function check

To test the display, turn on your Aladin Sport with a press-and-hold of the left button. Are all elements of the display activated? Do not use your Aladin Sport if the display does not show all elements. (When switching on the Aladin Sport with the right button the test display will not appear.)

## ⚠ WARNING

Always check the battery capacity before each dive. See chapter: **System and Operation**, section: **Check the battery**.

### 3.3.2 Setting the gas mixture and $ppO_2$ max

To set the gas mixture, the Aladin Sport must be in the dive display (showing time of day, temperature and gas percentage):

1. Press-and-hold the right button to get to the GAS screen, then press-and-hold the right button again to get to the GAS 1  $O_2$  menu.

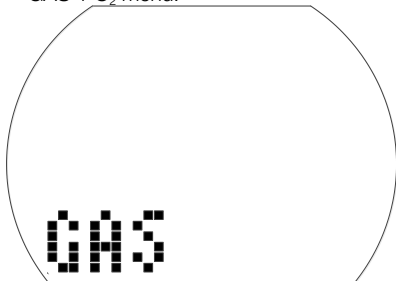

2. Confirm that you wish to change the oxygen fraction of gas 1 with a press-and-hold of the right button.
3. By pressing either the left or right button you can change the oxygen fraction in increments of 1%. The Aladin Sport will display the current fraction of oxygen, the maximum partial pressure limit ( $ppO_2$  max) and the MOD.
4. Confirm your selected percentage with a press-and-hold of the right button.
5. Next, by pushing the left or right button you can change the  $ppO_2$  max for your chosen fraction of oxygen down to 1.0bar. The Aladin Sport will now display the corresponding MOD for the new  $ppO_2$  max.
6. Confirm your  $ppO_2$  max setting with a press-and-hold of the right button.

☞ NOTE: Without confirmation via a press-and-hold of the right button the display will disappear after 3 minutes and your entries will not be accepted. Automatic reset of the  $O_2$ % mix to 21% can be set between 1 and 48 hours or to "no reset" (default).

## ⚠ WARNING

Before every dive and after changing the tank, make sure that the settings for the gas mixture correspond to the current mixture being used. An incorrect setting will cause the Aladin Sport to miscalculate the dive. If the fraction of oxygen is set too low, oxygen poisoning can occur without warning. If the value is set too high, decompression sickness may occur. Inaccuracies in the calculations are carried over to repetitive dives.

### 3.3.3 Preparation for diving with 2 or 3 gas mixtures

See chapter: **Diving with your Aladin Sport**, section: **Diving with 2 or 3 gas mixtures**.

### 3.3.4 Setting the MB level

See chapter: **SETTINGS**, section: Setting the MB Level.

## 3.4 Functions during the dive

### 3.4.1 Alternate displays

By pushing the right button during the dive you can scroll through the alternate displays (Max depth > Temperature > Time, Temperature).

You can get back to the first display by:

- Scrolling with the right button through the displays.
- Without taking any action, after 5 seconds the display automatically switches back to the original display.



### 3.4.2 Setting bookmarks

During the dive you can create bookmarks in your dive profile with a press of the left button. An audible signal confirms the creation of the bookmark. These bookmarks will be graphically displayed in the dive profile of LogTRAK.

### 3.4.3 Dive time

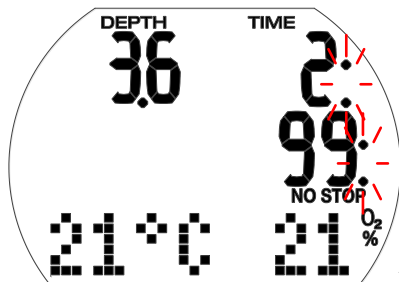

All time spent below a depth of 0.8m/3ft is displayed as dive time in minutes. The time spent above 0.8m/3ft is counted as dive time only if you once again descend below 0.8m/3ft within 5 minutes.

While the dive time is running, the colors to the right of the figures are flashing in 1-second intervals.

The maximum dive time displayed is 199 minutes. If a dive lasts longer than 199 minutes the dive time display starts again at 0 minutes.

**NOTE:** Half time alarm (turn around alarm): If half of the set maximum dive time has elapsed, an audible signal will sound and the  symbol flashes for 1 minute.

When the set dive time has elapsed an audible alarm sounds and the dive time starts flashing.

### 3.4.4 Current depth/O<sub>2</sub>% mix

Current depth is given in 10cm increments in the metric setting and 1ft increments in the imperial setting.

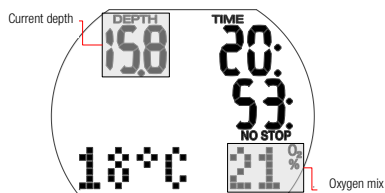

At a diving depth of less than 0.8m/3ft the display shows " --- ".

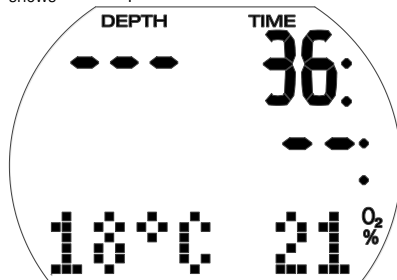

### 3.4.5 Max depth/Temperature

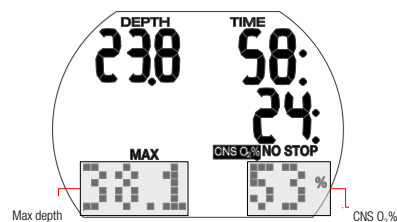

Max depth is displayed only if it exceeds the current depth by more than 1m/3ft (maximum indicator function). In the absence of max depth the Aladin Sport displays temperature.

The O<sub>2</sub>% mix is displayed as long as the CNS O<sub>2</sub>% is less than 50%. More than 50% and the CNS O<sub>2</sub>% is displayed.

### 3.4.6 Set max depth reached

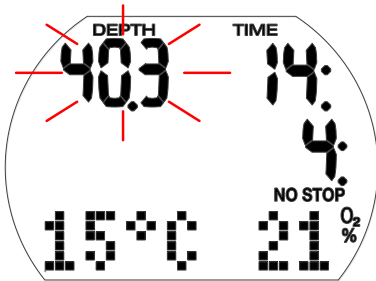

#### ⚠ WARNING

If the set max depth has been reached (default 40m/130ft) and the depth alarm is turned on, the alarm tone sounds and the depth display flashes. Ascend until the depth stops flashing.

### 3.4.7 Ascent rate

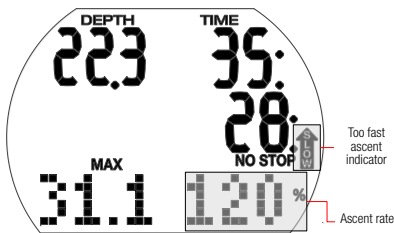

Optimal ascent rate varies depending on depth between 7 and 20m/min (23 and 67ft/min). It is displayed as a percent of the reference variable ascent rate. If the ascent rate is greater than 100% of the set value, the vertical black arrow with “SLOW” appears. If the ascent rate exceeds 140%, the arrow starts flashing.

The Aladin Sport provides an audible alarm if the ascent rate is 110% or greater. The intensity of the alarm increases in direct proportion to the degree that the prescribed ascent rate is exceeded.

#### ⚠ WARNING

The prescribed ascent rate must be observed at all times! Exceeding the prescribed ascent rate can lead to microbubbles in the arterial circulation which can lead to serious injury or death due to decompression sickness.

- In case of an improper ascent the Aladin Sport may require a decompression stop, even within the no-stop phase, because of the danger of microbubble formation.
- The decompression duration necessary for the prevention of microbubbles can increase massively if the ascent rate is exceeded.
- From great depths a slow ascent may cause heightened saturation of tissues and an extension of both decompression duration and total ascent time. At shallow depths, a slow ascent may shorten the decompression duration.
- Display of the ascent rate has the priority over “CNS O<sub>2</sub>”.

Excessive ascent rates for longer periods are entered in the logbook. The following ascent rates correspond to the 100% value in the Aladin Sport.

DEPTH		ASC SPEED	
m	ft	m/min	ft/min
0	0	7	23
6	20	8	26
12	40	9	29
18	60	10	33
23	75	11	36
27	88	13	43
31	101	15	49
35	115	17	56
39	128	18	59
44	144	19	62
50	164	20	66

### 3.4.8 Partial pressure of oxygen (ppO<sub>2</sub> max)/Maximum operating depth (MOD)

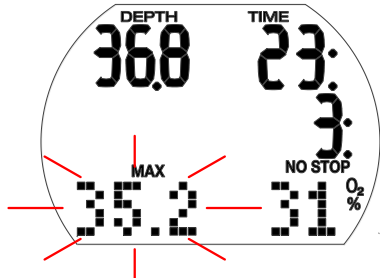

The maximum partial pressure of oxygen (ppO<sub>2</sub> max), with a default of 1.4bar, determines the Maximum Operating Depth (MOD). Diving deeper than the MOD exposes you to oxygen partial pressures higher than the set maximum level.

The ppO<sub>2</sub> max, and consequently the MOD, can be reduced manually when setting the gas. See chapter: **Settings**, section: Gas menu.

#### ⚠ WARNING

The MOD is a function of ppO<sub>2</sub> max and the mixture used. If during the dive the MOD is reached or exceeded, the Aladin Sport sends an audible attention message and the MOD is displayed (flashing) in the lower left corner. If this occurs, ascend to a depth shallower than the displayed MOD in order to diminish the danger of oxygen poisoning.

#### ⚠ WARNING

The MOD should not be exceeded. Disregarding the warning can lead to oxygen poisoning.

### 3.4.9 Oxygen toxicity (CNS O<sub>2</sub>%)

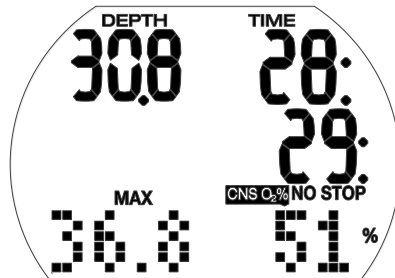

The Aladin Sport calculates oxygen toxicity based on depth, time and gas mixture, and displays it in the lower right corner when the value is greater than 50%. The toxicity is expressed in 1% increments of a maximum tolerated value (CNS O<sub>2</sub> clock).

The symbol "CNS O<sub>2</sub>" is displayed together with the percentage.

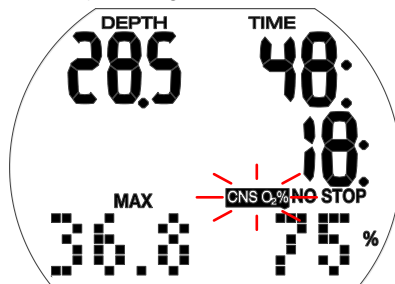

#### ⚠ WARNING

An audible attention signal starts if oxygen toxicity reaches 75%. The symbol "CNS O<sub>2</sub>" flashes.

Ascend to a shallower depth to decrease oxygen loading, and consider terminating the dive.

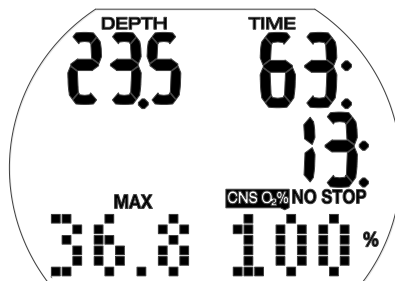

**⚠ WARNING**

When oxygen toxicity reaches 100%, an audible alarm sounds every 4 seconds. "CNS O<sub>2</sub>" and the percentage value flash, indicating the danger of oxygen toxicity! Start procedure for terminating the dive.

👉 NOTE:

- During an ascent, and if the CNS O<sub>2</sub>% value does not increase (due to a lower partial pressure of oxygen), the audible warning is suppressed.
- During an ascent, the display of the oxygen toxicity is replaced by the ascent rate. If the ascent is stopped, the display changes back to the indication of the CNS value.
- The Aladin Sport displays CNS O<sub>2</sub>% values exceeding 199% with 199%.
- The Aladin Sport displays CNS O<sub>2</sub>% values above 50%.

**3.4.10 Decompression information**

NO STOP and the no-stop time (in minutes) are displayed if no decompression stops are necessary.

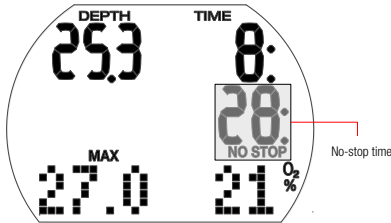

👉 NOTE:

- A no-stop display of "99:" means there is remaining time of 99 minutes or more.
- No-stop time is influenced by the water temperature.

**⚠ WARNING**

If no-stop time drops below 3 minutes, an audible attention signal is activated and the no-stop value begins to flash. If no-stop time is less than 1 minute, the no-stop display shows the flashing value "0".

In order to prevent a decompression dive, ascend slowly until the no-stop time is 5 minutes or more.

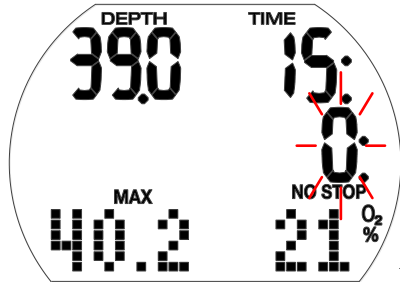

**⚠ WARNING**

Decompression diving requires advanced training from a recognized agency. Do not attempt decompression diving without proper training from a recognized agency.

**3.4.11 Decompression values**

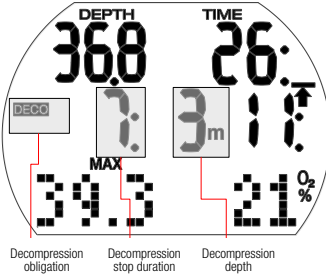

On entering the decompression phase, "NO STOP" disappears, "DECO" appears and the audible attention beep sounds. The "STOP" arrow appears next to the "DECO" symbol when the diver is at decompression range (1.5m / 5ft below the stop).

The deepest decompression stage in meters/feet is displayed and the decompression stop duration of the displayed stage appears in minutes.

The display “7: 3m” means that a decompression stop of 7 minutes at a depth of 3m/10ft has to be made.

When a decompression stop has been completed, the next (shallower) decompression stop is displayed.

When all decompression stops have been completed, the “DECO STOP” symbol disappears and the “NO STOP” symbol along with the no-stop time reappears.

Deco stop depths deeper than 27m/90ft are displayed as “- - : - -”.

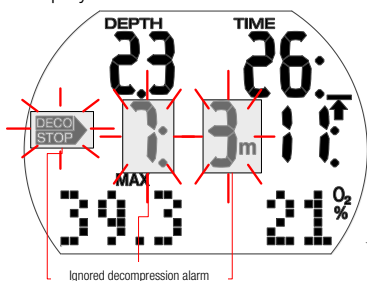

### ⚠ WARNING

The decompression alarm is activated if the decompression stop is ignored. The “DECO STOP” arrow, the decompression stop duration, and the decompression stop depth begin to flash and an audible alarm sounds. Due to the formation of microbubbles, decompression can increase massively if a decompression stop is ignored. Descend to the prescribed decompression stop depth immediately!

When the surface is reached during the decompression alarm, the “DECO STOP” arrow, the decompression stop duration, and decompression stop depth continue flashing in order to point to the risk of a decompression accident. The SOS mode is activated 3 minutes after the dive if corrective action is not taken. If the total (cumulative) duration of the decompression alarm is longer than one minute, it is entered in the logbook.

### 3.4.12 Total ascent time

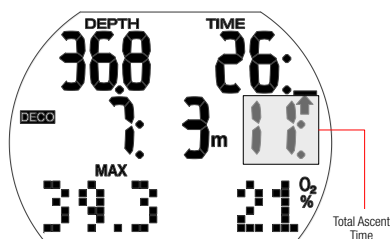

As soon as decompression stops are necessary, the Aladin Sport shows the total time of ascent. This includes the ascent time from the current depth to the surface as well as all decompression stop obligations.

**NOTE:** The total time of ascent is calculated on the basis of the prescribed ascent rate. Total time of ascent can be subject to change if the ascent rate is not ideal (100%). Ascent time greater than 99 minutes is displayed as “- -”.

### ⚠ WARNING

On all dives with the Aladin Sport, make a safety stop for at least 3 minutes at a depth of 5m/15ft.

### 3.4.13 Safety stop timer

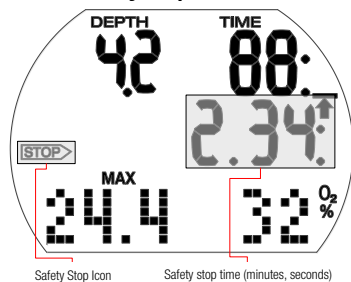

The safety stop timer displays the time a diver should spend at the safety stop depth at the end of the dive. The timer starts automatically when depth is shallower than 5m/15ft and counts back from 3 minutes (default) to zero. It can be restarted manually any number of times. The duration of the timer can be set between 1 and 5 minutes.

The safety stop timer will be activated under the following conditions: depth <5m/15ft; no-stop display of 99 min; the gauge mode is switched off; stop time is selected (1-5 min) in the scuba mode menu.

You can activate the safety stop timer by pressing the left button. The timer begins to count backwards and a bookmark will be created in the dive profile. If you press again, the timer will start again from the full value.

The safety stop timer will switch off automatically if the depth exceeds 6.5m/21ft or the no-stop phase is shorter than 99 minutes.

### 3.5 Functions after the dive

#### 3.5.1 End of a dive

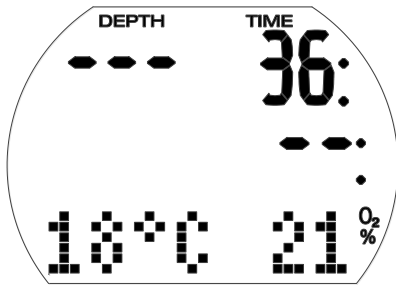

After reaching the surface (<0.8m/3ft) the Aladin Sport remains in dive mode for 5 minutes. The delay allows for surfacing for a short period for orientation.

After 5 minutes, the dive is closed and is entered into the logbook. The desaturation time, the no-fly time, the no-dive warning (if applicable), the current altitude class and the prohibited altitude class are displayed for 3 minutes, after which the computer turns off.

#### ⚠ WARNING

For calculations of desaturation and no-fly time it is assumed that you are breathing air while on the surface.

#### 3.5.2 Desaturation time, No-fly time and No-dive warning

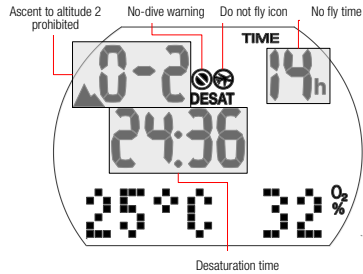

5 minutes after a dive the Aladin Sport shows the desaturation time, the no-fly time, the no-dive warning (if applicable), the current altitude class and the prohibited altitude class – see chapter: **Diving with your Aladin Sport**, section: **Prohibited altitude**.

No-fly time is the time in hours that should pass before flying. It is displayed until the value counts down to 0 hours.

#### ⚠ WARNING

Flying while the Aladin Sport displays the “do not fly” icon may lead to serious injury or death from decompression sickness.

#### ⚠ WARNING

If the “no-dive” warning is visible during the surface interval, you should not undertake another dive.

To check the elapsed surface interval and oxygen toxicity, press-and-hold the right button.

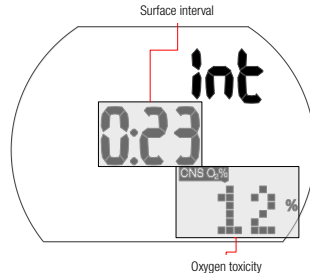

Desaturation time is determined either by oxygen toxicity, nitrogen saturation or the regression of microbubbles, depending on which requires the longer time.

### No-dive warning

If the Aladin Sport detects a situation of increased risk (due to the potential of microbubble accumulation from previous dives or a CNS O<sub>2</sub> level above 40%), the “no-dive” symbol will appear on the display.

The duration of the no-dive warning is visible in the dive planner menu. The Aladin Sport recommends this as a minimum surface interval in order to reduce the number of microbubbles and/or to reduce the CNS O<sub>2</sub> level below 40%.

 **NOTE:** You should not undertake a dive as long as the no-dive warning message is displayed on the computer screen. If the warning is prompted by microbubble accumulation (as opposed to CNS O<sub>2</sub> over 40%) and you dive anyway, you will have shorter no-stop times or longer decompression times. Moreover, the duration of the no-dive warning at the end of the dive can increase considerably.

## 3.6 Diving in mountain lakes

### 3.6.1 Altimeter

The altitude adjustment (see chapter: **SETTINGS, section: Altitude adjustment**) does not affect altitude classes nor any calculations.

### 3.6.2 Altitude classes

The Aladin Sport measures the atmospheric pressure every 60 seconds, even while the display is switched off. If the computer detects a sufficient increase in altitude, it switches on automatically and indicates the new altitude class (1-4) and the desaturation time. Desaturation time indicated at this moment refers to the adaptation time at this altitude. If the dive starts within this adaptation time, the Aladin Sport treats it as a repetitive dive, since the body is off-gassing.

Altitude is divided into 5 classes, which are influenced by barometric pressure. That is why the defined altitude classes overlap on their fringes. If a mountain lake is reached, the altitude class is indicated at the surface (time of day display), in the logbook and in the dive planner with a stylized mountain icon and the current altitude class. The altitude from sea level to approximately 1000m/3280ft is not indicated. In the following diagram, you can see the approximate breakdown of the altitude classes:

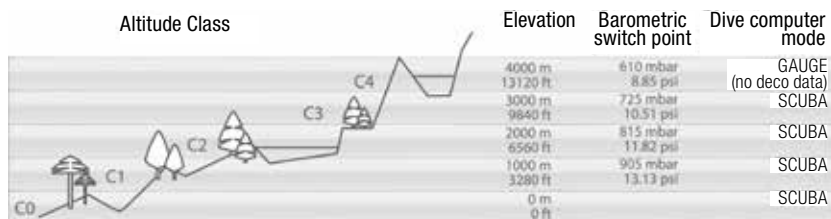

### 3.6.3 Prohibited altitude



Ascent to altitude class 3 and 4 is prohibited. Maximum allowed altitude: 2650m/8694ft.

#### ⚠ WARNING

**At the surface, the Aladin Sport shows, via flashing altitude class number, the altitude to which you may not rise. The ascent prohibition is displayed together with the current altitude class.**

Example:



You are at 1200m/3937ft (altitude class 1) and you may ascend to class 2 only (2650m/8694ft). You may not rise to the altitude classes 3 or 4.

#### ⚠ WARNING

**If an ascent to a prohibited altitude is detected, an audible alarm sounds for 1 minute. Descend to a lower altitude.**

### 3.6.4 Decompression dives in mountain lakes

In order to assure optimal decompression even at higher altitudes, the 3m/10ft decompression stage is divided into a 4m/13ft stage and a 2m/7ft stage in altitude classes 1, 2 and 3. The prescribed decompression stop depths are in sequence (2m/7ft, 4m/13ft, 6m/20ft, 9m/30ft...).

If atmospheric pressure is below 620mbar/8.99psi (altitude higher than 4100m/13450ft above sea level), the Aladin Sport switches automatically to gauge mode and no decompression data is calculated or displayed. In addition, the dive planner is no longer available. For more information on diving in gauge mode, refer to the following section.

## 3.7 Gauge mode

Gauge mode does not support the calculation of no-stop time or the supervision of decompression. Supervision of ppO<sub>2</sub> max and CNS O<sub>2</sub>% are also switched off. In gauge mode the Aladin Sport displays no information on microbubble development or settings for gas mixture. MOD and microbubble levels cannot be set and the dive planner cannot be selected.

#### ⚠ WARNING

**In gauge mode, ALL audible and visual alarms and attention messages are turned off and the Aladin Sport displays depth, dive time and max depth.**

### 3.7.1 Switching the gauge mode on and off

Gauge mode can be switched on and off at the surface when there is no desaturation, and when no dive in gauge mode has been made in the last 48 hours.

#### ⚠ WARNING

- Dives in gauge mode are performed at your own risk!
- After diving in gauge mode, the Aladin Sport cannot be used as a dive computer for 48 hours.





1. From the dive display press-and-hold the right button (“GAS” menu appears). Press the right button 4x and “ALGORITHM” menu is displayed. (If the Aladin Sport shows “OFF” the gauge mode cannot be activated or deactivated without a desaturation reset. The Aladin Sport shows “OFF” for 48 hours after a dive in gauge mode or as long as there is remaining desaturation after a dive in computer mode.)
2. Confirm with a press-and-hold of the right button that you wish to activate or deactivate the gauge mode. At this point, “Scuba”, “Gauge” or “Apnea” starts flashing.
3. By pushing the left or right button the mode will scroll between Gauge, Scuba and Apnea.  
Select: Gauge.
4. Confirm your settings with a press-and-hold of the right button. (Without confirmation the display will disappear after 3 minutes and your entries will not be accepted.)

### 3.7.2 Diving in gauge mode

The following information is displayed in gauge mode:

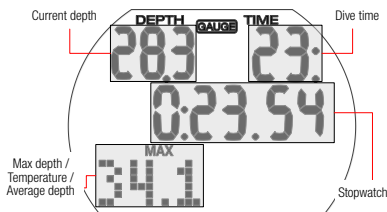

By pressing the right button you can scroll from max depth to temperature to average depth to the time of day and back to the max depth. By pressing the left button you can restart the stopwatch. This also generates a bookmark.

Average depth is continuously updated and represents the time-averaged depth since the beginning of the dive. You can reset the average depth at any time with

a press-and-hold of the right button. This also generates a bookmark.

### Stopwatch

In gauge mode, after immersion the Aladin Sport will automatically monitor the dive time and, at the same time, activate the stopwatch. The stopwatch will run for a maximum of 24 hours.

- Pressing the left button resets time and starts the stopwatch from zero.
- Each start (restart) of the stopwatch creates a bookmark.

### 3.7.3 After diving in gauge mode



The Aladin Sport shows the remaining time span during which it cannot be used in computer mode. Once the waiting period is over, the gauge mode can be switched off manually.

The no-fly time after diving in gauge mode is 48 hours. Desaturation time will not be displayed.

## 3.8 Apnea mode

### 3.8.1 Switching the apnea mode on and off

The apnea mode can be switched on and off, like the gauge mode, when there is no desaturation, and when no apnea dives have been made in the last 48 hours.

### **⚠ WARNING**

Apnea diving after scuba diving is not recommended. Check the latest recommendations from your instructor or diving organization.

## ⚠ WARNING

The Aladin Sport doesn't track your nitrogen intake while in apnea mode. Therefore, the no-fly time after apnea diving is set to 48 hours. Also, scuba diving after apnea diving is recommended only after sufficient surface time. Check the latest recommendations from your instructor or diving organization.

### Procedure:



1. From the dive display press-and-hold the right button ("GAS" menu appears). Press the right button 4x and "ALGORITHM" menu is displayed.
2. Confirm with a press-and-hold of the right button that you wish to activate or deactivate the apnea mode.
3. "Scuba", "Gauge" or "Apnea" starts flashing.
4. By pressing the right button you can scroll between modes and select the apnea mode.
5. Confirm your setting with a press-and-hold of the right button.

## ⚠ WARNING

SCUBAPRO highly recommends professional training in apnea diving techniques and physiology before conducting breath-hold dives. No dive computer can replace the need for proper dive training. Insufficient or improper training may cause you to commit errors that can lead to serious injury or death.

## ⚠ WARNING

Deep repetitive apnea dives are not recommended; leave enough recovery time between your apnea dives.

## ⚠ WARNING

All breath-hold dives include a risk of shallow water blackout; that is, a sudden loss of consciousness due to oxygen starvation. The apnea mode is comparable to the gauge mode – it doesn't have a dive algorithm and all decisions are left to the diver. Therefore SCUBAPRO recommends:

1. Never apnea dive alone.
2. Make only apnea dives that your education and physical condition allow.

In apnea diving fast descents and ascents are allowed. Therefore, the Aladin Sport uses a faster sampling of depth for higher accuracy. The Aladin Sport updates the display of maximum depth every 0.25 seconds, and the logbook is updated every second.

### 3.8.2 *Diving in apnea mode*

The following information is displayed in apnea mode during immersion:

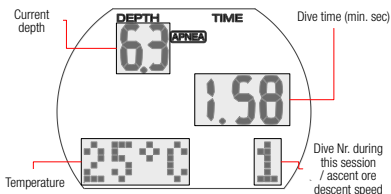

And between the apnea dives:

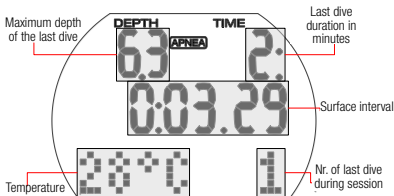

In apnea mode the dive can be started manually with a press-and-hold of the right button. This function allows a fast sampling to start straight from the surface. The

automatic start of an apnea dive will occur at a depth of 0.8m/3ft.

Once activated, the apnea mode will run 15 minutes after surfacing. This allows you to start a repetitive apnea dive with precise data in the logbook. The surface mode can be stopped with a press-and-hold of the right button.

The Aladin Sport's apnea mode has special alarms and functions tailored to apnea diving and apnea training. You can select multiple alarm functions at the same time. The alarm functions set-up is explained in the chapter: **Settings**, section: **Apnea menu**.

### 3.9 Diving with microbubble (MB) levels

Microbubbles (MB) are tiny bubbles that can build up inside a diver's body during any dive and normally dissipate naturally during an ascent and on the surface after a dive. Dives conducted within no-stop times and the observance of decompression stops do not prevent the formation of microbubbles in the venous blood circulation.

Dangerous microbubbles are those migrating into the arterial circulation. The reasons for the migration from the venous blood circulation to the arterial circulation can be a great many microbubbles collecting in the lungs. SCUBAPRO has equipped the Aladin Sport with a new technology to help protect divers from these microbubbles.

With the Aladin Sport, you can choose – according to your specific needs – a MB level that will provide a level of protection from microbubbles. Diving with MB levels includes additional ascent stops (level stops); this slows the ascent process, giving the body more time to desaturate. This works contrary to the formation of the microbubbles and increases safety.

The Aladin Sport features 6 microbubble levels (L0-L5). Level L0 corresponds to SCUBAPRO's well-known decompression model ZH-L16 ADT and does not require level stops due to microbubble formation. Levels L1 to L5 offer additional protection

from microbubble formation with level L5 offering the highest protection.

Similar to the display of information during decompression dives or dives within no-stop time, the Aladin Sport displays depth and duration of the first level stop as well as the total time of ascent as soon as the MB no-stop time has run out. As the MB no-stop time is shorter than the ordinary no-stop time you will be required to perform a stop (level stop) sooner than a diver using level L0.

If you ignore a required level stop, the Aladin Sport will simply step down to a lower MB level. In other words, if you choose level L4 prior to the dive, and during the dive you ignore the L4's recommended stops, the Aladin Sport will automatically adjust the setting to level L3 or lower.

#### 3.9.1 Comparison of dives with MB level L0 and MB level L5

When two Aladin Sport dive computers are used simultaneously, with one unit set to a MB level of L5 and the other to a MB level of L0, the no-stop time for the L5 unit will be shortened and more level stops will be required before the diver has the obligation of a decompression stop. These additional level stops help dissipate microbubbles.

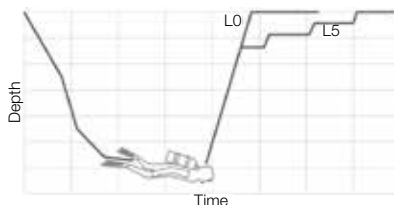

#### 3.9.2 Terminology

This section will deal exclusively with terminology and display features used while diving with MB levels.

### Display during MB no-stop phase

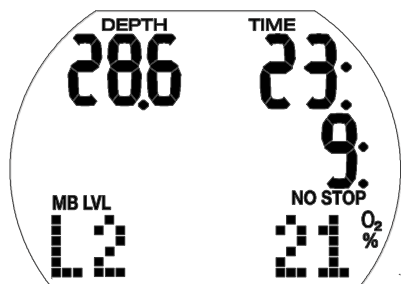
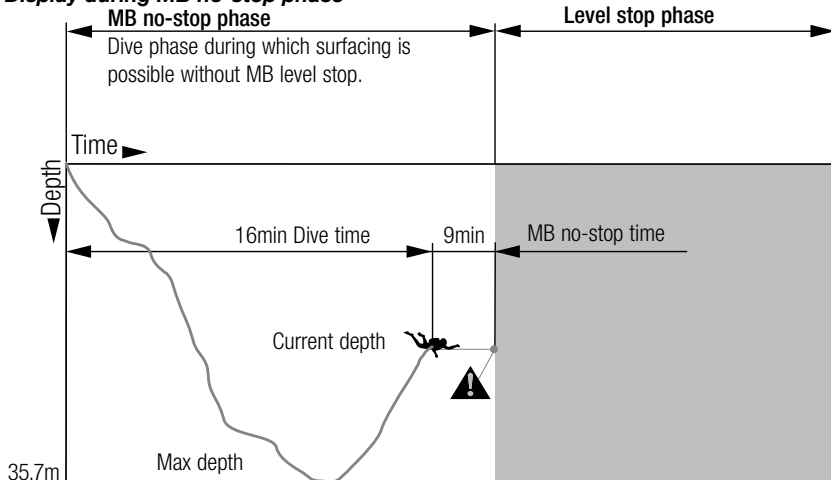

### Display during level stop phase

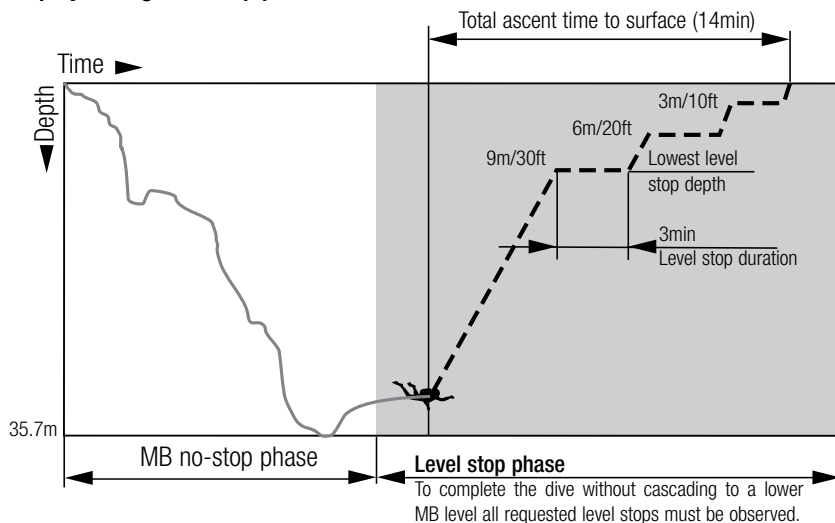

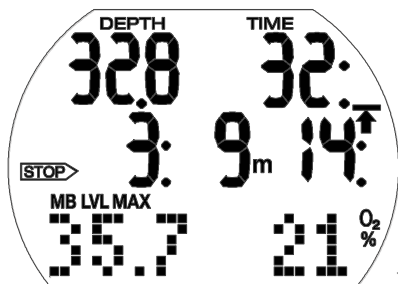

### 3.9.3 Preparation for a dive with MB levels

#### Setting the MB level

To change the MB level, see chapter: **SETTINGS**, section: Setting the MB Level.

**NOTE:** MB levels have an influence on the dive planner.

### 3.9.4 Functions during the dive with MB levels

#### Level stop information

##### MB no-stop time

While diving with MB levels L1 to L5 the Aladin Sport will display the MB no-stop time instead of the ordinary no-stop time. Within the MB no-stop time no level stops are required.

“NO STOP” and the MB level symbol are visible. The remaining MB no-stop time is shown in minutes.

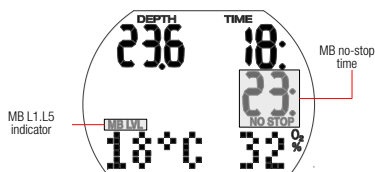

**NOTE:**

- Information and alarms for MB no-stop time and ordinary no-stop time are the same.
- No-stop time relative to L0 is shown by pressing the right button 3x.
- Regardless of the MB level, it is

generally recommended that you perform a slow ascent during the last few meters/feet.

#### Level stop

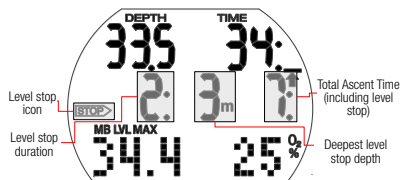

On entering the level stop phase, “NO STOP” disappears and the STOP arrow appears. The STOP arrow flashes for 8 seconds and an audible attention beep sounds. To complete the dive without cascading to a lower MB level, all requested level stops must be observed.

The deepest level stop is displayed in meters/feet. The display “2: 3m” means that a level stop of 2 minutes at a depth of 3m/10ft has to be observed. Deco information relative to L0 is shown on an alternate display (see chapter: **Diving with your Aladin Sport**, section: Decompression information).

When a level stop has been completed, the next higher level stop – if present – is displayed. When all level stops have been observed, the STOP arrow disappears and “NO STOP” reappears. The indication of time shows the MB no-stop time again.

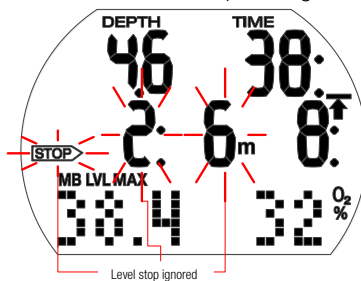

## ⚠ WARNING

The attention message “Level stop ignored” is activated if the requested level stop is not observed. An attention beep\* sounds and the STOP arrow, depth and duration of the ignored level stop begin flashing.

To complete the dive without shifting to a lower MB level, you must descend to the prescribed depth immediately!

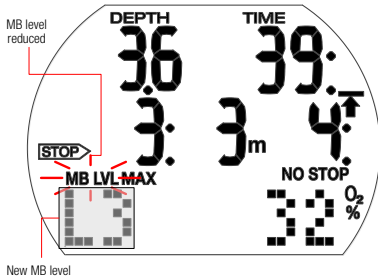

## ⚠ WARNING

The warning “MB level reduced” is activated if you ascend more than 1.5m/5ft above the required level stop. The Aladin Sport reduces the MB level, an attention beep\* sounds and the new MB level is shown in the lower left corner. To complete the dive without shifting down to an even lower MB level the new level stop must be observed.

\* Attention beeps can be suppressed. See chapter: **Settings**, section: **Switching the sound on and off**.

### Total ascent time

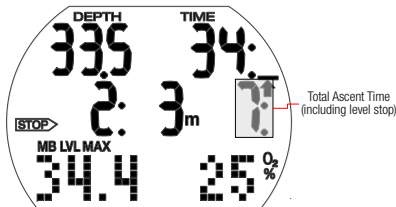

The Aladin Sport displays the level stop information and the total time of ascent. This includes the time of ascent as well as all level stops.

NOTE: The total time of ascent is calculated on the basis of the prescribed ascent rate. Total time of ascent can be subject to change if the ascent rate is not ideal (100%).

### Decompression obligation

The Aladin Sport calculates and displays level stops to reduce microbubble formation, but it also calculates the diver's decompression data.

## ⚠ WARNING

Avoid decompression dives when diving with MB levels.

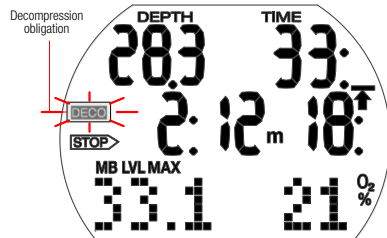

How to avoid decompression stops:

- Check ordinary no-stop time by pressing the right button until L0 appears.

## ⚠ WARNING

At the beginning of a decompression phase an attention beep sounds and the symbol flashes for 8 seconds. In order to prevent a dive with long decompression stops it is recommended that you ascend a few meters/feet upon seeing this message.

If decompression stops become obligatory, the “DECO” symbol will be displayed. The total ascent time will now also include a decompression stop.

### Level stop and deco stop

When the level stop depth equals the depth of the first obligatory decompression stop, and if you are within 1.5m/5ft of the stop depth itself, the Aladin Sport shows STOP DECO and STOP (level stop). The indicated duration refers to the level stop duration.

Since level stops are more restrictive than decompression stops, when all decompression obligations have been observed the display changes from STOP DECO to STOP only.



### 3.9.5 Completing a dive with MB levels

A dive with MB levels is completed the same way as a dive without MB levels (see chapter: **Diving with your Aladin Sport**, section: **Safety stop timer**) except for the following exceptions:

If the MB level has been reduced during the dive, the Aladin Sport will display a flashing MB level symbol and the current MB level for 5 minutes after reaching the surface. The dive is then completed and the Aladin Sport changes to user mode with the MB level switching back to the original MB setting.

Repetitive dives and MB levels: If during a dive a level stop is ignored and you start another descent shortly afterwards, the Aladin Sport might immediately request level stops. To complete the dive with the initially set MB level all level stops must be observed.

## 3.10 PDIS (Profile Dependent Intermediate Stop)

### 3.10.1 Introduction to PDIS

The main purpose of a dive computer is to track your nitrogen uptake and recommend a safe ascent procedure. Diving within the so called no-stop limits means that at the end of the dive you can ascend directly to the surface, albeit at a safe ascent rate, while for dives outside of the no-stop limit (so-called decompression dives), you must perform stops at certain depths below the surface and allow time for excess nitrogen to be expelled from your body before finishing the dive.

In both cases, it can be beneficial to stop for a few minutes at an intermediate depth between the maximum attained depth during the dive and the surface or, in case of a decompression dive, the first (deepest) decompression stop.

An intermediate stop of this kind is beneficial as soon as the ambient pressure at that depth is low enough to ensure that your body is predominantly off-gassing nitrogen, even if under a very small pressure gradient. In such a situation, you can still cruise along the reef and enjoy the dive while your body gets a chance to slowly release nitrogen.

In recent times, so called “deep” stops have been introduced in some dive computers and tables, defined as half the distance from the dive’s maximum depth and the surface (or the lowest decompression stop). Spending 2 or 15 minutes at 30m/100ft would result in the same deep stop at 15m/50ft.

With PDIS, as the name suggests, the Aladin Sport interprets your dive profile and suggests an intermediate stop that is a function of your nitrogen uptake so far. The PDI stop will therefore change through the course of the dive to reflect the continuously changing situation in your body. Along the same lines, PDIS will account for the accumulated nitrogen from previous dives; hence, PDIS is also repetitive-dive dependent. Conventional deep stops completely ignore these facts.

The following figure quantifies the extent of PDIS and illustrates its dependence on

cumulative nitrogen uptake for 2 sample dive profiles. This figure also demonstrates the conceptual difference between PDIS and the rather rudimentary “deep” stops.

Specifically, the figure compares 2 dive profiles to a maximum depth of 40m/132ft that are otherwise very different. Profile 1 stays at 40m/132ft for 7 minutes, then ascends to 30m/100ft for 3 minutes, followed by 12 minutes at 20m/65ft. Profile 2 stays less than 2 minutes at 40m/132ft, then ascends to 21m/69ft and stays there for 33 minutes. Both dive profiles are no-stop dives to the limit of entering decompression.

The solid line represents the PDIS depth as displayed on the computer screen during the course of the dive for profile 1, the broken line represents the PDIS depth as displayed on the computer screen during the course of profile 2. One can see that the displayed PDIS depth increases as more nitrogen is accumulated in the body, but does so very differently in the 2 dives due to the different exposure in the 2 profiles. The PDI stop is carried out at 25 minutes for profile 1 and at 37 minutes for profile 2, followed by the safety stop at 5m/15ft.

The line made up of small solid dots, on the other hand, represents the depth that would be displayed by a computer following the conventional deep stop method, and it would be the same for the 2 dive profiles. Deep stops completely ignore any facts about the dives themselves aside from max depth.

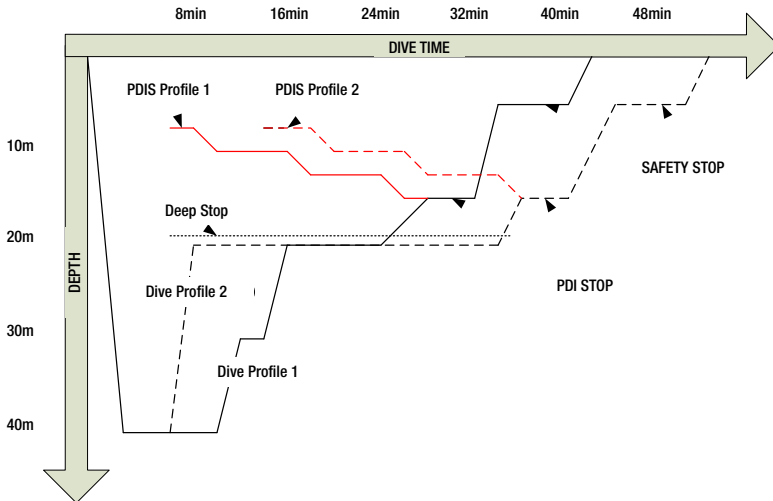

### 3.10.2 How does PDIS work?

The mathematical decompression model in the Aladin Sport, called ZH-L16 ADT MB PMG, tracks your decompression status by dividing your body into 16 so-called compartments and mathematically following the uptake and release of nitrogen in each with the appropriate laws of physics. The various compartments simulate parts of your body such as central nervous system, muscles, bones, skin and so on.

The depth of the PDI stop is calculated as that at which the leading compartment for the decompression calculation switches from on-gassing to off-gassing, and the diver is advised to perform a 2-minute stop above the displayed depth (this is the opposite of a decompression stop, where you are asked to remain just beneath the displayed depth). During this intermediate stop, the body is not taking up any more nitrogen in the leading compartment, but rather releasing nitrogen (though under a very small pressure gradient). This,



combined with the relatively high ambient pressure, inhibits bubble growth.

It should be noted that the 4 fastest compartments, up to 10 minutes half-times, respectively, are not considered for the determination of the PDI stop depth. This is due to the fact that these compartments are only “leading” for very short dives, for which an intermediate stop is not required at all.

 **NOTE:** The PDI stop is not a mandatory stop and it is **NOT** a substitute for the 3-5 minute safety stop at 5m/15ft.

## WARNING

**Even when performing a PDI stop, you still MUST perform a safety stop at 5m/15ft for 3 to 5 minutes. Performing a 3 to 5 minute stop at 5m/15ft at the end of any dive remains the best thing you can do for yourself!**

### 3.10.3 Special considerations when diving with more than one gas mixture (Aladin Sport)

Switching to a higher oxygen concentration mix during the dive influences the PDI stop. This needs to be accounted for, in line with the predictive nature of multi-gas handling in ZH-L16 ADT MB PMG.

When diving with more than one gas mixture, the Aladin Sport displays the PDIS depth according to the following rules:

- If the PDI stop calculated for the bottom mix (gas 1) is deeper than the switch depth, than this calculated value is displayed.
- If the PDI stop calculated for gas 1 is shallower than the switch depth to gas d, then the displayed PDI stop is a function of gas d.

In case of a missed gas switch, the Aladin Sport reverts to the PDI stop for the actively breathed mix.

### 3.10.4 Diving with PDIS

 **NOTE:** To use the PDIS feature, you must enable PDIS (see chapter: **Settings**, section: Setting PDIS).

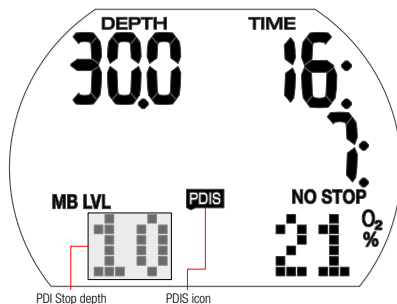

When the calculated PDI stop is deeper than 8m/25ft, the Aladin Sport shows it on the display and continues to do so until you reach the displayed depth during an ascent. The displayed value changes during the dive as the Aladin Sport tracks the uptake of nitrogen in the 16 compartments and updates the PDIS depth accordingly to reflect the optimum at all times.

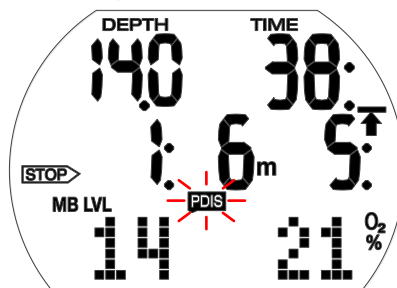

The PDIS depth is shown in the lower left corner, with the PDIS icon. During a no-stop dive, as soon as you reach that depth during an ascent, a 2-minute countdown will appear in place of the no-stop value with the label STOP. In addition, the PDIS label will blink. You can have one of 3 situations:

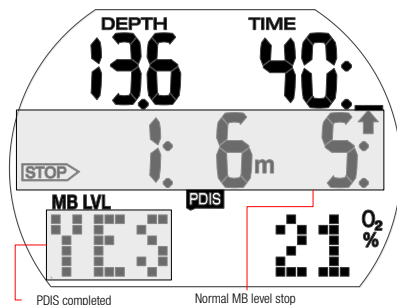

- You have spent 2 minutes within 3m/10ft above the indicated depth. The countdown timer disappears and the PDIS value is replaced by the label YES as an indication that you have performed the PDI stop.
- You have descended more than 0.5m/2ft below the PDIS. The countdown timer disappears and will reappear again, starting at 2 minutes, the next time you ascend to the PDIS depth.
- You have ascended more than 3m/10ft above the PDIS. The PDIS value and countdown timer are replaced by the label NO to indicate the fact that you have not performed the PDI stop.

If the Aladin Sport is displaying a decompression obligation when you reach the PDIS depth during an ascent, all rules apply the same way, but the 2-minute countdown runs in the background and is not displayed on the screen. The PDIS label, however, will still be blinking, indicating that you are in the PDIS range.

**NOTE:** The Aladin Sport issues no warnings relating to a missed PDI stop.

When diving with MB levels, PDIS follows the same rules as described above. MB levels, however, introduce stops earlier and deeper than the L0 base algorithm. As such, the PDIS display may be delayed and for certain dives it may not be displayed at all. This, for example, would be the case for a shallow dive with air (21% oxygen) and MB level L5.

### 3.11 Diving with 2 or 3 gas mixtures

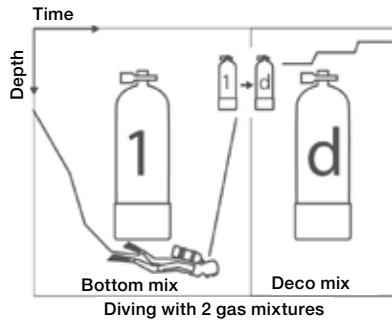

**NOTE:** The following chapter deals with the characteristics of diving with 2 or 3 gases. When using 2 gas mixtures (gas 1 and d), just ignore the parts describing gas 2.

The Aladin Sport enables you to use up to 3 different nitrox mixtures during the same dive. Tank 1 contains the bottom mix (gas 1), tank 2 the travel mix, and tank d contains the deco mix (gas d).

#### Setting the gas mixture and the depth for changing the gas mixture

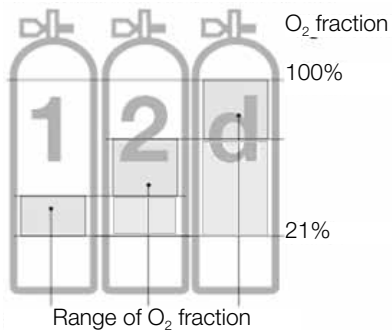

During dives with 2 or 3 gas mixtures the bottom mix (gas 1) contains the lowest fraction of oxygen and gas d the highest fraction of oxygen. The Aladin Sport will only accept settings corresponding with this order.

## ⚠ WARNING

For gas mixtures having an oxygen percentage of 80% or greater, the ppO<sub>2</sub> is fixed at 1.6bar and cannot be altered in any way.

Procedure:

1. To enter the setting for the fraction of oxygen and the ppO<sub>2</sub> max (MOD) for gas 1 (bottom mix), see chapter: **Settings**, section: **Gas menu**.
2. Repeat the process for gas 2 and the gas d. Note that in these cases the resulting MODs correspond to the depths at which you plan to switch from gas 1 to gas 2 and from gas 2 to gas d during the ascent phase.
3. If you set gas 2 and gas d to “– O<sub>2</sub>%”, the Aladin Sport will compute the dive considering gas 1 only.

The Aladin Sport will only accept gas switch depths (MOD gas 2/gas d) as input where the maximum partial pressures of oxygen (ppO<sub>2</sub> max) are not exceeded.

👉 NOTE:

- During the ascent an audible and visual attention message will indicate that you have reached the depth which requires the change to gas 2 or gas d.
- Without confirmation, the display will disappear after 30 seconds and your entries will not be accepted.
- If the oxygen fraction of gas 2/gas d is set to a value other than “–O<sub>2</sub>%” in surface mode, and up to a depth of 0.8m/3ft, the Aladin Sport will display “2G” or “3G” in the lower right corner of the display instead of a percentage value.

👉 NOTE:

- If you occasionally dive nitrox, you can use the automatic nitrox reset time to normal air function. After the reset, the oxygen fraction of gas 1 is set to 21%, and the oxygen fractions of gas 2 and gas d are set to “– O<sub>2</sub>%” (single gas dive).

### Functions during a dive with 2 or 3 gas mixtures

## ⚠ WARNING

Diving with 2 or 3 gas mixtures represents a much higher risk than diving with a single mixture, and mistakes by the diver may lead to serious injury or death.

During dives with several gas mixtures, always make sure you are breathing from the tank you intended to breath from. Mark all your tanks and regulators so they can under no circumstances be mixed up! Before every dive and after changing a tank, make sure that each gas mixture is set to the correct value for the corresponding tank.

### Predictive decompression prognosis

The calculation of decompression data is based on the assumption that the change(s) of gas mixture(s) will be performed at the previously selected switch depth(s) (MOD gas 2/gas d). If you ignore a required change or change the mixture belatedly, the Aladin Sport will readjust the decompression calculation accordingly. In case of an ignored switch the dive computer will then base its calculations on the assumption that you will ascend to the surface without using the proposed gas.

### Alternate displays during a dive with 2 gases

1. The default display shows the predictive decompression prognosis, which assumes the diver will switch to the deco gas at the specified switch depth. In the bottom left corner the temperature is displayed unless the current depth is 1m/3ft shallower than the max depth, in which case the max depth is displayed.
2. Upon pressing the right button, the temperature and the current CNS% are shown in the lower row. CNS% will time out after 5 seconds while the temperature remains.
3. Upon pressing the right button, “GAS 1”, “GAS 2” or “GAS d” appears in the middle row to indicate the currently active gas, and the MOD appears in the bottom left corner. “GAS 1”, “GAS 2” or

- “GAS d” will time out after 5 seconds unless the right button is pressed again.
- Pressing the right button one more time shows the  $O_2\%$  of the active gas in the bottom right corner and the decompression information in case the dive would be finished with the currently active gas (no switch to gas 2/deco gas). This is the calculation that the Aladin Sport would switch to in case, having reached the switch depth(s), the diver did not confirm the switch(es). The decompression information and the  $O_2\%$  blink.
  - If an MB level greater than L0 is active, pressing the right button one more time shows the predictive decompression information and, in the bottom left corner, the currently active MB level.
  - Pressing the right button again shows the predictive decompression information relative to L0 together with the L0 symbol at the bottom left.
  - One more right button push shows the decompression information relative to L0 if only the current gas is used, with the decompression information and the  $O_2\%$  of the current gas blinking.
  - Upon pressing the right button again, the time of day appears in the middle row.

☞ **NOTE:** All displays time out after 5 seconds and the default display is shown again. The only exceptions are temperature and Compass with an adjustable time out from 5 to 60 seconds or push on/off.

### Changing the gas mixture

☞ **NOTE:** After immersion, the Aladin Sport automatically selects gas 1.

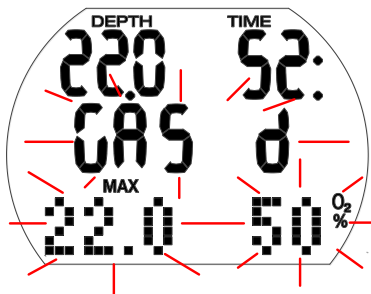

## ⚠ WARNING

When during an ascent a switch depth is reached (MOD gas 2 or gas d), an audible warning sounds and “GAS 2”/“GAS d”, its MOD and  $O_2\%$  blink for 30 seconds.

Procedure:

- Switch to the regulator with gas 2/gas d and start breathing.
- Confirm the change with a press-and-hold of the right button within 30 seconds. “GAS 2”/“GAS d” and the oxygen fraction of gas 2/gas d is displayed for 5 seconds without blinking.

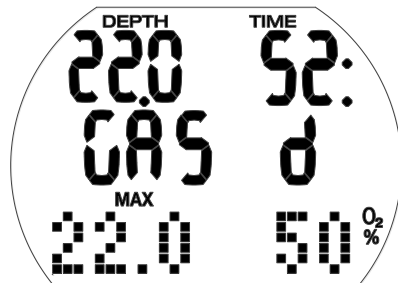

To interrupt the switch process at any point, either press the right button until the original gas is again active, or do not confirm the gas change process.

### No change of gas mixture:

If you fail to confirm the change of gas mixture or if you interrupt the switching procedure by pressing the right button, the Aladin Sport displays “GAS 1”/“GAS 2”, the MOD and the oxygen fraction for 5 seconds. The Aladin Sport continues to calculate with gas 1/gas 2 only and adapts the decompression calculation accordingly.

☞ **NOTE:** After the decompression calculation has readjusted itself to reflect a failed switch, if you once again exceed the switch depth (MOD of gas 2/gas d) the Aladin Sport will revert to the decompression calculation that considers gas 2/gas d also, since upon ascending again you will have a renewed opportunity to perform the switch once the switch depth is reached.

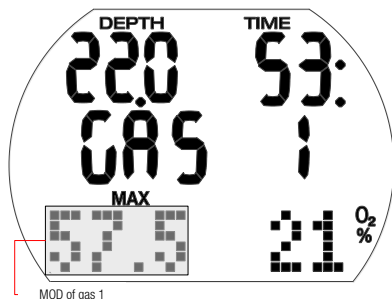

### Belated or manual change of gas mixture:

You can catch up on a required change to gas 2/gas d until you reach the surface.

Procedure:

1. Initiate the switching process by pressing and holding the right button. The Aladin Sport displays "GAS 2" / "GAS d", MOD and the oxygen fraction of gas 2/gas d blinking for 30 seconds. By pressing the right button you can select "GAS 2", "GAS d" or "GAS 1".
2. Switch to the regulator with the selected gas mixture and start breathing.
3. Confirm the change with a press-and-hold of the right button. "GAS 2", "GAS d" or "GAS 1" and its oxygen fraction is displayed for 5 seconds without blinking. The decompression calculation will readjust accordingly.

### Submerging again after a change to gas 2/gas d:

If, after a change to gas 2/gas d the Maximum Operating Depth (MOD) of gas 2/gas d is exceeded, the ppO<sub>2</sub> max warning will appear. If this happens, switch back to gas 1 or ascend to the MOD of gas 2/gas d. Failure to do so can result in oxygen poisoning.

Procedure:

1. Initiate the switching process with a press-and-hold of the right button. The Aladin Sport displays "GAS 1"/"GAS 2", MOD and the oxygen fraction of gas 1/gas 2 for 30 seconds.
2. By pressing the right button you can select "GAS 2", "GAS 1" or "GAS d".
3. Switch to the regulator with the selected gas and start breathing.

4. Confirm the change with a press-and-hold of the right button. "GAS 1" / "GAS 2" / "GAS d" and its oxygen fraction is displayed for 5 seconds without blinking. Afterwards the decompression calculation will readjust accordingly.

## 4. FUNCTIONS ON THE SURFACE

### 4.1 COMPASS

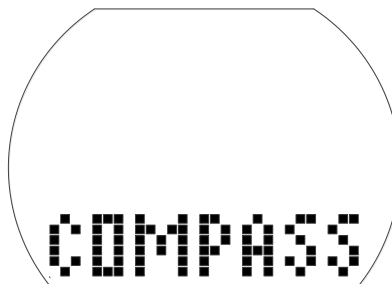
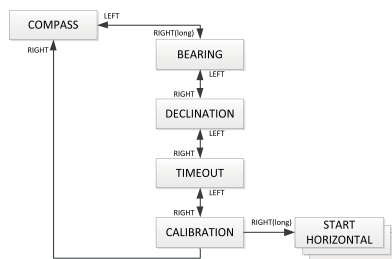

#### 4.1.1 Finding a direction

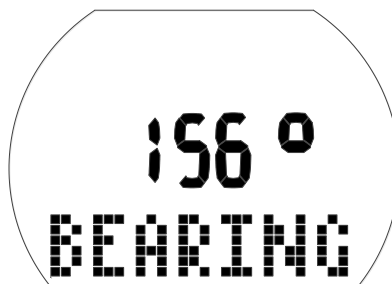

To use your compass:

- Starting from the time of day display push the left or right button to get to the compass screen, then press-and-hold the right button.

- This activates the compass function. It now shows BEARING in the matrix display below the actual bearing, which is shown in degrees.
- Another press-and-hold of the right button shows the bearing direction (12 o'clock on the display) indicated by an "∧" in the matrix display below the actual bearing, which is shown in degrees.

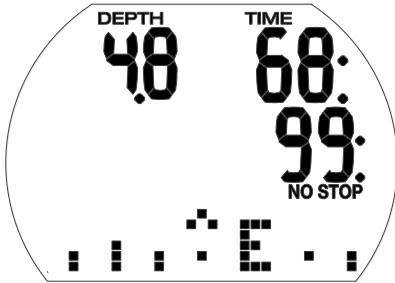

☞ **NOTE:** During a dive the compass bearing is shown as a compass rose in the matrix display with main directions N (North), E (East), S (South), W (West).

#### 4.1.2 Setting declination

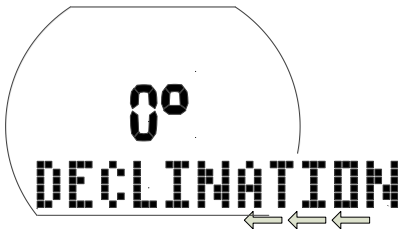

A compass points to the magnetic north pole of the earth. Differences between geographic and magnetic north poles are corrected with a declination setting. Declination depends on your current location on the earth.

To set declination:

- Starting from the time of day display, push the left or right button to get to the compass screen, then press-and-hold the right button.
- Press the right button 1x to get to the declination settings screen, then press-and-hold the right button.
- Press the left or right button to select the

degree of declination for your geographic area (ranging from -90 to 90 degrees), then confirm your selection with a press-and-hold of the right button.

- Press-and-hold both left and right buttons simultaneously to return to the time of day display.

#### 4.1.3 Setting timeout





Compass timeout is the amount of time the compass is displayed when activated during diving.

To set your compass timeout:

- Starting from the time of day display, push the left or right button to get to the compass screen, then press-and-hold the right button.
- Press the right button 2x to get to the timeout setting screen, then press-and-hold the right button.
- Press the left or right button to choose the length of time you'd like the compass screen displayed. Choices are 5, 10, 15, 30 and 60 seconds, or push on/push off.
- Confirm your choice with a press-and-hold of the right button.
- Press-and-hold both left and right buttons simultaneously to return to the time of day display.

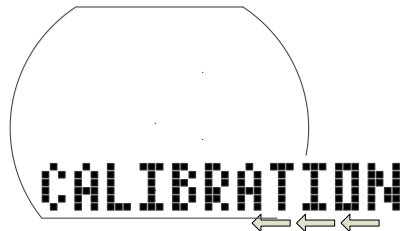
#### 4.1.4 Recalibrating the compass



 **NOTE:** Before using the compass you must first calibrate it to your geographic location. (It must also be recalibrated after each battery change or when traveling to another location where the earth's magnetic field strength is different.)

To calibrate or recalibrate your compass:

- Starting from the time of day display, push the left or right button to get to the compass screen, then press-and-hold the right button.
- Press the right button 3x to get to the calibration screen, then press-and-hold the right button.

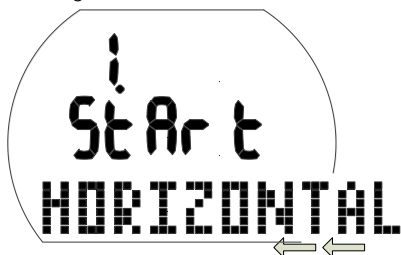

- Position the Aladin Sport with its display facing up. Press-and-hold the right button.

 **NOTE:** Best results are reached by rotating Aladin Sport precisely at a one (horizontal) plane.

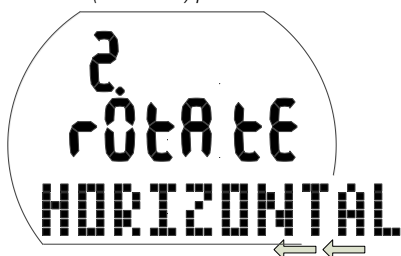

- Rotate the Aladin Sport at least 360° horizontally. Press-and-hold the right button.

 **NOTE:** Best results are reached by rotating the Aladin Sport slowly.

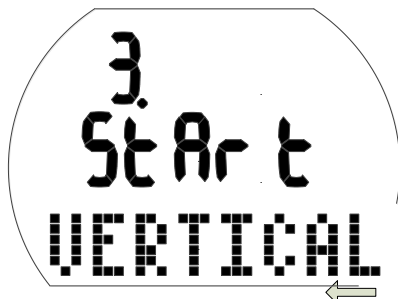

- Position the Aladin Sport with its display facing sideways. Press-and-hold the right button.

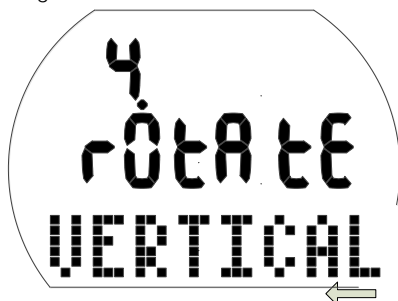

- Rotate the Aladin Sport at least 360° horizontally. Press-and-hold the right button.

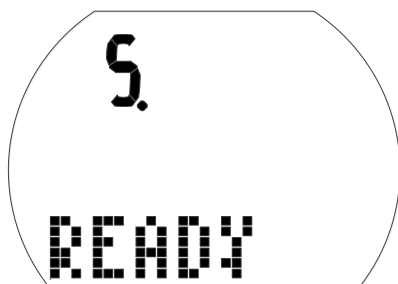

- The compass calibration is now complete.
- Press-and-hold both left and right buttons simultaneously to return to the time of day display.

## 4.2 DIVE PLANNER

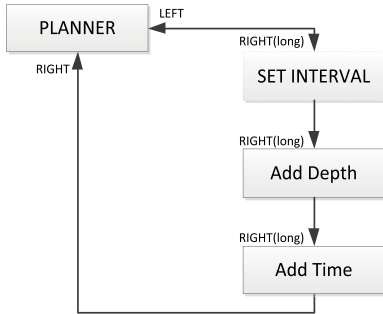

The Aladin Sport has a dive planner which allows the planning of no-stop dives and decompression dives. The following elements are included as the basis for dive planning:

- Selected fraction of oxygen and MOD.
- Selected water type.
- Selected MB level.
- Water temperature of the most recent dive.
- Altitude class (if any).
- Status of saturation at the time the dive planner is selected.
- Assumption: a normal diver workload and observance of the prescribed ascent rates.
- Assumption: the change to gas 2/gas d is performed at the selected MOD of gas 2/gas d.

### 4.2.1 Planning a no-stop dive

To select the dive planner the Aladin Sport must start in the time of day display.

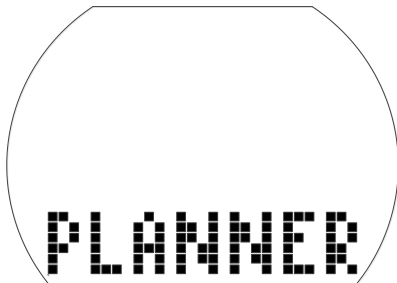

- Push the left or right button until the symbol for the dive planner appears. (The dive planner cannot be selected

in gauge mode.) Enter the dive planner with a press-and-hold of the right button.

- The input window for the time interval is displayed if any desaturation (DESAT) remains before selecting the dive planner. This surface interval, timed between now and the beginning of the planned dive, can be changed in increments of 15 minutes by pressing the left or right button.
- The Aladin Sport displays the CNS O<sub>2</sub>% value and the altitude class to which you may not rise at the end of the selected surface interval.



- If the no-dive warning\* and its duration has been displayed, the Aladin Sport proposes this time – rounded up to the next 15 minutes – as surface interval. If the proposed interval is shortened, the no-dive warning\* appears.





- Confirm the displayed interval (if applicable) with a press-and-hold of the right button. If no desaturation is remaining, the original press-and-hold from the PLANNER screen takes you directly to depth/no-stop planning:
- Pushing the left or right button selects

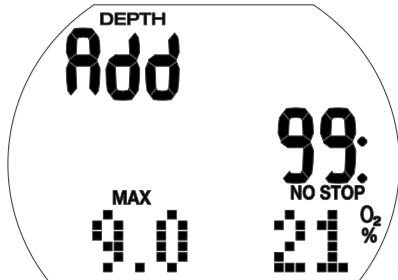

the depth and the no-stop time for that depth.

- If a MB level has been selected (L1-L5), the MB no-stop time is shown.
- Depths deeper than the MOD for the selected gas (O<sub>2</sub> mix) are not displayed.
- If the deco gas option is turned on, only the depth between the MOD of gas 1 and the MOD of gas 2 are displayed.



 **NOTE:** The no-dive warning and its duration are displayed if the Aladin Sport detects an increased risk due to the accumulation of microbubbles.

\* For more information and safety considerations regarding the no-dive warning, see chapter: **Diving with your Aladin Sport**, section: **Desaturation time, No-fly time and No-dive warning**.

#### 4.2.2 Planning a decompression dive

1. Activate the dive planner.
2. Set the desired depth by pressing the left or right button and then confirming with a press-and-hold of the right button. The Aladin Sport shows the bottom time (no-stop time + 1 minute) and the appropriate decompression information or level stop data, respectively.
3. "Add" asks that you set the bottom time. This is done by pressing the left or right button. The Aladin Sport calculates the decompression information for this set bottom time. If a MB level (L1-5) is selected, the Aladin Sport calculates the level stop data.

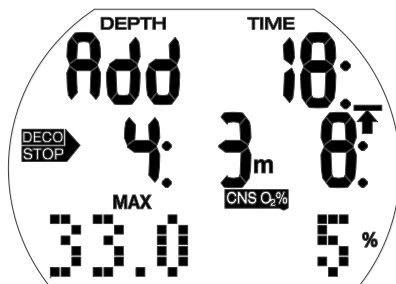

CNS O<sub>2</sub>% values higher than 199% will be displayed as 199%.

Ascent time greater than 99 minutes is displayed as "--".

Deco stop depth deeper than 27m/90ft is displayed as "--:--".

CNS O<sub>2</sub> equal or greater than 75%: CNS O<sub>2</sub>% symbol starts flashing.

CNS O<sub>2</sub> equal or greater than 100%: CNS O<sub>2</sub>% symbol and CNS O<sub>2</sub>% value are flashing.

MB level stop deeper than 27m/90ft: MB level will be reduced.

#### 4.2.3 Leaving the dive planner

By pressing-and-holding the right button at the time field you can exit the dive planner. This will also occur after 3 minutes without operation.

## 4.3 LOGBOOK

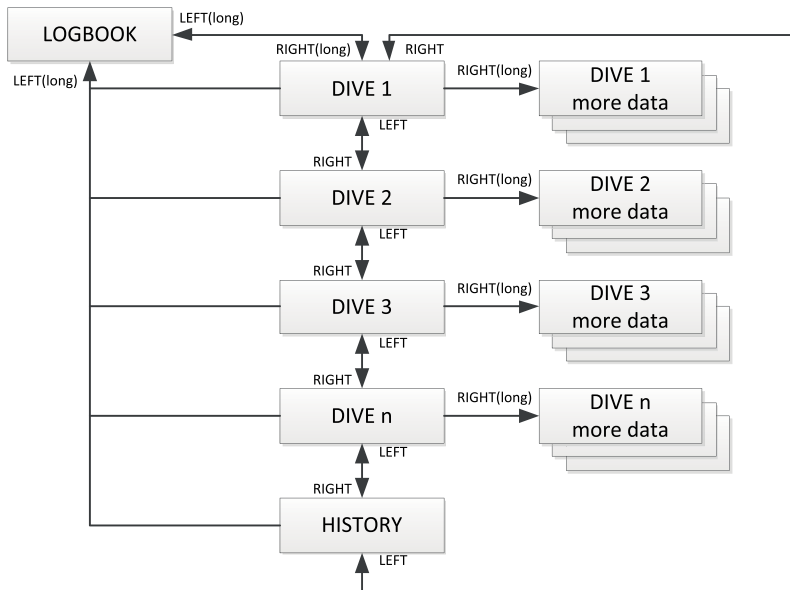

### 4.3.1 Survey

A dive is entered in the logbook if the dive time is longer than 2 minutes. The Aladin Sport records the profiles of about 25 hours of diving. In apnea mode all dives are entered in the logbook without a time limit and at least 6 hours of apnea profiles will be stored.

This information can be transferred to a PC with the Bluetooth interface and LogTRAK. All dives in the memory can be displayed directly on the dive computer.

### 4.3.2 Operation

From the time of day display you can select the logbook by pressing the left or right button until the following logbook menu appears:

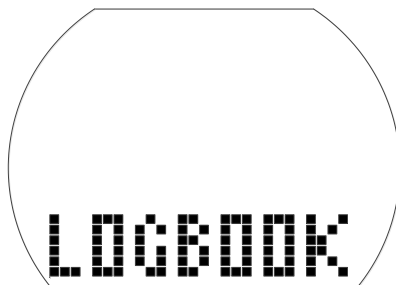

- With a press-and-hold of the right button you enter the logbook.
- By pressing the left or right button you can scroll through the different logged dives, which are numbered 1, 2, 3, etc., with the most recent dive shown as dive number 1.
- Primary information from each dive (max depth, dive time, date) is shown on page 1 of the log. More information on the dive are shown on page 2 and page 3.
- From page 1, page 2 can be accessed by a press-and-hold of the right button.

- From page 2, page 3 can be accessed by pressing the right button.
- Press again the right button to return on page 1.

#### 4.3.2.1 Page 1

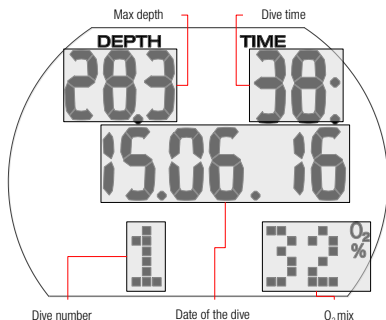

**NOTE:** Single apnea dives are generally shorter and repeated with shorter surface intervals. They are stored in dive sessions which contains several single dives. As long as the surface interval is shorter than 15 minutes, the dives are included in the same session.

#### 4.3.2.2 Page 2

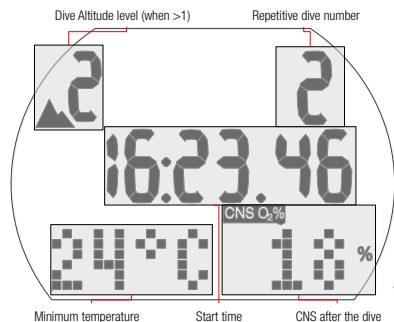

Apnea sessions have different information on page 2 and on the following pages (each following page includes a single dive):

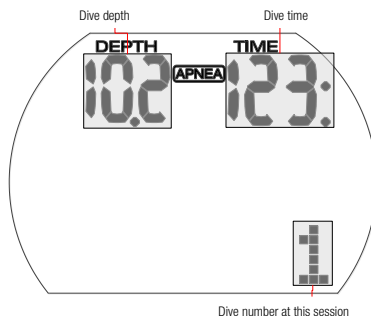

#### 4.3.2.3 Page 3

If a dive is started within adaptation time (after a change of altitude), the adaptation time is displayed instead of the surface interval.

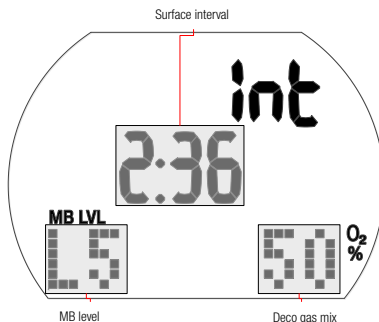

Further possible information about the dive:  
Too fast ascent\* (page 1).

**STOP DECO** Ignored decompression stop\* (page 1).

Diving in SOS mode (gauge mode) (page 3).

Altitude class (page 2).

MB level dive (L1-L5) (page 3).

**STOP** Ignored MB level stop\* (page 1).

DESAT Desaturation was reset before the dive (in USER menu) (page 1, 2).

Battery quality factor has been 3 bars or less during the dive (page 1, 2, 3).

Diving in gauge mode (page 1, 2, 3).

AVG Average depth (gauge mode) (page 3).

No-dive warning after the dive (page 1).

Apnea mode dive (all pages)

Page 3: gas 2 mix (t2)

Page 4: gas d mix (td)

\*Alarms during the dive.

Pushing the right button gets you back to the dive list (first level screen within logbook). From here you can advance to the next dive of interest by pushing the right button, and then a press-and-hold of the right button lets you retrieve more information about that dive, etc.

#### 4.3.2.4 Statistical information (HISTORY)

The history page is located between the last and first log in the round-robin list of dives.

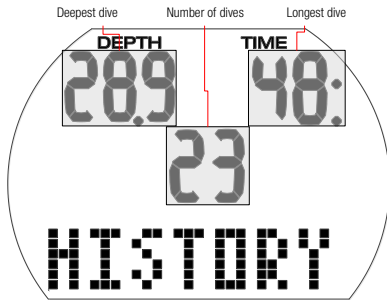

#### Leaving the logbook

By pushing-and-holding the left button you can exit the logbook. The logbook will also close automatically after 3 minutes without operation.

## 5. SETTINGS

### 5.1 Altitude adjustment

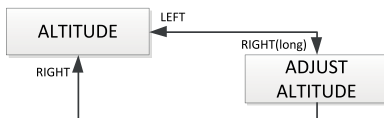

The altitude adjustment does not affect altitude class or calculations. To adjust the altitude indicator to your current altitude:

1. Starting from the time of day display, push the left or right button to get you to the altitude screen.
2. Confirm that you wish to change the displayed altitude with a press-and-hold of the right button. The altitude starts to flash.
3. Change the altitude in increments of 10m/50ft by pushing either the left or right button.
4. Confirm the selected altitude with a press-and-hold of the right button.

## 5.2 Dive menu

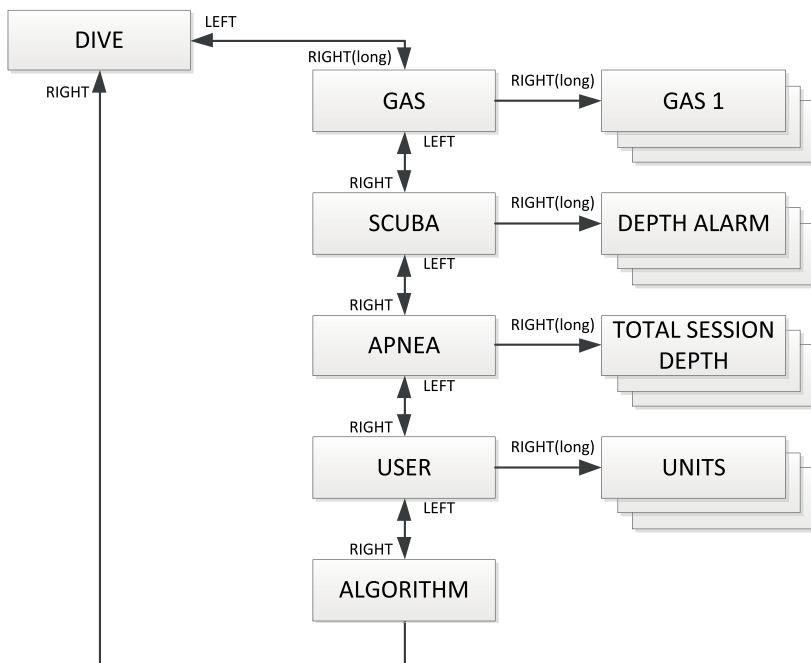

With the dive display menu or with LogTRAK you can configure the following items:

### Setting Range; Default Setting

- Depth alarm: 5-100m/20-330ft, on/off; 40m/130ft, off.
- Dive time alarm: 5-195min, on/off; 60min, off.
- Safety stop duration: 1-5min; 3min.
- Maximum partial pressure of oxygen (ppO<sub>2</sub> max): 1.0 - 1.6bar; OFF; 1.4bar.
- Time limit to reset the O<sub>2</sub>% mix to air: no reset/1-48hrs; no reset.
- PDIS (Profile Dependent Intermediate Stop): on/off; off.
- Unit system: metric/imperial; no default.
- Water type: on (salt water)/off (fresh water); on (salt water).
- Backlight illumination duration: 2-12secs or push on/push off; 10secs.
- Audible attention signals: on/off (LogTRAK: selective); on.

- Reset desaturation: on/off; no reset.
- MB-Level: 0-5; 0.

Starting from the time of day display, press the left or right button until dive display is shown:



Enter the dive display menu with a press-and-hold of the right button.

Once entered you can scroll through the menu by pressing the left or right button.

### 5.2.1 Gas menu

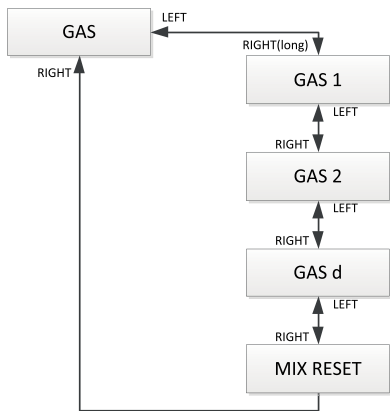

In the gas menu you can change different nitrox mix settings or enable multi-gas functions.

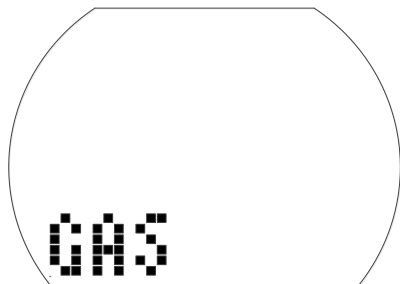

#### Setting the GAS 1

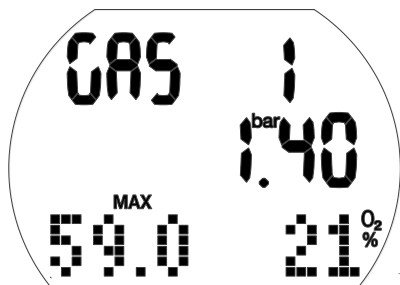

1. Confirm that you wish to change the GAS 1 content with a press-and-hold of the right button.  
Gas nitrox value (O<sub>2</sub>%) starts to flash.
2. Press the left or right button to increase/decrease in 1% increments.

3. Confirm content with a press-and-hold of the right button.
- The ppO<sub>2</sub> values.
4. Change the ppO<sub>2</sub> value in increments of 0.05bar by pressing the right button.
5. Confirm the value with a press-and-hold of the right button.

#### Setting the GAS 2



1. Confirm that you wish to change the GAS 2 content with a press-and-hold of the right button.  
Gas nitrox value (O<sub>2</sub>%) starts to flash.
2. Press the left or right button to increase/decrease in 1% increments.
3. Confirm content with a press-and-hold of the right button.  
The ppO<sub>2</sub> values.
4. Change the ppO<sub>2</sub> value in increments of 0.05bar by pressing the right button.
5. Confirm the value with a press-and-hold of the right button.

**NOTE:** Gas d has to be set before gas 2 can be enabled.

#### Setting the GAS d



1. Confirm that you wish to change the GAS d content with a press-and-hold of the right button.  
Gas nitrox value (O<sub>2</sub>%) starts to flash.

2. Press the left or right button to increase/decrease in 1% increments.
  3. Confirm content with a press-and-hold of the right button.
- The  $ppO_2$  values.
4. Change the  $ppO_2$  value in increments of 0.05bar by pressing the right button.
  5. Confirm the value with a press-and-hold of the right button.



**NOTE:** When the gas nitrox value is between 80..100%, the  $ppO_2$  is automatic 1.60bar and cannot be edited.

### Setting the nitrox reset time

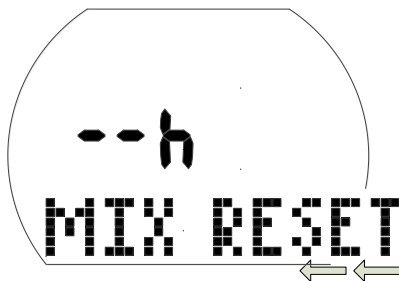

### Setting the time limit to reset the $O_2\%$ mix to air

1. Confirm that you wish to change the time limit of the reset with a press-and-hold of the right button. The current setting starts to flash.
2. Change the time limit by pushing the left or right button (1- 48hrs or no reset: "-- h").
3. Confirm the selected value with a press-and-hold of the right button.

## 5.2.2 Scuba menu

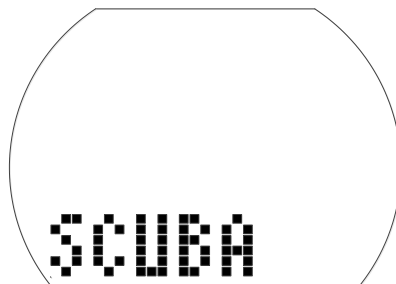
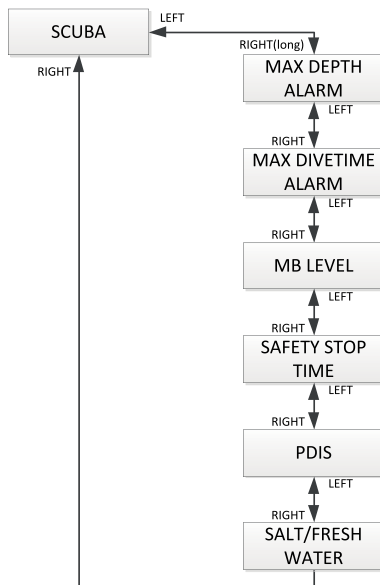

In the scuba menu you can change different alarms and settings for the dive.

### Setting the depth alarm

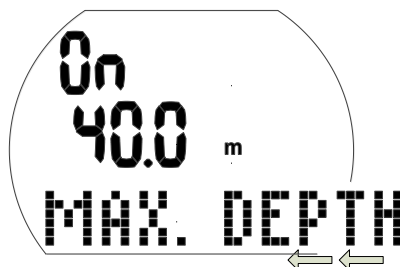

1. Confirm that you wish to change the depth of the warning, or switch it on or off, with a press-and-hold of the right button.

“On” or “Off” starts to flash. “On” indicates “activated”, “Off” indicates “deactivated”.

2. Press the left or right button to switch between “On” and “Off”.
3. Confirm the selected status with a press-and-hold of the right button.

The depth starts to flash.

4. Change the warning depth in increments of 1m/5ft by pressing the right button.
5. Confirm the warning settings with a press-and-hold of the right button.

### Setting the dive time alarm

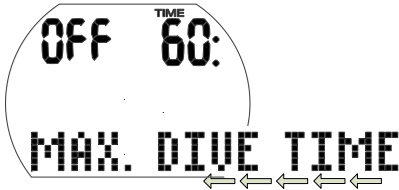

1. Confirm that you wish to change the time of the dive time warning, or switch it on or off, with a press-and-hold of the right button.

“On” or “Off” starts to flash. “On” indicates “activated”, “Off” indicates “deactivated”.

2. Switch between “On” or “Off” by pressing the left or right button.
3. Confirm the selected status with a press-and-hold of the right button. The alarm time starts to flash.
4. Change the warning time in increments of 5 minutes by pressing the right button.
5. Confirm the warning settings with a press-and-hold of the right button.

### Setting the MB Level

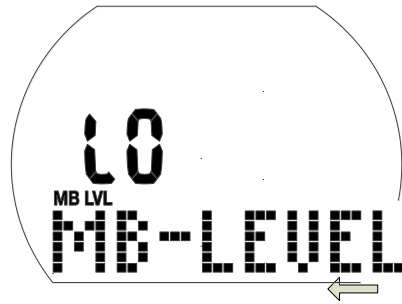

1. Confirm that you wish to change the MB level setting with a press-and-hold of the right button.

The value L0..L5 starts to flash.

2. Change the MB level by pressing the left or right button.
3. Confirm the selected MB level with a press-and-hold of the right button.

### Setting the safety stop duration

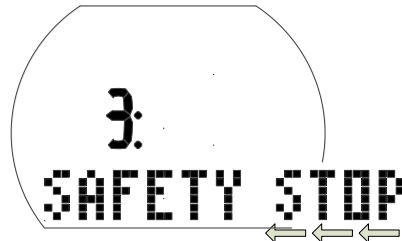

1. Confirm that you wish to change the duration of the safety stop with a press-and-hold of the right button.

The duration starts to flash.

2. Change the duration in increments of 1 minute by pressing the left or right button.
3. Confirm the selected duration with a press-and-hold of the right button.

### Setting PDIS

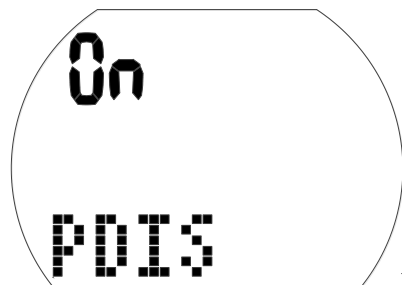



### PDIS (Profile Dependent Intermediate Stop)

1. Confirm that you wish to enable PDIS with a press-and-hold of the right button.  
“On” or “Off” starts to flash. “On” indicates that the PDIS timer will be automatically activated during the dive, “Off” indicates that PDIS will be inactive.
2. Switch between “On” and “Off” by pressing the left or right button.
3. Confirm your choice with a press-and-hold of the right button.

#### Selecting water type



#### Selecting the water type

1. Confirm that you wish to change the selected water type with a press-and-hold of the right button.  
“On” or “Off” starts to flash. “On” indicates salt water, “Off” indicates fresh water.
2. Switch between “On” and “Off” by pressing the left or right button.
3. Confirm the water type with a press-and-hold of the right button.

 **NOTE:** Water type has an effect on displayed depth. Roughly, 1bar/14.5psi water pressure corresponds to 10m/33ft depth in salt water and 10.3m/34ft depth in fresh water.

### 5.2.3 User menu

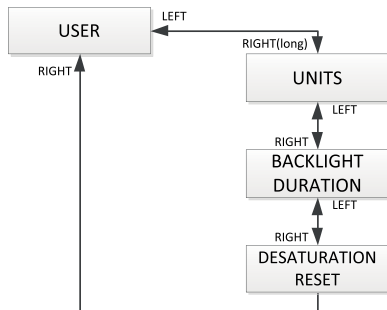

#### Selecting the units

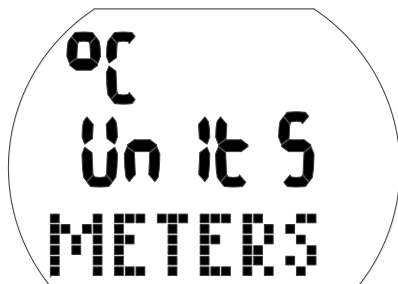

1. Confirm that you wish to change the units with a press-and-hold of the right button.  
“°C” or “°F” starts to flash.
2. Switch between “°C” and “°F” by pressing the left or right button.
3. Confirm the selected unit with a press-and-hold of the right button.  
Meters or Feet start to flash.
4. Switch between meters or feet by pressing the left or right button.
5. Confirm the selected unit with a press-and-hold of the right button.

#### Setting the backlight duration

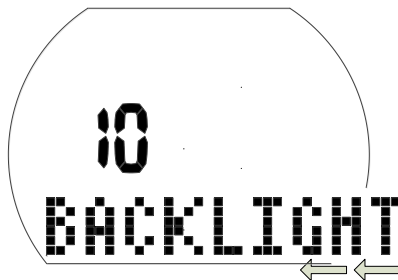

1. Confirm that you wish to change the duration of the backlight illumination with a press-and-hold of the right button.  
The value starts to flash (2-12secs or push on/push off).
2. Change the duration by pressing the left or right button.
3. Confirm the selection with a press-and-hold of the right button.

### Resetting the remaining saturation

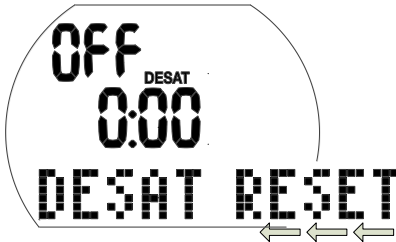

#### ⚠ WARNING

- Diving after a reset of the remaining saturation may lead you into potentially hazardous situations which could result in death or serious injury. After a reset of the remaining saturation do not dive for at least 48 hours.
- If you dive after resetting the remaining saturation the computer will miscalculate your decompression, which may result in serious injury or death. Reset the remaining saturation only if you know you will not be diving, flying or going to higher altitude for the next 48 hours.
- Resetting the desaturation should only be done when there is a valid reason, e.g. loaning the computer to somebody who has not dived in 48 hours or more. When the computer itself has remaining saturation you must assume full responsibility for the consequences of resetting the remaining saturation.

1. Confirm that you wish to reset the displayed saturation with a press-and-hold of the right button.  
"On" starts to flash.
2. Switch between "On" or "Off" by pressing the left or right button.
3. Confirm the setting with a press-and-hold of the right button.

- If you have selected "Off", "Code" and "000" appear.
4. Set the first digit by pressing the left or right button. Confirm with a press-and-hold of the right button.
  5. Repeat Step 4 for the next 2 digits.  
If you entered the right code the desaturation will be reset to zero (desat off). Code: 313.

### 5.3 Watch menu

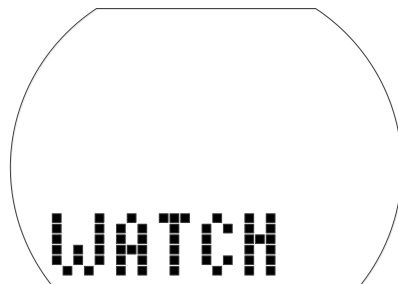
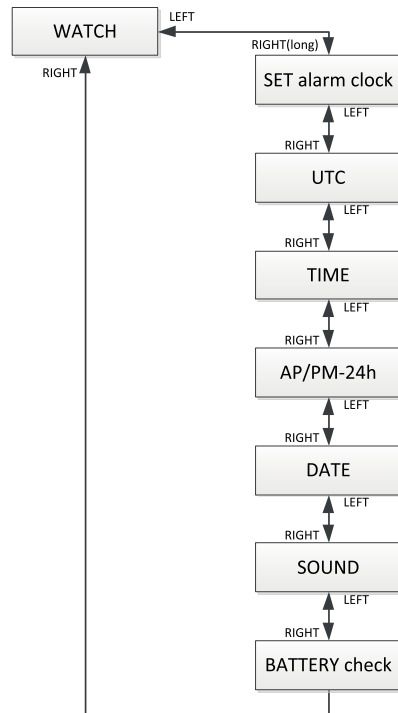

Using the watch menu or LogTRAK you can configure the following items:

Setting	Range	Default
Alarm clock		off
UTC (Universal Time Coordinated) zone	-13/+14hrs, increments: 15min	
24h or AM/PM setting		24h
Date		
Silent mode	On, warnings, alarms, off	on
Check the battery state		

1. Starting from the time of day display, press the left or right button until "WATCH" appears.
2. Confirm that you wish to enter into the watch menu with a press-and-hold of the right button.
3. Once entered you can scroll through the menu by pressing the left or right button.

### 5.3.1 Setting the alarm clock time



The alarm clock tone works only at the surface.

1. Confirm that you wish to set the alarm time with a press-and-hold of the right button.  
"On" (activated) or "Off" (deactivated) starts to flash.
2. Switch between "On" and "Off" by pressing the left or right button.
3. Confirm the selected status with a press-and-hold of the right button.  
The hours start to flash.

4. Set the hours by pressing the left or right button.
5. Confirm the setting with a press-and-hold of the right button.  
The minutes start to flash.
6. Set the minutes by pressing the left or right button.
7. Confirm the setting with a press-and-hold of the right button.

### 5.3.2 Setting the UTC offset (coordinated universal time)



This setting allows you to quickly set the watch to a new time zone without affecting the actual time setting.

1. Confirm that you wish to set the UTC offset with a press-and-hold of the right button.  
The hours start to flash.
2. Set the hours by pressing the left or right button (-13/+14hrs).
3. Confirm the setting with a press-and-hold of the right button.  
The minutes start to flash.
4. Set the minutes in increments of 15 minutes by pressing the left or right button.
5. Confirm the selected status with a press-and-hold of the right button.

### 5.3.3 Adjusting the time of day



You can adjust the Aladin Sport to your time zone either in this menu or using the UTC offset (see above).

1. Confirm that you wish to adjust the time of day with a press-and-hold of the right button.  
The hours start to flash.
2. Set the hours by pressing the left or right button.
3. Confirm the setting with a press-and-hold of the right button.  
The minutes start to flash.
4. Set the minutes by pressing the left or right button.
5. Confirm the setting with a press-and-hold of the right button.

### 5.3.4 Selecting 24-hour or AM/PM setting

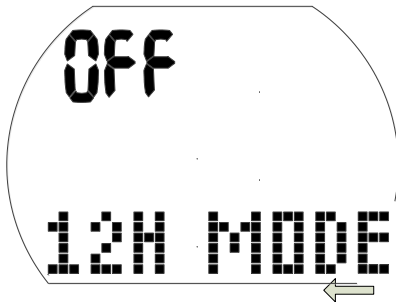

1. Confirm that you wish to change the setting with a press-and-hold of the right button.  
"On" or "Off" starts to flash.
2. Switch between "On" (AM/PM) and "Off" (24h) by pressing the left or right button.
3. Confirm the setting with a press-and-hold of the right button.

The 24h - AM/PM setting influences the display of the date (see below).

### 5.3.5 Adjusting the date

Date: Day/Month/Year (24h setting)



Date: Month/Day/Year (AP/PM setting)



1. Confirm that you wish to adjust the date with a press-and-hold of the right button.  
The day (or month) starts to flash.
2. Set the day (or month) by pressing the left or right button.
3. Confirm the setting with a press-and-hold of the right button.  
The month (or day) starts to flash.
4. Set the month (or day) by pressing the left or right button.
5. Confirm the setting with a press-and-hold of the right button.  
The year starts to flash.
6. Set the year by pressing the left or right button.
7. Confirm the setting with a press-and-hold of the right button.

### 5.3.6 Switching the sound on and off

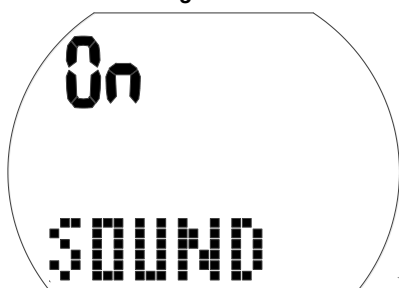

#### WARNING

If you turn off the sound, the buzzer is effectively deactivated. You will have no audible warnings (alarms and attention messages). Without audible warnings you could get into potentially hazardous situations, which could result in death or serious injury. You must assume full responsibility for turning off the sound.

1. Confirm that you wish to change the setting with a press-and-hold of the right button.  
"On", "Off", "Alr" or "Att" starts to flash. The "On" setting has all audible tones activated, including the button-pressing tone.  
The "Off" setting is the silent mode, without any tones, except the alarm clock.  
The "Alr" setting has alarm tones activated.  
The "Att" setting has alarm and attention tones activated.
2. Switch between selections by pressing the left or right button.
3. Confirm the setting with a press-and-hold of the right button.  
If you have selected "Off", "Code" and "000" appear.
4. Set the first digit by pressing the left or right button. Confirm with a press-and-hold of the right button.
5. Repeat Step 4 for the next 2 digits. If you entered the right code the sound will be turned off. The Code: 313

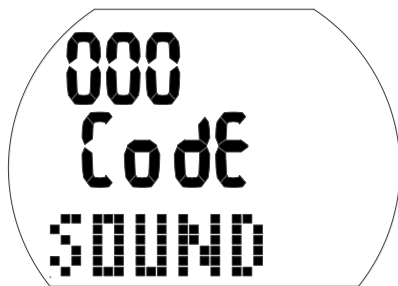

 NOTE: Setting the sound to "off" applies also to surface functions (altitude alarm and change of altitude class).

### 5.3.7 Check the battery status

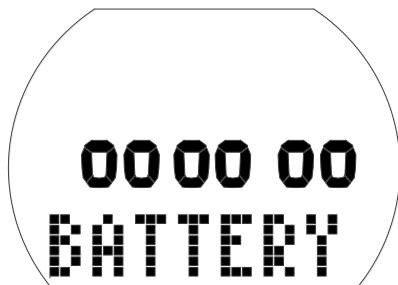

Battery status is shown in this menu. A fresh battery is indicated by 6 zeros, whereas a used battery is indicated by fewer zeros, as in below:

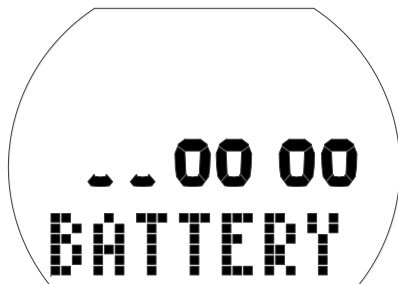

To learn more about battery status, see chapter: **System and Operation**, section: **Checking the battery condition**.

## 5.4 Apnea menu

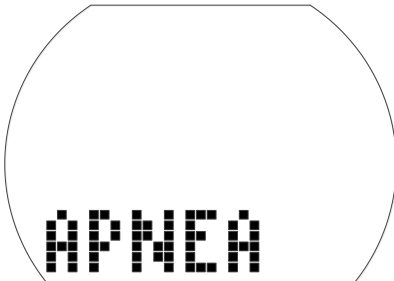
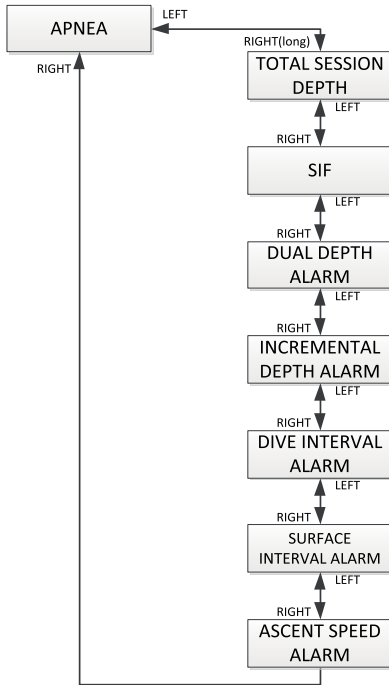

With the Apnea menu or LogTRAK you can configure the following items:

Setting	Range	Default
Total Session Depth	100..1000m, off	off
SIF (Surface Interval Factor)	5..20, off	off
Dual Depth Alarm	5-100m, 5-100m, on/off	off
Depth Incremental Alarm	5-100m, dn(down)/up/ bth(both)/off	off
Dive Interval Alarm	15s-10min, on/off	off
Surface Interval Alarm	15s-10min, on/off	off
Ascent Speed Alarm	0.1-5 m/s (1-15 ft/s), on/off	off

1. Starting from the dive display, press-and-hold the right button, then push the right button until "APNEA" appears.
2. Confirm that you wish to enter the apnea menu with a press-and-hold of the right button.
3. Once entered you can scroll through the menu by pressing the left or right button.

### 5.4.1 Setting the total session depth

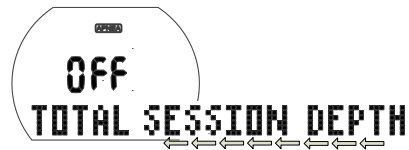

You can set a total session depth (cumulative value) with this alarm.

1. Confirm that you wish to change the settings of the total session depth alarm with a press-and-hold of the right button. "Off" or the selected value starts to flash.
2. Scroll through the values by pressing the left or right button.
3. Confirm the selected value increment with a press-and-hold of the right button.

#### 5.4.2 Setting the surface interval factor (SIF)



You can set a surface interval factor value with this alarm.

1. Confirm that you wish to change the settings of the surface interval factor with a press-and-hold of the right button.  
"Off" (deactivated) or a value between 5..20 starts to flash.
2. Scroll through the values by pressing the left or right button.
3. Confirm the selected value increment with a press-and-hold of the right button.

#### 5.4.3 Setting the dual depth alarm

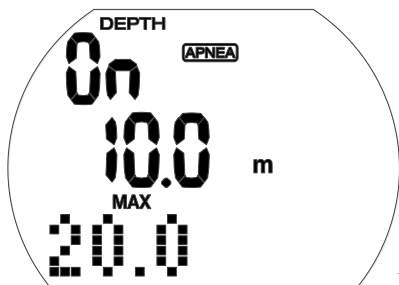

With this alarm you can set two independent depth alarms.

1. Confirm that you wish to change the settings of the dual depth alarm with a press-and-hold of the right button.  
"On" or "Off" starts to flash.
2. Switch between on/off by pressing the left or right button.
3. Confirm the setting with a press-and-hold of the right button.  
The first depth value starts to flash.

4. Scroll the first depth by pressing the left or right button.
5. Confirm the first depth alarm with a press-and-hold of the right button.  
The second depth alarm starts to flash.
6. Scroll the second depth by pressing the left or right button.
7. Confirm the setting with a press-and-hold of the right button.

#### 5.4.4 Setting the incremental depth alarm

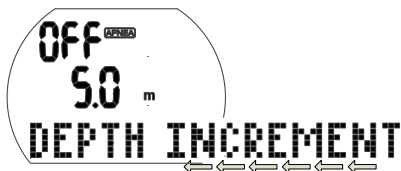

You can set the repetitive depth alarm with given depth increments with this alarm.

1. Confirm that you wish to change the settings of the incremental depth alarm with a press-and-hold of the right button.  
"Up" (up), "Dn" (down), "Bth" (both) or "Off" starts to flash.
2. Switch between Up/Down/Both/Off by pressing the left or right button.
3. Confirm the setting with a press-and-hold of the right button.  
The incremental value starts to flash.
4. Scroll the incremental values by pressing the left or right button.
5. Confirm the selected increment with a press-and-hold of the right button.

#### 5.4.5 Setting the dive time interval alarm

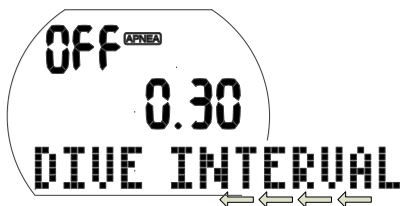

You can set dive time that repeats on given intervals with this alarm.

1. Confirm that you wish to change the settings of the dive time interval warning with a press-and-hold of the right button.

- “On” or “Off” starts to flash.
- 2. Switch between on/off by pressing the left or right button.
- 3. Confirm the setting with a press-and-hold of the right button.  
The interval value starts to flash.
- 4. Scroll through the time values by pressing the left or right button.
- 5. Confirm the selected interval time with a press-and-hold of the right button.

#### 5.4.6 Setting the surface interval alarm



With this alarm you can set a time for recovery or a start time for a repetitive dive when training against given tables.

- 1. Confirm that you wish to change the settings of the surface interval warning with a press-and-hold of the right button.  
“On” or “Off” starts to flash.
- 2. Switch between on/off by pressing the left or right button.
- 3. Confirm the setting with a press-and-hold of the right button.  
The time value starts to flash.
- 4. Scroll the time values by pressing the left or right button.
- 5. Confirm the selected surface time with a press-and-hold of the right button.

#### 5.4.7 Setting the ascent speed alarm

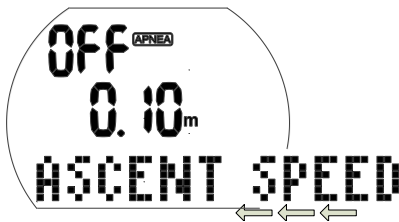

Ascent speed can be set with this alarm.

- 1. Confirm that you wish to change the settings of the ascent speed alarm with a press-and-hold of the right button.  
“On” or “Off” starts to flash.

- 2. Switch between on/off by pressing the left or right button.
- 3. Confirm the setting with a press-and-hold of the right button.  
The time value starts to flash.
- 4. Scroll the ascent speed values by pressing the left or right button.
- 5. Confirm the selected maximum ascent speed with a press-and-hold of the right button.

## 6. INTERFACING WITH WINDOWS/MAC AND APPS

### 6.1 Introduction to SCUBAPRO LogTRAK

LogTRAK is the software that allows the Aladin Sport to communicate with a Windows-based PC, a Mac, Android devices or Apple devices.

In order to take advantage of any of these features, you need to establish a communication between your PC and your Aladin Sport with a Bluetooth connection.

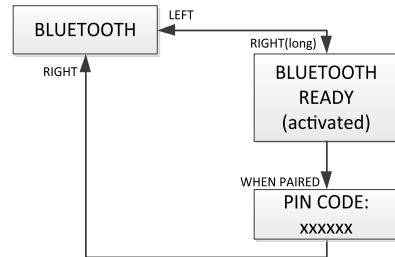

To start the communication:

- 1. If your PC/Mac has Bluetooth, enable it.
  - a. If your PC/Mac doesn't have a Bluetooth Low Energy (BLE), connect the suitable dongle to your PC/Mac.
- 2. Launch LogTRAK on your PC/Mac.
  - a. Select the Bluetooth.  
(Extras > Options > Download)  
Select the Bluetooth option.
- 3. Switch on the Aladin Sport.
- 4. Press the right button to get to the Bluetooth menu.



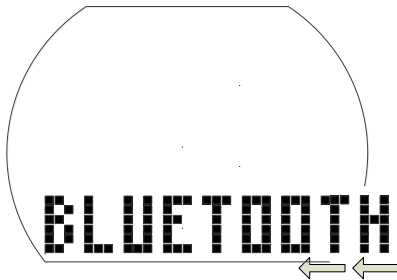

1. Press-and-hold the right button to activate Bluetooth advertising.

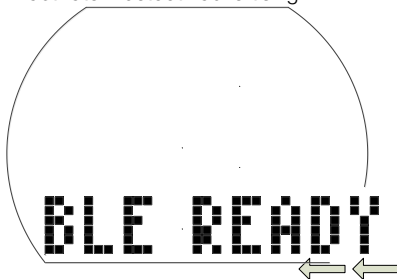

2. When a connection between your PC/Mac and Aladin Sport is established, the Aladin Sport will provide a 6-digit pin code.

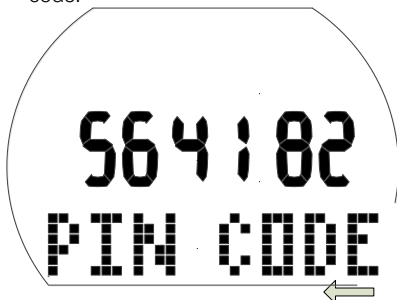

3. Give this code to your PC/Mac. Connection between both devices is ready.



### Download dive profiles

From LogTRAK, by selecting Dive > Download Dives you can transfer the Aladin Sport logbook to your PC/Mac.

There are three main views, each showing a specific part of your dive log:

**Profile** shows the graphical data of the dive.



**Details** about the dive, where you can edit, for example, the equipment and tank information.



**Location** shows your dive site on the world map.

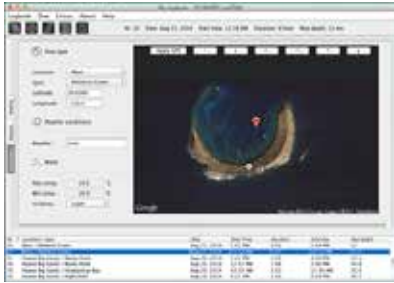

The selection tabs for views are on the left side of the main window.

## 6.2 Changing warnings/ settings of the Aladin Sport and reading computer information

By selecting Extras > Read Dive Computer settings you can enable/disable warnings that cannot be individually enabled or disabled by using the menus on the actual Aladin Sport unit.



Read sections on warnings and alarms about the possible selections that you can modify on your Aladin Sport.

You may also change the shown units between metric/imperial. Select Extras > Options > Measurement Units:



## 7. TAKING CARE OF YOUR ALADIN SPORT

### 7.1 Technical information

Operating altitude:

With decompression – sea level to approximately 4000m/13300ft.

Without decompression (gauge mode) – at any altitude.

Max operating depth:

120m/394ft; resolution is 0.1m until 99.9m and 1m at depth deeper than 100m. Resolution in ft is always 1ft. Accuracy is within 2% ±0.3m/1ft.

Decompression calculation range:

0.8m to 120m/3ft to 394ft

Maximum environment pressure:

13bar/189psi

Clock:

Quartz; time, date, dive time display up to 199 minutes

Oxygen concentration:

Adjustable between 21% and 100%.

Operating temperature:

-10C to +50C/14F to 122F

Power supply:

CR2450 lithium battery

Life of the battery:

Estimated 2 years or 300 dives, whichever comes first. Actual battery life depends on the number of dives per year, the length of each dive, the water temperature and the usage of the backlight.

Bluetooth® transceiver:

Operating frequency 2402-2478 MHz, max power < 3 dBm, connection range approx. 2m.

### 7.2 Maintenance

The depth accuracy of your Aladin Sport should be verified every 2 years and can be done by an authorized SCUBAPRO dealer. Aside from that, the Aladin Sport is virtually maintenance-free. All you need to do is rinse it carefully with fresh water after each dive and change the battery when needed. To avoid possible problems with your Aladin

Sport, the following recommendations will help ensure years of trouble-free service:

- Avoid dropping or jarring your Aladin Sport.
- Do not expose your Aladin Sport to intense, direct sunlight.
- Do not store your Aladin Sport in a sealed container; always ensure that there is ample ventilation.
- If there are problems with the water contacts, use soapy water to clean your Aladin Sport and dry it thoroughly. Do not use silicone grease on the water contacts!
- Do not clean your Aladin Sport with liquids containing solvents.
- Check the battery capacity before each dive.
- If the battery warning appears, replace the battery.
- If any error message appears on the display, take your Aladin Sport to an authorized SCUBAPRO dealer.

### 7.2.1 Replacing the battery

(Use only the original SCUBAPRO battery kit with O-ring.)

The change must be made with particular care in order to prevent water from seeping inside. The warranty does not cover damage due to the improper replacement of the battery.

#### **⚠ WARNING**

Never touch the metal surface of the battery with bare fingers. The 2 battery poles must never be short-circuited.

#### **⚠ WARNING**

- A leaking battery cap may lead to the destruction of your Aladin Sport by water seeping in, causing your Aladin Sport to switch off without prior notice.
- Always open the battery compartment in a dry and clean environment.
- Only open the battery compartment to replace the battery.



Battery-changing procedure:

1. Dry your Aladin Sport with a soft towel.
2. Turn the battery cap with a coin or with a SCUBAPRO universal tool.
3. Remove the battery cap.
4. Remove the O-ring carefully. Do not damage the sealing surfaces.
5. Remove the battery. Do not touch the contacts.
6. Always insert a new O-ring when replacing the battery, and dispose of the old O-ring. Make sure that the new O-ring is in perfect condition, and that the O-ring, the O-ring groove and the sealing surfaces are free of dust and dirt. If necessary, clean the parts with a soft cloth. Fit the O-ring into the O-ring groove of the battery cap.

#### **⚠ WARNING**

If you notice traces of seeping water, damage, or other defects on the O-ring, do not use your Aladin Sport for further dives. Take it to an authorized SCUBAPRO dealer for inspection and repair.

#### **⚠ WARNING**

7. Use only an original SCUBAPRO O-ring. This O-ring is Teflon-coated and does not require additional lubrication.
8. Do not lubricate the O-ring as the lubricant will chemically attack the battery cap.

**⚠ WARNING**

9. Before installing, check the proper polarity of the battery. Your Aladin Sport can be damaged if you do not insert the battery correctly. Insert the new battery with the “+” facing outwards. Once the battery is replaced the Aladin Sport will perform an automatic test (8secs) and a short beep will sound when the test is done.

**⚠ WARNING**

10. The battery cap can be installed with a  $\pm 120^\circ$  offset. Push the battery cap firmly down and turn it clockwise until the 2 circles are aligned. The alignment circles are there to ensure proper positioning of the cap. If the rotation is stopped before alignment, water-tightness may not be ensured. If the rotation is forced beyond the alignment, the cap may break. Damage due to improper placement of the battery cap is not covered by the warranty.
11. Check your Aladin Sport by switching it on.
  - 12. Recalibrate the 3D compass. See chapter: Compass, section: Recalibrating the compass.

**⚠ WARNING**

- Do not ingest the battery, chemical burn hazard!
- This product contains a coin/button cell battery.
- If the coin/button cell battery is swallowed, it can cause severe internal burns in just 2 hours and can lead to death.
- Keep new and used batteries away from children. If the battery compartment does

not close securely, stop using the product and keep it away from children.

- If you think batteries might have been swallowed or placed inside any part of the body, seek immediate medical attention.
- Do not expose the product or battery to excessive heat, including direct sunlight or fire and store or use inside cars in hot weather, where it can be exposed to high temperatures.

 *NOTE: Protect the environment and dispose of the battery properly.*

**8. COMPLIANCE****8.1 EU Radio directive**

Hereby, Uwatec AG, declares that the radio equipment type PAN1740 is in compliance with Directive 2014/53/EU. The full text of the EU declaration of conformity is available at [www.scubapro.com/declarations-conformity](http://www.scubapro.com/declarations-conformity).

**8.2 Diving**

The Aladin Sport dive instrument is also compliant with the European standard EN 13319:2000 (EN 13319:2000 – Depth gauges and combined depth and time measuring devices – Functional and safety requirements, test methods).

**8.3 FCC & ISED regulatory notices****8.3.1 Modification Statement**

Uwatec has not approved any changes or modifications to this device by the user. Any changes or modifications could void the user's authority to operate the equipment.

**8.3.2 Interference Statement**

This device complies with Part 15 of the FCC Rules and Industry Canada license exempt RSS standard(s). Operation is subject to the following two conditions: (1) this device may not cause interference, and (2) this device must accept any interference, including interference that may cause undesired operation of the device.

### 8.3.3 Wireless Notice

This device complies with FCC/ISED radiation exposure limits set forth for an uncontrolled environment and meets the FCC radio frequency (RF) Exposure Guidelines and RSS-102 of the ISED radio frequency (RF) Exposure rules. This transmitter must not be co-located or operated in conjunction with any other antenna or transmitter.

### 8.3.4 FCC Class B Digital Device Notice

This equipment has been tested and found to comply with the limits for a Class B digital device, pursuant to part 15 of the FCC Rules. These limits are designed to provide reasonable protection against harmful interference in a residential installation.

This equipment generates, uses and can radiate radio frequency energy and, if not installed and used in accordance with the instructions, may cause harmful interference to radio communications. However, there is no guarantee that interference will not occur in a particular installation. If this equipment does cause harmful interference to radio or television reception, which can be determined by turning the equipment off and on, the user is encouraged to try to correct the interference by one or more of the following measures:

1. Reorient or relocate the receiving antenna.
2. Increase the separation between the equipment and receiver.
3. Connect the equipment into an outlet on a circuit different from that to which the receiver is connected.
4. Consult the dealer or an experienced radio/TV technician for help.

### 8.3.5 CAN ICES-3 (B) / NMB-3 (B)

This Class B digital apparatus complies with Canadian ICES-003.



Your dive instrument is manufactured with high-quality components that can be recycled and reused. Nevertheless, these components, if not properly managed in accordance with the regulations on electrical and electronic equipment waste, are likely to cause harm to the environment and/or to human health. Customers living in the European Union can contribute to protecting the environment and health by returning old products to an appropriate collection point in their neighborhood in accordance with EU Directive 2012/19/UE. Collection points are provided by some distributors of the products and local authorities. Products marked with the recycling symbol on the left must not be disposed of in normal household waste.

## 8.4 Manufacturer

UWATEC AG  
Bodenackerstrasse 3  
CH-8957 Spreitenbach  
SWITZERLAND

## 9. APPENDIX

### 9.1 Warranty

The Aladin Sport has a 2-year warranty covering defects in workmanship and function. The warranty only covers dive computers purchased from an authorized SCUBAPRO dealer. Repairs or replacements during the warranty period do not extend the warranty period itself. Excluded are faults or defects due to:

- Excessive wear and tear.
- External influences, e.g. transport damage, damage due to bumping and hitting, influences of weather or other
- natural phenomena.
- Servicing, repairs or the opening of the dive computer by anybody not authorized by the manufacturer.
- Pressure tests which do not take place in water.
- Diving accidents.
- Improper placement of the battery cap.

For European Union markets, the warranty of this product is governed by European legislation in force in each EU member state.

All warranty claims must be returned with dated proof-of-purchase to an authorized SCUBAPRO dealer.

Visit [www.scubapro.com](http://www.scubapro.com) to find your nearest dealer.

## 9.2 Glossary

AVG:	Average depth, calculated from the beginning of the dive or from the time of reset.
CNS O <sub>2</sub> :	Central Nervous System oxygen toxicity.
Desat:	Desaturation time. The time needed for the body to completely eliminate any nitrogen taken up during diving.
Dive time:	The time spent below a depth of 0.8m/3ft.
Gas:	Refers to the main gas that is set for the ZH-L16 ADT MB algorithm.
INT.:	Surface interval. Elapsed time since your last dive ended.
Local time:	The time in the local time zone.
Max depth:	Maximum depth reached during the dive.
MB:	Microbubble. Microbubbles are tiny bubbles that can build up in a diver's body during and after a dive.
MB level:	One of the six steps, or levels, in SCUBAPRO's customizable algorithm.
MOD:	Maximum Operating Depth. This is the depth at which the partial pressure of oxygen (ppO <sub>2</sub> ) reaches the maximum allowed level (ppO <sub>2</sub> max). Diving deeper than the MOD will expose the diver to unsafe ppO <sub>2</sub> levels.
Multi-gas:	Refers to a dive in which more than one breathing gas is used (air and/or nitrox).
Nitrox:	A breathing mix made of oxygen and nitrogen, with the oxygen concentration being 22% or higher. In this manual, air is considered as a particular type of nitrox.
No Fly:	Minimum amount of time a diver should wait before taking a plane.
No-stop time:	This is the time that a diver can stay at the current depth and still make a direct ascent to the surface without having to perform decompression stops.
O <sub>2</sub> :	Oxygen.
%O <sub>2</sub> :	Oxygen concentration used by the dive computer in all calculations.
PDIS:	Profile Dependent Intermediate Stop is an additional deep stop, which is suggested at the depth where the 5 <sup>th</sup> ..7 <sup>th</sup> compartment starts off-gassing.
ppO <sub>2</sub> :	Partial pressure of oxygen. This is the pressure of the oxygen in the breathing mix. It is a function of depth and oxygen concentration. A ppO <sub>2</sub> higher than 1.6bar is considered dangerous.
ppO <sub>2</sub> max:	The maximum allowed value for ppO <sub>2</sub> . Together with the oxygen concentration it defines the MOD.
Press:	The act of pressing and releasing one of the buttons.
Press-and-hold:	The act of pressing and holding one of the buttons for 1 second before releasing it.
SOS mode:	The result of having completed a dive without respecting all mandatory decompression obligations.
Stopwatch:	A stopwatch. To time certain steps of the dive.
UTC:	Universal Time Coordinated. Refers to time zone changes when traveling.