

A large, stylized logo consisting of a black circle with a white, curved shape inside that resembles a scuba diver's head and mask. The word "SCUBAPRO" is written in white, bold, sans-serif capital letters across the center of the circle.

SCUBAPRO[®]

**Aladin A2
User Manual**



deep down you want the best

scubapro.com

ALADIN A2 USER MANUAL

THE A2 DIVE COMPUTER – DESIGNED FOR EVERYDAY LIFE AND DIVING.

Welcome to SCUBAPRO dive computers and thank you for purchasing the A2. You are now the owner of an extraordinary partner for your dives and everyday life. This manual provides you with easy access to SCUBAPRO state-of-the-art technology and the A2's key features and functions. Should you wish to know more about SCUBAPRO diving equipment, please visit our website www.scubapro.com



⚠ IMPORTANT

Before using your SCUBAPRO A2, please carefully read and understand the Read First booklet that is included in the package.

⚠ WARNING

- The A2 has a depth rating of 120m/394ft.
- At depths between 115m/377ft and 120m/394ft in Dive mode the A2 provides alerts about the maximum depth, and at depths over 120m/394ft the A2 automatically switches to Gauge mode and cannot be used as a decompression computer for the remaining time of the dive.
- Diving at oxygen partial pressures higher than 1.6bar (corresponding to a depth of 67m/220ft when breathing compressed air) is extremely dangerous and could lead to serious injury or death.
- Never risk your life on only one source of information. Eventually, every computer has the potential to fail, so do not depend exclusively upon it and always have a plan for how to handle failures. Use a redundant dive computer, carry backup tables and depth/time instrumentation.

⚠ WARNING

The A2 is delivered in deep sleep mode where the display is off. You must activate the A2 with a press-and-hold of the SEL/ESC button before the first dive.

TABLE OF CONTENTS

1. INTRODUCTION TO THE A2	8
1.1 Switching on the A2	8
1.2 The watch screen	8
1.3 A2 buttons	9
1.4 Button lock	9
1.5 Bezel markings and symbols	10
1.6 Battery	11
1.7 Battery Safety Instructions	11
1.8 Operation modes	11
1.9 Basic settings	14
1.9.1 Time and date settings	14
1.9.2 User settings	14
1.10 SCUBAPRO Human Factor Diving™	15
2. A2 AS AN EVERYDAY WATCH	15
2.1 Clock setting functions	15
2.1.1 Setting the alarm clock	16
2.1.2 Setting UTC 1	16
2.1.3 Setting UTC 2	16
2.1.4 Setting the time	16
2.1.5 Setting the date	17
2.1.6 Display design	17
2.1.7 Time format	18
2.2 Sport mode	18
2.2.1 Stopwatch	19
2.2.2 Training mode	20
2.2.3 Swim mode	21
2.2.4 Apnea mode	21
2.2.5 Enabling the activity counter	22
2.3 Navigation	22
2.3.1 Using, calibrating and setting the compass	22
2.3.1.1 Bearing.....	23
2.3.1.2 Declination	23
2.3.1.3 Timeout.....	23
2.3.1.4 Recalibration	24
2.3.2 Reading the altitude, barometric and temperature values	25
3. A2 SETTINGS AND MENUS ON THE SURFACE	26
3.1 General settings	26
3.1.1 User settings	27
3.1.1.1 Workload.....	27
3.1.1.2 Backlight	28
3.1.1.3 Contrast	28
3.1.1.4 Units.....	28
3.1.1.5 Owner information	29
3.1.1.6 Desaturation reset	29
3.1.1.7 Service Information.....	29
3.1.2 Swim settings	30
3.1.2.1 Swim heart rate	30
3.1.2.2 Swim stroke depth and length	30
3.1.3 Sound settings	32
3.1.3.1 Buzzer.....	32

	3.1.3.2	Button beeps	32
	3.1.3.3	Dive warnings.....	32
	3.1.4	Checking the battery status	33
3.2		Dive settings on surface	33
	3.2.1	Dive mode selection	33
	3.2.2	Scuba mode settings	34
	3.2.2.1	Water type selection	34
	3.2.2.2	Microbubble level selection.....	34
	3.2.2.3	Dive display type	35
	3.2.2.4	Enabling CCR mode.....	35
	3.2.2.5	Enabling Sidemount mode	35
	3.2.2.6	Enabling PMG mode	36
	3.2.2.7	Enabling Trimix mode	36
	3.2.3	Apnea mode settings	36
	3.2.3.1	Total Apnea exercise depth.....	37
	3.2.3.2	Surface interval factor.....	37
	3.2.3.3	Dual depth alarm	38
	3.2.3.4	Dive depth incremental alarm.....	38
	3.2.3.5	Dive time interval alarm	39
	3.2.3.6	Surface interval alarm	39
	3.2.3.7	Low heart rate alarm.....	40
	3.2.3.8	Ascent speed alarm.....	40
	3.2.4	Warning settings	40
	3.2.4.1	Setting the dive time warning.....	41
	3.2.4.2	Setting the dive depth warning	41
	3.2.4.3	Setting the MOD alarm	41
	3.2.4.4	Setting the visual warning signal	41
3.3		Gas settings	42
	3.3.1	Setting gas oxygen content	42
	3.3.1.1	Predictive multi gas (PMG).....	43
	3.3.1.2	Trimix.....	43
	3.3.1.3	CCR.....	44
	3.3.2	Mounting and pairing the high pressure transmitter	45
	3.3.3	Nitrox reset time	47
	3.3.4	Full gas	47
	3.3.5	Setting the half tank warning	48
	3.3.6	Setting the tank reserve alarm	48
3.4		Planning a dive	48
	3.4.1	No-stop plan	48
	3.4.2	Decompression plan	49
3.5		Reading the logbook	49
	3.5.1	Dive statistics	50
	3.5.2	Step counter statistics	51
4.		DIVING WITH THE A2	51
	4.1	Display information	52
	4.1.1	Dive ready mode	52
	4.1.2	Display configuration during the dive	53
	4.1.2.1	SCUBA mode display selection	53
	4.1.2.1.1	Light version	53
	4.1.2.1.2	Classic version.....	54
	4.1.2.2	GAUGE mode display selection	54
	4.1.2.2.1	Light version	55

	4.1.2.2.2 Classic version.....	55
	4.1.2.3 APNEA mode	56
4.2	Safety stop timer	57
4.3	Activating the backlight	57
4.4	Alarms and warnings during diving	57
	4.4.1 Maximum depth warning	57
	4.4.2 MOD (ppO ₂ max) alarm	58
	4.4.3 AMD (ppO ₂ min) alarm	58
	4.4.4 Dive time warning	58
	4.4.5 Turning time	58
	4.4.6 No-stop time = 2 minute warning	58
	4.4.7 No-stop time warning	59
	4.4.8 CNS O ₂ warning (over 75%)	59
	4.4.9 CNS O ₂ alarm (100%)	59
	4.4.10 LO no-stop time = 2 minute warning	59
	4.4.11 Entering decompression warning	59
	4.4.12 Missed decompression stop alarm	60
	4.4.13 MB-level stop ignored	60
	4.4.14 MB-level reduction warning	60
	4.4.15 Ascent rate alarm	60
	4.4.16 SOS	61
	4.4.17 Low battery alarm	61
	4.4.18 Pressure signal	61
	4.4.19 RBT = 0 min	62
	4.4.20 Half tank warning	62
	4.4.21 Tank reserve alarm	62
4.5	No-Dive warning	62
4.6	No-Fly time	63
4.7	Diving with MB-levels	63
4.8	PDIS (Profile Dependent Intermediate Stop)	64
	4.8.1 Introduction to PDIS	64
	4.8.2 How does PDIS work?	65
	4.8.3 Diving with PDIS	66
4.9	Altitude diving	66
	4.9.1 Altitude warning after a dive	66
	4.9.2 Altitude and the Altitude and the decompression algorithm	67
	4.9.3 Prohibited altitude	68
	4.9.4 Decompression dives in mountain lakes	68
4.10	Diving with Nitrox	68
4.11	Diving in GAUGE mode	69
4.12	Diving in APNEA mode	70
4.13	Diving with CCR mode	71
4.14	Diving with Sidemount mode	72
4.15	Diving with multiple gas mixtures	73
	4.15.1 Switching gas mixture during the dive	74
	4.15.2 Switching back to a gas mixture with lower oxygen concentration	74
	4.15.3 Gas switch not carried out at the planned depth	74
	4.15.4 Delayed gas switch	75
	4.15.5 Submerging below the MOD after a gas switch	75
4.16	Diving with Trimix mode	75
	4.16.1 Absolute Minimum Depth and Maximum Operating Depth	76
	4.16.2 Gas selection	76
4.17	Setting bookmarks	76

5. INTERFACES FOR THE A2 AND AN INTRODUCTION TO LOGTRAK	77
5.1 Establishing Bluetooth communication	77
5.2 LogTRAK	77
5.2.1 Connecting the A2 with LogTRAK	77
5.2.2 Download dive profiles	78
5.2.3 Reading computer information	78
5.2.4 Writing owner information with LogTRAK	79
5.2.5 Setting units in LogTRAK	79
5.2.6 Updating your A2	79
6. A2 ACCESSORIES	81
6.1 Wireless high pressure transmitter	81
6.2 SCUBAPRO Heart Rate Belt	81
6.3 Digital Heart Rate Monitor	82
6.4 Watch straps	82
7. TAKING CARE OF YOUR A2	83
7.1 Changing the watch strap	83
7.2 Display protection foil	83
7.3 Technical information	84
7.4 Maintenance	84
7.5 Replacing the battery in the high pressure transmitter	85
7.6 Replacing the battery in the SCUBAPRO Heart Rate Belt	85
7.7 Replacing the battery in the Digital Heart Rate Monitor	86
7.8 Warranty	86
8. COMPLIANCE	87
8.1 CE regulatory notices	87
8.1.1 EU Radio Equipment Directive	87
8.1.2 EU Personal Protective Equipment Regulation	87
8.1.3 EU Depth Gauge Standard	87
8.1.4 EU Electromagnetic Compatibility Directive	87
8.1.5 EU declaration of conformity	87
8.2 FCC & ISED regulatory notices	87
8.2.1 Modification Statement	87
8.2.2 Interference Statement	87
8.2.3 Wireless Notice	87
8.2.4 FCC Class B Digital Device Notice	87
8.2.5 CAN ICES-3 (B) / NMB-3 (B)	88
8.3 Date of manufacture	88
8.4 Manufacturer	88
9. GLOSSARY	89

1. INTRODUCTION TO THE A2

Your A2 user manual is divided into the following main chapters:

Introduction to the A2. This chapter provides an overview of the A2 dive computer and describes its operating modes and main functions when on the surface.

A2 as an everyday watch. This chapter describes the A2's operation when it is used as a watch.

A2 settings and menus on the surface. This section goes through the settings of your A2.

Diving with the A2. This section takes you underwater with the A2 and describes all settings and functions of the A2 as a dive computer. It outlines everything the A2 can—and will—do to enhance your safety and fun underwater.

Interfaces for the A2 and an introduction to LogTRAK. This section describes how to download data, change settings, and manage your logbook.

A2 accessories. This chapter briefly describes the extras that can be purchased as additional options to get the most of your dive computer in all diving conditions.

Taking care of your A2. This chapter describes how you should take care of your A2 after underwater adventures, and also summarizes the main technical information of this instrument.

The A2 is a technologically-advanced instrument that can accompany you during your underwater adventures while providing you with accurate depth, time and decompression information. On the surface its size makes it your ideal everyday companion. With features such as wake-up alarm, dual time, stopwatch, barometer, altimeter and swim mode, the A2 can tackle almost every possible task. The buttons allow you to initiate operating functions, make setting changes and access menus while on the surface. During the dive they show additional information on the computer screen and activate the backlight.

Now it is time to dive into the details. We hope you will enjoy getting to know your new computer and we wish you many happy dives with the A2.

1.1 Switching on the A2

The A2 is delivered to you in a deep sleep mode. This is done to preserve battery life and to ensure your A2 arrives with a fresh battery.

In order to switch on the A2 for the first time you need to press-and-hold the SEL/ESC button (lower left). After this initial activation, the A2 will never again return to deep sleep mode.

1.2 The watch screen

When the A2 is switched on the first time the display screen shows the time and date as follows:



The time and date values, along with the format, can be changed to your liking. This is described in chapters **2.1.6 Display design** and **2.1.7 Time format**.

1.3 A2 buttons



The functions of the buttons **on the surface** are summarized in the table below and explained in detail in the following sections.

“LIGHT” button, Top Left:	Press = backlight Press-and-hold = launch compass
“SEL/ESC” button, Bottom Left:	Press = select (access main menu and submenus or confirm selection / setting) Press-and-hold = escape (return to previous menu or cancel the setting); from the main time and date display shows the current gas settings
“+/UP” button, Top Right:	Press = adds numerical values, toggles up to the previous menu Press-and-hold = from the main time and date display shows the selected dive mode; from the selected dive mode display activates the swim mode
“-/DOWN” button, Bottom Right:	Press = subtracts numerical values, toggles down to the next menu Press-and-hold = from the main time and date display: shortcut to dive ready mode which shows the main dive settings

1.4 Button lock

A simultaneous press-and-hold of the SEL/ESC and -/DOWN buttons will lock the main time and date display. Once locked, by pressing just the SEL/ESC button the following screen will be displayed:

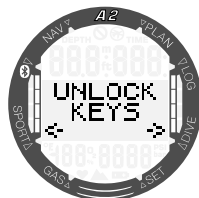

Unlock the display by simultaneously pressing-and-holding the SEL/ESC and -/DOWN buttons again.

1.5 Bezel markings and symbols

In this section the markings and symbols on the A2's outer and inner bezel as well as on its display are explained in detail.

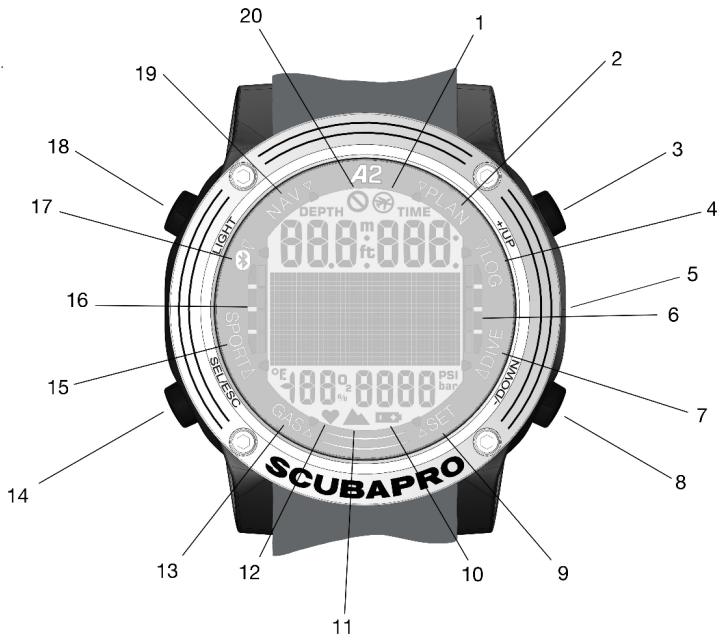

1	No-fly symbol
2	Planner menu indicator
3	+ / UP button
4	Logbook menu indicator
5	Water contact
6	Active tank pressure indicator bar
7	Dive menu indicator
8	- / DOWN button
9	Settings menu indicator
10	Low battery symbol

11	Altitude symbol
12	Heart rate detection symbol
13	Gas menu indicator
14	SEL / ESC button
15	Sport menu indicator
16	Ascent speed / N2 bar
17	Bluetooth menu indicator
18	Light button
19	Navigation menu indicator
20	No-dive symbol

1.6 Battery

The A2 uses a CR2450 battery type. The A2 will alert you when the battery is approaching a critical discharge level by displaying the battery symbol.

A steady symbol means that the battery is low, with some reserve left. At this point the backlight cannot be activated. If the symbol blinks, the battery level is dangerously low and the backlight and alarm tones cannot be activated; diving is not recommended before replacing the battery.



⚠ WARNING

Starting a dive when the battery symbol is blinking can cause the computer to fail during the dive! Replace the battery before any diving activity if the blinking battery symbol appears. When the “no-dive” symbol appears with the battery symbol, the A2 cannot be used for diving until a fresh battery is installed.



Please refer to chapter **3.1.4 Checking the battery status** for details on how to manually trigger the battery level check.

⚠ WARNING

The A2 will not start a dive if the battery has reached the critical level indicated by the battery symbol. In this state the A2 cannot be used for diving.

⚠ WARNING

When your A2's battery reaches the end of its lifetime, it is recommended that it be replaced by an authorized SCUBAPRO service center.

1.7 Battery Safety Instructions

- Do not ingest the battery, chemical burn hazard!
- This product contains a coin/button cell battery.
- If the coin/button cell battery is swallowed, it can cause severe internal burns in just 2 hours and can lead to death.
- Keep new and used batteries away from children. If the battery compartment does not close securely, stop using the product and keep it away from children.
- If you think batteries might have been swallowed or placed inside any part of the body, seek immediate medical attention.
- Do not expose the product or battery to excessive heat, including direct sunlight or fire and store or use inside cars in hot weather, where it can be exposed to high temperatures.

1.8 Operation modes

The A2's different modes are shown on the dial ring of the computer and the current function mode is indicated with an arrow. Each mode may have sub functions and menus. By pressing the SEL/ESC button you activate the mode and as an indication the arrow starts blinking.

The modes are grouped and described in this manual in four chapters:

1. A2 as an everyday watch.
2. A2 settings and menus.
3. A2 as a dive computer.
4. Bluetooth interface of the A2 and an introduction to LogTRAK.

The A2 has two main operation modes:

1. **Watch mode.** The display is on and shows the time and date (in various formats). From this mode other surface operation modes can be selected:
 - a. Sport mode
 - b. Bluetooth communication mode
 - c. Compass
 - d. Altimeter
 - e. Dive planner
 - f. Logbook

As well as settings can be changed:

- a. Dive settings
 - b. User settings
 - c. Gas settings
2. **Dive mode.** This mode is activated when the computer reaches a depth of 0.8m/3ft or more. In this mode the A2 monitors depth, time, temperature and decompression.

The following chart describes the main menu structure:

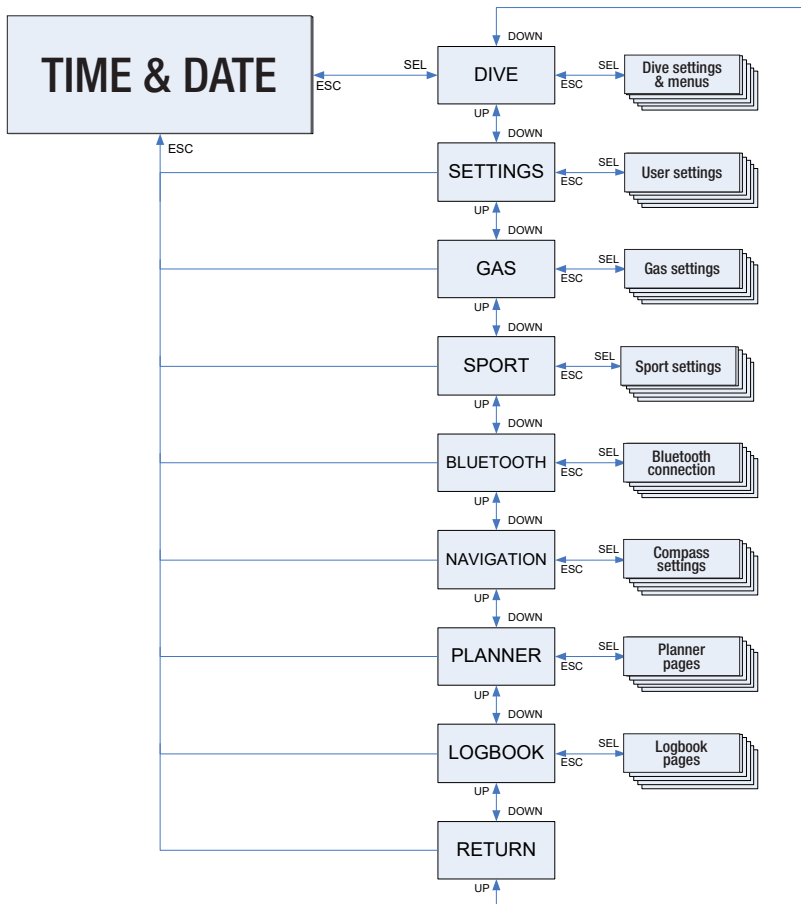

1.9 Basic settings

The initial activation of your A2 requires some basic set-up (setting time and date, units, etc.).

1.9.1 Time and date settings

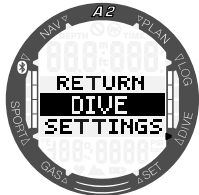

Starting from the main time and date display, pressing the SEL/ESC button takes you to the main menu.

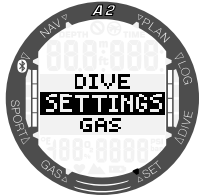

From the main menu toggle down to **Settings** with the -/DOWN button then press SEL/ESC.

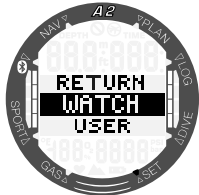

From the **Settings** menu toggle down to **Watch** then press SEL/ESC.

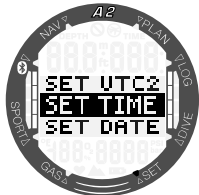

From the **Watch** menu toggle down to **Set Time** then press SEL/ESC.

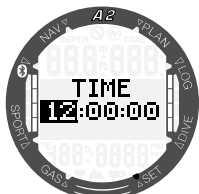

By pressing +/UP or -/DOWN you can select the hours and confirm them by pressing SEL/ESC. The minutes can be set the same way.

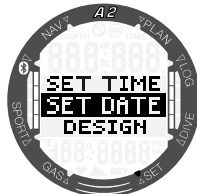

After the minutes are confirmed the date can be adjusted the same way.

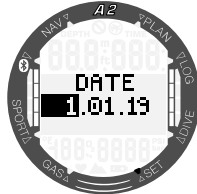

There are additional watch settings that you can adjust to your liking. These are described in chapter **2.1 Clock setting functions**.

1.9.2 User settings

The user-related settings (backlight duration, display contrast, units, etc.) can be selected with a press-and-hold of the SEL/ESC button which returns you to the previous submenu.

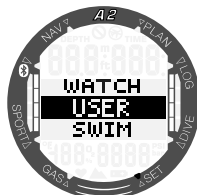

For example, from the **Settings** menu toggle down to **User** then press SEL/ESC.



From the **User** menu toggle down to **Units** then press SEL/ESC.

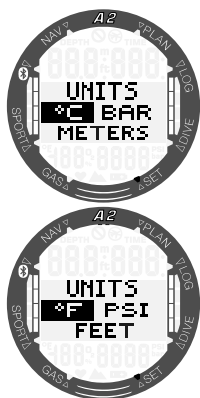

Now the various units can be selected. These selections are effective in all operating modes; for example, during diving your depth can be shown in meters or in feet.

1.10 SCUBAPRO Human Factor Diving™

The A2 has patented underwater Heart Rate, Skin Temperature and Breathing monitors. These features will customize every dive based on your body reactions and provide you more data that enhances your diving experience and helps you to become a more advanced diver.

To learn more about the physiology of the SCUBAPRO Human Factor Diving™, see the booklet: "HEARTRATE MEASUREMENT FOR BETTER WORKLOAD ASSESSMENT," Dr. T. Dräger, Dr. U. Hoffmann, 2012 www.scubapro.com.

 **NOTE:** Refer to chapter **3.1.1.1 Workload** to learn how to enable the A2's heart rate monitor function

2. A2 AS AN EVERYDAY WATCH

The A2 is more than just a watch. It features:

- Stopwatch with lap time and 72 hours of run time.
- Swim stroke and distance counter.
- Navigation compass.
- Altimeter for tracking your excursions to the mountains.
- Thermometer and barometer for current weather conditions.
- Heart rate monitor function.
- Wireless air integration.
- Step counter / activity tracker.
- Wake-up alarm function.
- Dual time.

2.1 Clock setting functions

Starting from the main time and date display, press the SEL/ESC button to enter the main menu.

From the main menu, toggle down to **Settings** with the -/DOWN button, then press SEL/ESC. From the **Settings** menu, select **Watch** to enter the clock settings.

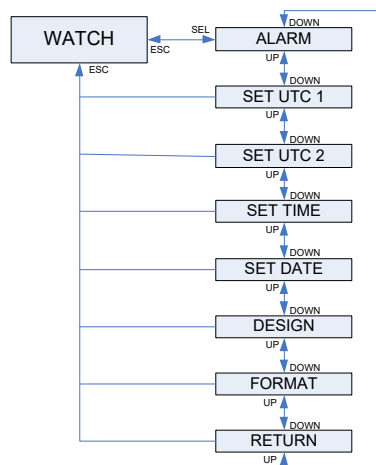

2.1.1 Setting the alarm clock

From the **Watch** menu press the SEL/ESC button to enter the **Alarm** submenu. Here you can activate or deactivate the alarm clock by pressing the +/UP or -/DOWN buttons. Selecting **ALARM ON** will allow you to set the time of the alarm. You can scroll the hours by pressing +/UP or -/DOWN buttons. Pressing SEL/ESC will confirm the hour setting and switch to minutes. You can scroll the minutes by pressing +/UP or -/DOWN buttons. Pressing the SEL/ESC button will confirm the minutes setting and activate the alarm.

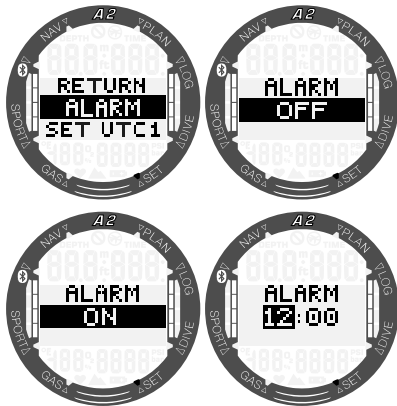

2.1.2 Setting UTC 1

The UTC setting will change the displayed time compared to Greenwich 0-Meridian. This feature is practical when traveling through different time zones. By pressing SEL/ESC you may edit the hours with +/UP or -/DOWN buttons in a range of +14h to -13h. By pressing SEL/ESC the minutes will be highlighted and you may edit them with +/UP or -/DOWN buttons in 15-minute increments. The UTC 1 setting will be confirmed by pressing the SEL/ESC button.

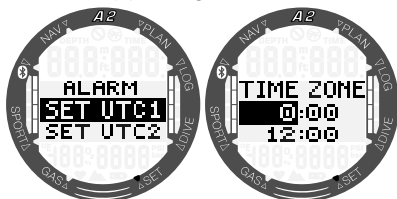

2.1.3 Setting UTC 2

Dual time uses the same “base time” as the main clock. Therefore, adjusting the time as described in section ‘Setting the time’ will also influence the dual time. The dual time zone selection will define the difference to the main clock time. When the time zone selection is OFF, then the dual time is disabled. When pressing the SEL/ESC button the UTC 2 time hours will be highlighted. You may change the setting by pressing the +/UP or -/DOWN buttons in a range of +14h to -13h or by selecting OFF. By pressing the SEL/ESC button, the minutes will be highlighted and you may edit them using the +/UP or -/DOWN buttons in 15-minute increments. The UTC 2 setting will be confirmed by pressing the SEL/ESC button.

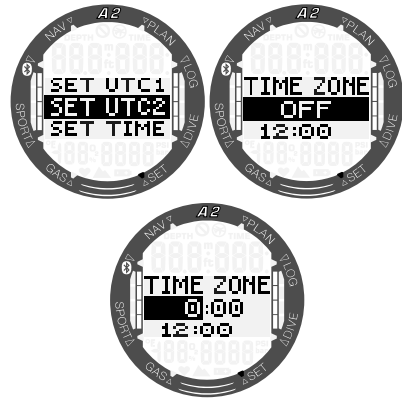

2.1.4 Setting the time

By pressing the SEL/ESC button in the **Set Time** submenu the time setting will be activated. You may change the hours with +/UP or -/DOWN buttons. By pressing the SEL/ESC button the selection will change to minutes and can be edited. The new time setting will be confirmed by pressing the SEL/ESC button.

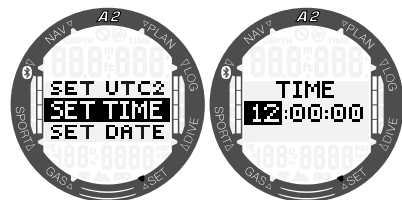

 **NOTE:** seconds cannot be edited; they always start counting from 0.

2.1.5 Setting the date

By pressing the SEL/ESC button in the **Set Date** submenu the first two digits will be highlighted. You may change them by pressing the +/- UP or -/DOWN buttons. Change the selection to the next two digits by pressing the SEL/ESC button. Finally, set the year by pressing +/- UP or -/DOWN and confirm the date with the SEL/ESC button. In 24h time format the first digits in the date are days, in AM/PM time format the month is first. You can toggle between 24h and AM/PM in the Format submenu.

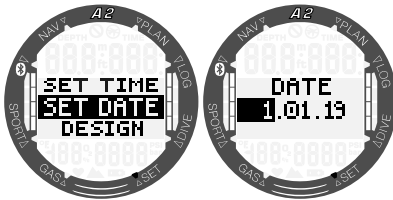

2.1.6 Display design

In this menu you may select the design of the main time and date display to suit your personal preferences by scrolling through the options with the +/- UP or -/DOWN buttons. Confirm your selection by pressing the SEL/ESC button. In the following screens the display design selection is shown next to how the layout is presented on the main watch display screen.

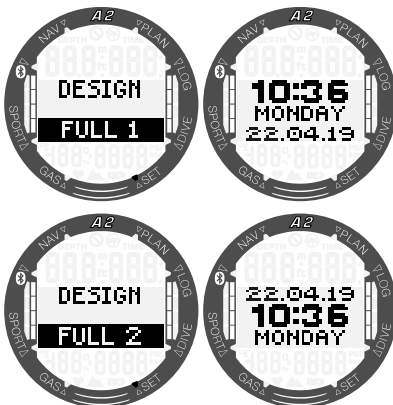

2.1.7 Time format

Choose your preferred time format by scrolling with the +/- UP or -/DOWN buttons, press the SEL/ESC button to save your settings. You can choose between AM/PM or 24-hour format.

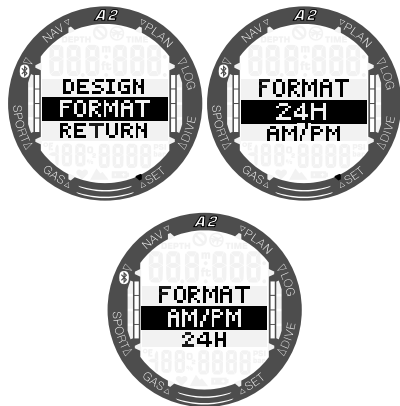

NOTE: Time format will also change the date format: MM/DD/YY in AM/PM mode and DD/MM/YY in 24h mode. This change will take place, for example, in watch mode, logbook, etc.

2.2 Sport mode

Starting from the main time and date display, press the SEL/ESC button to enter the main menu, then toggle down to **Sport** and press the SEL/ESC button again to enter the **Sport** menu. In this menu sport-related functions like swim stroke counter, stopwatch or activity counter (training) can be activated.

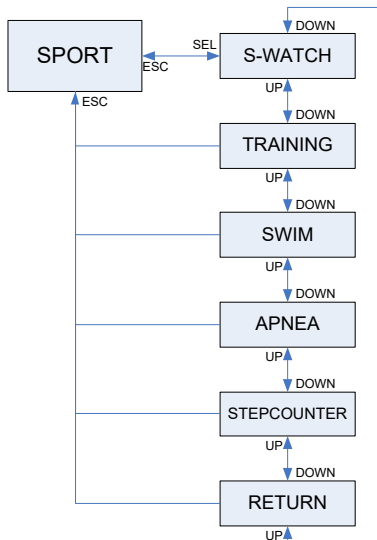

The functions of the buttons in **Sport mode** are summarized in the table below and explained in detail in the following sections.

“LIGHT”	<p>Press = backlight</p> <p>Press-and-hold in Swim mode = launch the compass</p> <p>Press-and-hold in Stopwatch mode = returns to the main time and date display (stopwatch will still be running in the background)</p>
“SEL/ESC”	<p>Press in Swim mode = stops/restarts timer</p> <p>Press-and-hold in Swim mode = ends swim exercise</p> <p>Press in Stopwatch mode = returns to Sport menu</p> <p>Press-and-hold in Stopwatch mode = returns to Sport menu</p> <p>Press in Training mode = set bookmark</p>
“+/UP”	<p>Press = scrolls through the alternative displays</p> <p>Press-and-hold in Swim mode = ends swim exercise</p> <p>Press in Stopwatch mode = manually start/stop timer</p> <p>Press-and-hold in Stopwatch mode when timer stopped = reset timer to zero</p> <p>Press-and-hold in Training mode = stops/restarts timer</p>
“-/DOWN”	<p>Press = scrolls through the alternative displays</p> <p>Press in Stopwatch mode when timer stopped = scrolls through laps</p>

2.2.1 Stopwatch

From the **Sport** menu press SEL/ESC to enter the **Stopwatch** submenu.

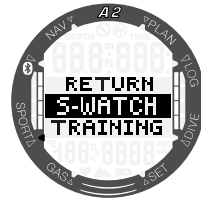

The stopwatch will start measuring the time by pressing the +/UP button.

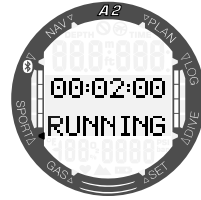

To pause the time on the stopwatch press the +/UP button once again. To reset the time to 0 press-and-hold the +/UP button while the stopwatch display shows the status STOPPED.

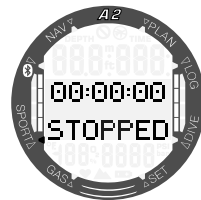

In addition to time, laps can be marked by pressing the -/DOWN button while the stopwatch is running. By doing so the lower part of the screen will show the number of the lap while the lap time will be displayed in the upper part of the screen. While the stopwatch is stopped you can review your lap times from the memory by repeatedly pressing the -/DOWN button.

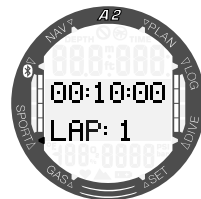

By pressing-and-holding the SEL/ESC button you can exit the stopwatch and return to the **Sport** menu.

☞ *NOTE: You can leave the stopwatch actively counting or you can leave the stopped time on the display. The status will be stored in memory, allowing you to continue from the same display at a future time.*

2.2.2 Training mode

From the main menu toggle down to **Sport** and press SEL/ESC to enter.

Pressing the SEL/ESC button in the **Training** submenu will start the exercise. A press-and-hold of the same button will end the exercise.



In the middle row the time is counting. The counter can be stopped and restarted by a press-and-hold of the +/UP button. The current time is displayed on top, stop timer in the middle, temperature in the bottom left and the heart rate in the bottom right of the screen.



The information in the middle row can be scrolled through by pressing the +/UP or -/DOWN buttons. A press of the +/UP button will change the top row information in the following order:



Air pressure in millibars.



Total ascent during the exercise



Altitude difference during the exercise



Current altitude.



Minutes per 1000 repetitions.



Repetitions per minute.



Step (repetition) count during current exercise.

NOTE: Since the A2 is worn on the wrist, it is counting repetitive movements from its internal sensors in Sport mode. The A2 is not a pure step counter since arm movements may count as repetitions as well. The A2 is also not an activity band since only same-direction movements are counted.

NOTE: Refer to chapter 3.5.2 Step counter statistics to learn how to review your weekly or monthly statistics from the logbook.

2.2.3 Swim mode

Swim mode combines a stopwatch with a stroke and distance counter. For proper counter operation the user's pending values can be adjusted. These are described in chapter 3.1.2 Swim settings.

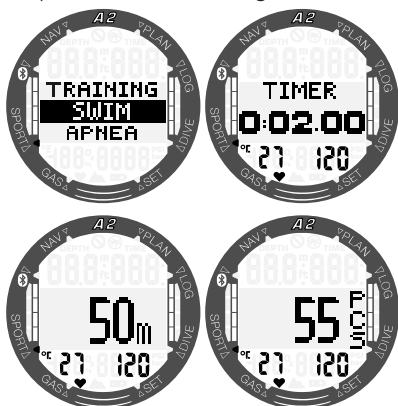

When the swim mode is activated, the duration of your swim will be shown on the second screen. The distance will be displayed on the third screen and the last screen will show the number of swim strokes. The water temperature is shown

in the bottom left of the display. When the heart rate function is activated, the values will be displayed in the bottom right corner of the screen. Switch between displays by pressing the +/UP or -/DOWN buttons. A press of the SEL/ESC returns you to the **Sport** menu.

NOTE: Swim mode stays active in shallow water down to 3 meters. This allows flip turns in pool and horizontal dives. An immersion deeper than 3 meters will start a dive in the mode which is selected in the A2 (SCUBA, APNEA or GAUGE).

2.2.4 Apnea mode

Apnea exercise mode can be activated from the **Apnea** menu. The session starts with a surface interval.

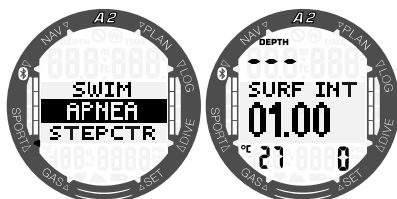

Apnea mode settings are described in chapter 3.2.3 Apnea mode settings. Display information and diving with this mode is described in chapter 4.1.2.3 APNEA mode.

2.2.5 Enabling the activity counter

The A2 has a step counter that can be switched on in order to count your daily activity. This functionality is running in the background of the A2's normal watch operation. During diving the activity counter is deactivated.

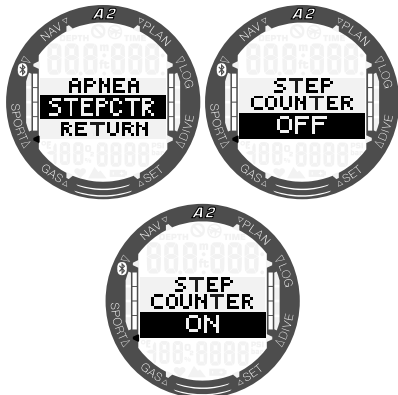

If the A2's step counter is enabled in the background (ON), you can set the LCD display to switch off when there is no motion detected. The time after the display would switch off can be set from 1 to 240 minutes or you can set the display to stay active even when there is no motion detected by selecting "never" in this menu.

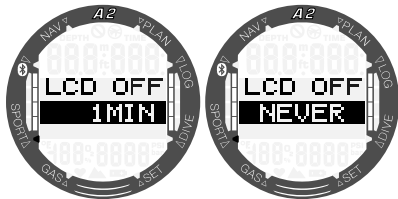

NOTE: If you do not wish to track your daily activity with the A2, you can disable the activity counter by selecting OFF in this menu. This will also help preserve the battery's lifetime.

NOTE: Refer to chapter **3.5.2 Step counter statistics** to learn how to review your daily, weekly or monthly statistics from the logbook.

2.3 Navigation

From the main menu toggle down to the **Navi** submenu and enter by pressing the SEL/ESC button. In this section compass related settings as well as information about the altitude, barometric and temperature values can be selected.

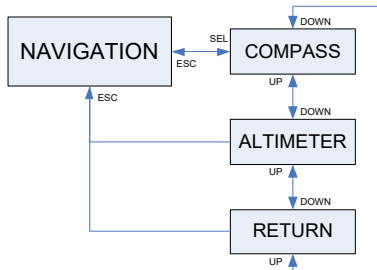

2.3.1 Using, calibrating and setting the compass

In this section compass related settings are described in detail. The different settings can be selected in the following submenus:

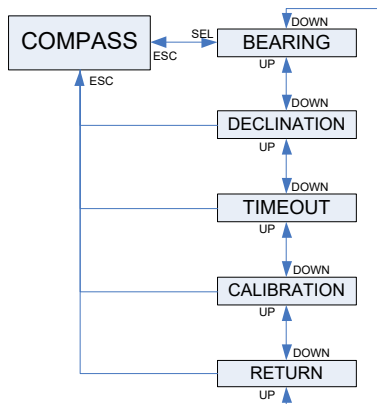

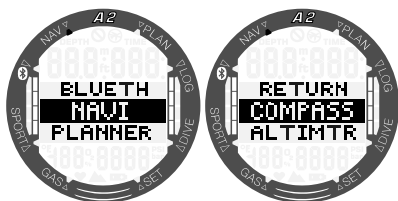

2.3.1.1 Bearing

By pressing the SEL/ESC button the compass will be launched and show the bearing direction (12 o'clock on the watch) in the middle row in degrees.

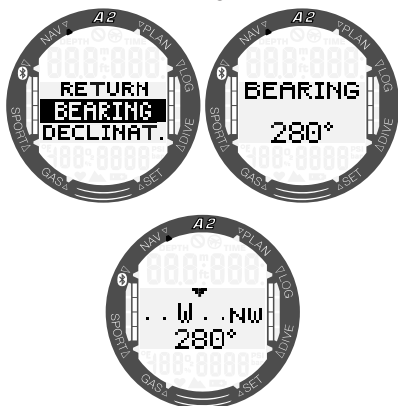

2.3.1.2 Declination

A compass points to the magnetic north pole of the earth. Geographic and magnetic north poles are corrected with a declination setting. Declination depends on your current location on the earth.

By pressing the SEL/ESC button the declination value will be highlighted. By pressing the +/UP or -/DOWN buttons you can select the value from -90 to 90° in 1° increments. By pressing SEL/ESC the value will be confirmed.

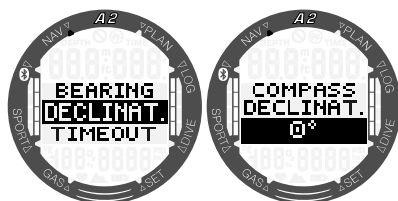

2.3.1.3 Timeout

Compass timeout is the amount of time the compass is displayed when activated. Compass timeout is valid for the display of the compass in all modes: Dive, Sport, etc. You can adjust the timeout setting by pressing SEL/ESC and scrolling the values by pressing the +/UP or -/DOWN buttons between 5, 10, 15, 30 and 60 seconds or PUSH (on/off). By pressing the SEL/ESC button the value will be confirmed.

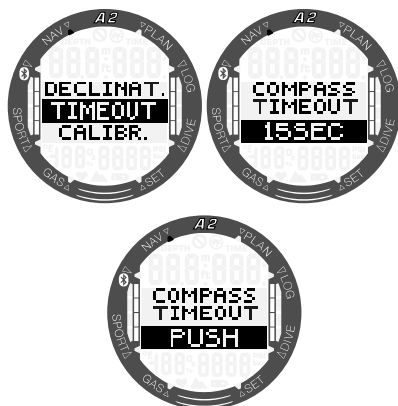

2.3.1.4 Recalibration

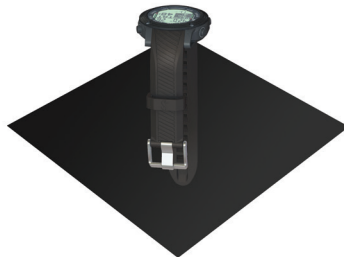
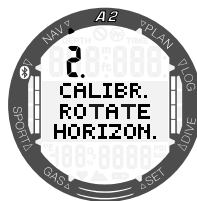
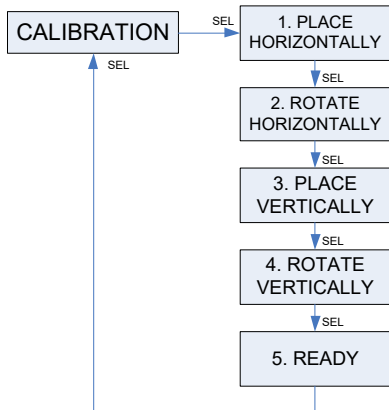

NOTE: The compass must be recalibrated after each battery change or when traveling to a location where the earth's magnetic field strength is different.

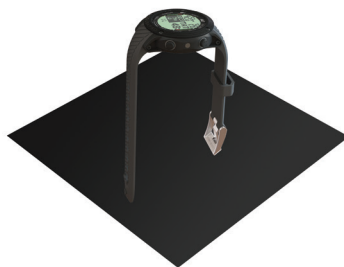

By pressing the SEL/ESC button the recalibration process will start.

- 1. Place horizontally.** Hold the A2 so that its display points upwards. Press the SEL/ESC button.

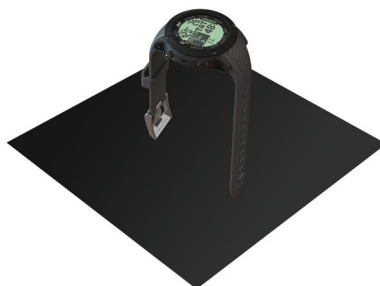

- 2. Rotate horizontally.** Rotate the A2 at least 180° horizontally. Press the SEL/ESC button.

3. **Place vertically.** Hold the A2 so that its display points sideways. Press the SEL/ESC button.



4. **Rotate vertically.** Rotate the A2 at least 180° vertically. Press the SEL/ESC button.

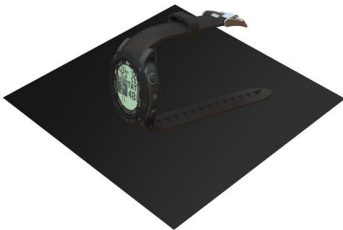
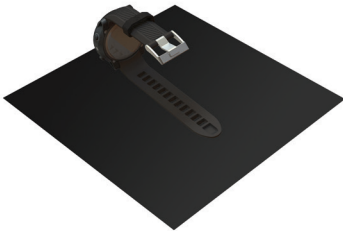
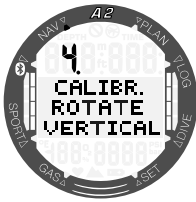

5. **Calibration ready.** The A2's 3D compass recalibration is now complete.



2.3.2 Reading the altitude, barometric and temperature values

In the **Navigation (Navi)** menu toggle down to **Altimeter (Altimtr)** and press the SEL/ESC button to enter. In this submenu on the first display the current altitude (in meter or feet) is calculated from the barometric pressure and shown in the middle of the screen. The temperature (in Celcius or Fahrenheit) and air pressure (in mbar) at your current altitude are displayed in the bottom left and bottom right of the screen, respectively.

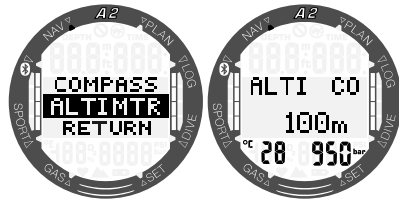

NOTE: Barometric pressure is a variable, changing with weather and atmospheric pressure at a particular elevation. The Dive algorithm uses Altitude Classes which are directly derived from the barometric pressure. Altitude is counted from the current barometric pressure and is therefore a relative value.



By pressing the +/UP or -/DOWN buttons you can switch to an additional display where the atmospheric pressure at sea level is shown.

The altitude can be adjusted when current elevation is known by pressing the SEL/ESC button. The new altitude value will be highlighted in the center of the screen. By pressing +/UP or -/DOWN buttons the value can be adjusted in 10m/50ft increments.

This Barometer feature allows you to foresee approaching weather in the upcoming hours if your altitude remains the same.

3. A2 SETTINGS AND MENUS ON THE SURFACE

In this chapter the settings that can be completed on the surface are described. These settings will allow you to personalize your A2 as desired.

3.1 General settings

In the **Settings** menu the following functions can be set:

- Watch settings – please refer to chapter **2.1 Clock setting functions.**
- User settings – workload, backlight, display contrast, units, owner info, desaturation reset, service check, current software version.
- Swim settings – swim heart rate, swim stroke depth and length.
- Sound settings – enable or disable button beeps, dive warnings.
- Battery – check battery status.

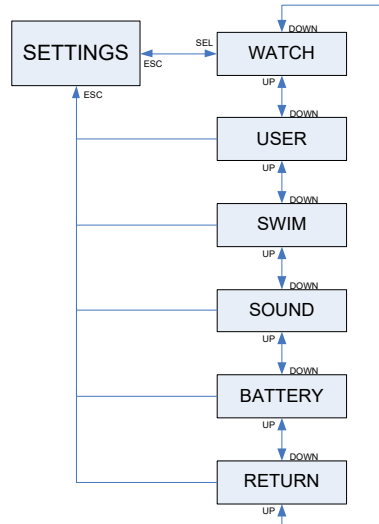

3.1.1 User settings

This section allows you to customize your A2 to your liking. Settings like backlight duration, display contrast and units can be changed here.

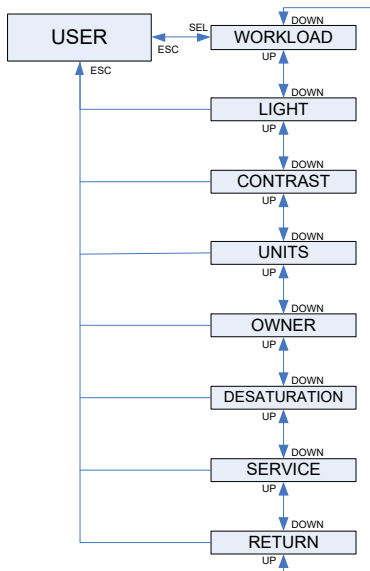

3.1.1.1 Workload

At the base of any decompression calculation there is the transport of nitrogen from the lungs to the blood and from there to the tissues during on-gassing, and the same but in reverse during off-gassing. As such, it is obvious that the single most important parameter in a decompression calculation is the rate at which blood travels through the body. During heavy exercise, the total blood flow from the heart can be up to 4 times higher than while at rest. This increase in blood flow is rather unevenly distributed, with some tissues such as the Central Nervous System and the brain being unaffected, while others like the muscles receiving up to 10 times more blood than when at rest.

The A2 estimates workload based on heart rate or changes in breathing pattern from the high-pressure transmitter, and the decompression calculation in the ZH-L16

ADT model is changed accordingly. This menu allows you to select the workload base or switch off the workload estimation, in which case your A2 will behave like the SCUBAPRO dive computer models without heart rate or air integration.

In the workload menu you can scroll the parameters which are used to measure your workload during the dive by pressing the +/UP or -/DOWN buttons. If you select the heart rate by pressing the SEL/ESC button, the heart rate limits can be edited. The base level indicates your average light moving heart rate limit and the maximum heart rate is what you can reach under extreme exercise. Select the values with +/UP or -/DOWN and confirm with the SEL/ESC button.

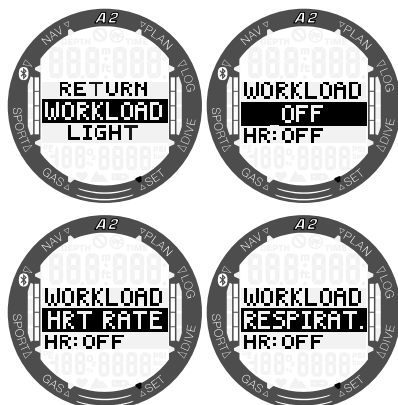

SCUBAPRO recommends using the workload and Heart Rate features on all dives, but especially when making technical dives. When the dive goes as planned there is no effect to the decompression schedule. However, when workload is high more decompression time will be required. Adaptive algorithm additionally incorporates into the calculation the water or skin temperature (only with the patented SCUBAPRO Heart Rate belt) and micro bubble formation.



You can also select the workload to be measured from breathing by selecting the “respiratory” or a combination of heartrate and breathing where both parameters are measured and the higher or lower parameter is used by the algorithm.

When heartrate is not selected as a workload parameter, the heart rate monitor can be still shown in the screen during diving. This can be selected at the lower field where HR can be selected to be ON or OFF. Confirm the selection by pressing the SEL/ESC button.

3.1.1.2 Backlight

In the **User** submenu press SEL/ESC to access the backlight settings. The duration of the backlight can be set from 5 up to 30 seconds using +/UP or -/DOWN buttons and saved with another press of the SEL/ESC button.

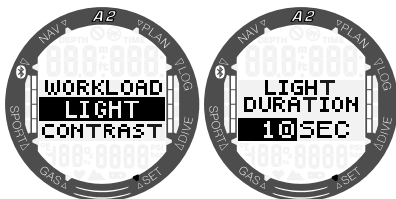

3.1.1.3 Contrast

In the **User** submenu toggle down to **Contrast** and press SEL/ESC to access the display contrast settings. Contrast can be set from 0 up to 15 using +/UP or -/DOWN and saved with another press of the SEL/ESC button.

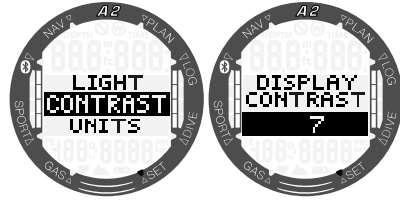

3.1.1.4 Units

Different combinations of temperature, air pressure and height or depth measurement units can be selected in the **Units** submenu.

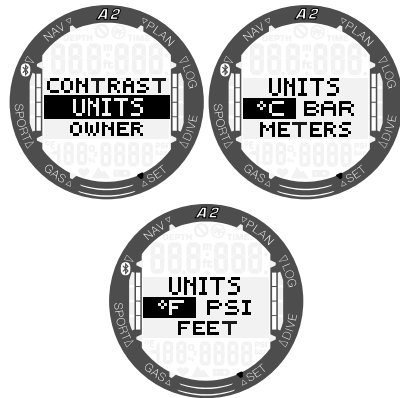

NOTE: Setting units can be completed directly in your A2’s **Units** submenu or on your PC/MAC and personal hand held device using the program LogTRAK. For further guidance on how to set units with LogTRAK, please refer to chapter 5.2.5 Setting units in LogTRAK.

3.1.1.5 Owner information

You can input owner's information using the LogTRAK program. This function is described in detail in chapter 5.2.4 Writing owner information with LogTRAK.

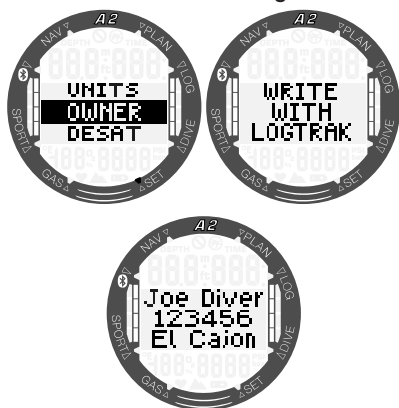

3.1.1.6 Desaturation reset

When the A2 is still counting down the desaturation, some menu changes are not possible. In the event you decide to reset the desaturation, the safety code 313 must be entered. This procedure prevents unwanted resetting and stores the desaturation reset in memory (in the next dive log the desaturation symbol will be shown).

By pressing the SEL/ESC button in the **Desat** submenu, the code page appears. The first digit will be highlighted, and can be edited by pressing the +/UP or -/DOWN buttons. By pressing the SEL/ESC button the number is confirmed and the next number will be highlighted. When the code is entered correctly and then confirmed by pressing the SEL/ESC button, the desaturation reset is complete.

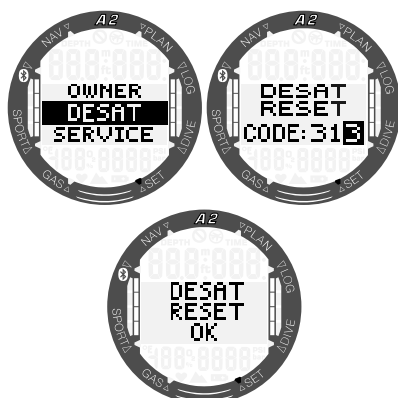

⚠ WARNING

Resetting desaturation will affect calculations of the algorithm which may lead to serious injury or fatal issue. Do not reset desaturation without having a very good reason.

3.1.1.7 Service Information

The date of the last service by an authorized SCUBAPRO dealer is shown in this submenu.

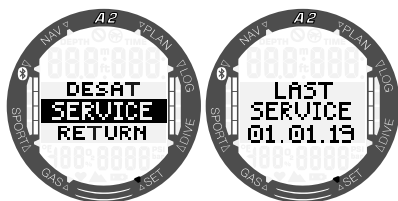

NOTE: Only an authorized SCUBAPRO service center, which has the proper tools and instruments, can reset the service date. The service date is only set after the A2's seals are checked and verified.

Pressing the +/UP button from the "last service" screen shows the current software version of the A2. You can download the latest version from the SCUBAPRO website, see chapter 5.2.6 Updating your A2.

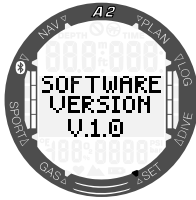

By pressing +/UP from the “software version” screen the Bluetooth version information will be displayed.

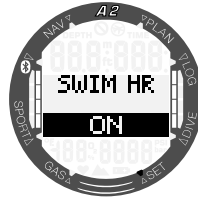
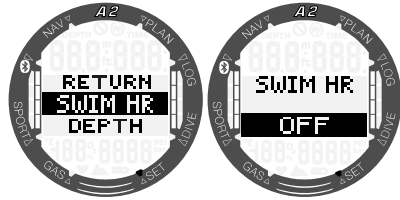
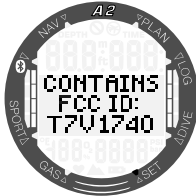

NOTE: The A2's heart rate monitor function is only compatible with the patented SCUBAPRO heart rate belt.

3.1.2 Swim settings

Next on the **Settings** menu listing is **Swim**. Press the SEL/ESC button to enter.

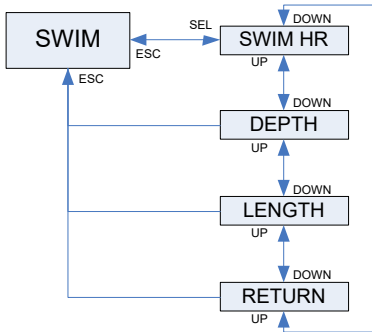

3.1.2.2 Swim stroke depth and length

For the swim stroke counter you must set the cycle threshold — how much depth difference is counted as a stroke cycle, as well as the distance per cycle (stroke length) — in order to achieve proper results.

The following illustration shows the parameters:

3.1.2.1 Swim heart rate

By pressing the SEL/ESC button in the swim heart rate menu you can choose if you want your heart rate monitored during the swim exercise. Select ON or OFF by pressing +/UP and confirm your selection by pressing the SEL/ESC button.

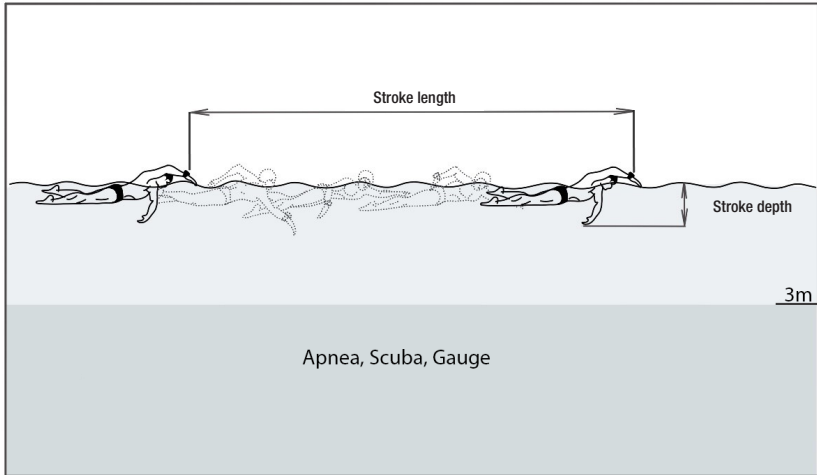

By pressing the SEL/ESC button in the **Swim** menu, you reach the swim mode settings. By pressing the SEL/ESC button the counter stroke threshold (first depth, then length) will be highlighted. A too large threshold setting will detect only a large movement as a stroke, a too small setting may detect too many strokes. You must test and adjust this according to your swimming style. By pressing the +/UP or -/DOWN buttons the value can be selected from 2cm/1in to 40cm/16in. A short press of the SEL/ESC button saves the setting.

a step length to convert the distance. You can calibrate this in a swimming pool where you know the length and can use the A2 stroke count to calculate the correct length.

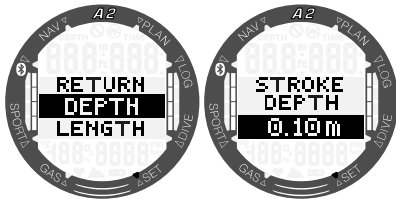
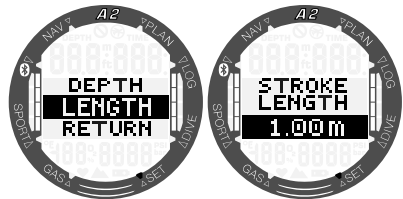

Pressing the SEL/ESC button will take you back to the previous submenu where you can toggle down to the stroke length settings. These values can be set from 0.5m/2ft to 5.0m/16ft by pressing the +/UP or -/DOWN buttons. Confirm your settings by pressing the SEL/ESC button.

To convert each stroke to a distance, the A2 needs an average length of a stroke. This is similar to a pedometer which uses

3.1.3 Sound settings

Next on the **Settings** menu listing is **Sound**. Press the SEL/ESC button to enter.

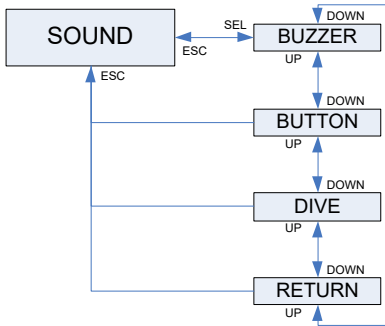

3.1.3.1 Buzzer

When delivered with factory settings the A2's buzzer is active. You can set the A2 to a stealth mode in the **Buzzer** submenu which deactivates all sounds. However, switching off all alarm sounds requires the safety code **313** to prevent accidental deactivation.

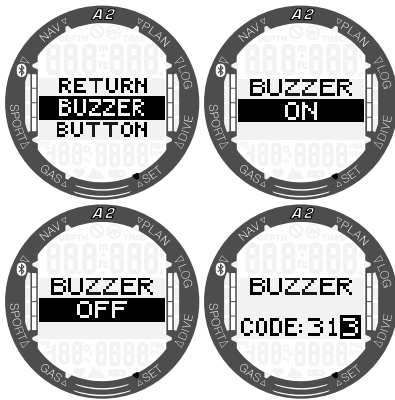

⚠ WARNING

Setting the "BUZZER OFF" will disable all audible dive mode alarms and warnings. This could potentially be dangerous.

3.1.3.2 Button beeps

In this submenu the general button feedback beeps can be enabled or disabled by pressing the +/UP or -/DOWN buttons followed by SEL/ESC to save the setting.

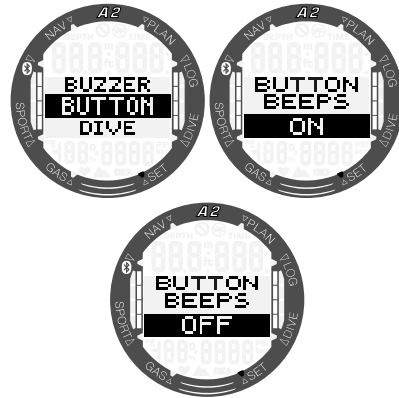

3.1.3.3 Dive warnings

In this submenu the warnings in dive mode can be enabled or disabled by pressing the +/UP or -/DOWN buttons followed by SEL/ESC to save the setting.

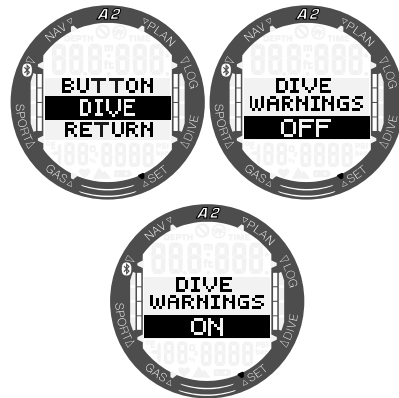

☞ **NOTE:** Dive alarms are still active even if you switch the dive warnings off. Dive alarms are deactivated only when the buzzer is switched off as described in chapter **3.1.3.1 Buzzer**.

3.1.4 Checking the battery status

When the menu **Battery** is selected, the A2 shows the last measured battery level.

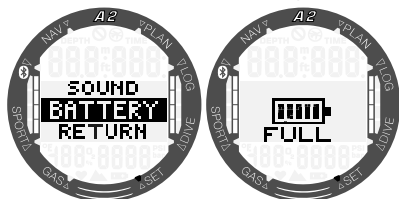

If you press the SEL/ESC button while in this menu, a new measurement will be made. This might take a few seconds. The A2 will display a “please wait” message until the revised battery status is available.

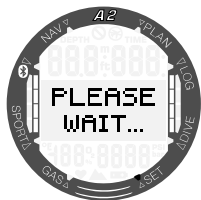

3.2 Dive settings on surface

From the main menu enter the **Dive** menu by pressing the SEL/ESC button.

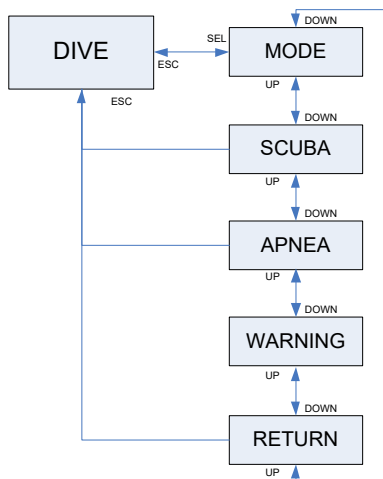

3.2.1 Dive mode selection

The **Mode** menu allows you to select your preferred dive mode: Apnea, Scuba or Gauge mode.

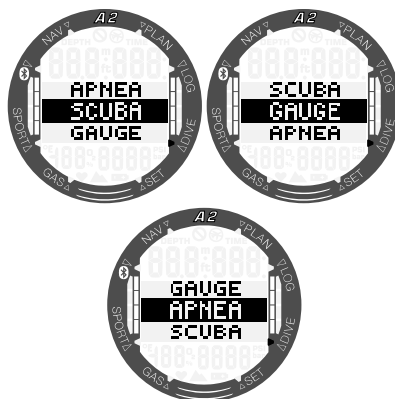
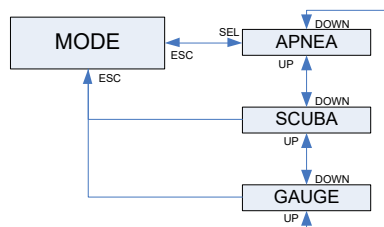

NOTE: The GAUGE and APNEA modes do not track tissue saturation so there is a locking interval before it is possible to change to SCUBA mode. In GAUGE mode the locking interval is 48h after the last dive in GAUGE mode. In APNEA mode there is a 12h locking interval with shallower than 5m/16ft dives, and a 24h locking interval with deeper than 5m/16ft dives.

3.2.2 Scuba mode settings

A set of SCUBA related selections are grouped in this menu.

By pressing the SEL/ESC button you can scroll through the following submenus:

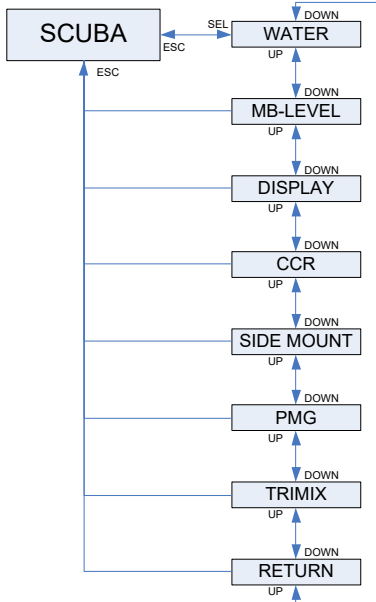

3.2.2.1 Water type selection

The A2 determines depth by measuring pressure using water density as a constant. A 10m/33ft depth in salt water corresponds approximately to 10.3m/34ft in fresh water. By pressing the +/UP or -/DOWN buttons you may select either salt or fresh water. The selection is confirmed by pressing the SEL/ESC button.

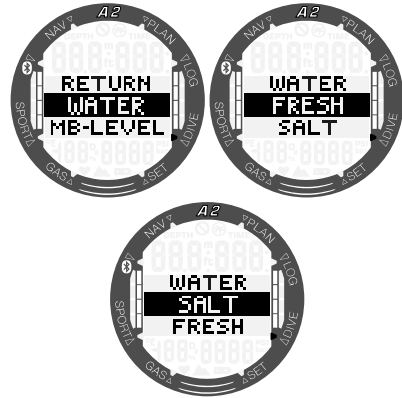

NOTE: This setting will adjust the depth on all modes: SCUBA, GAUGE and APNEA.

3.2.2.2 Microbubble level selection

By pressing the SEL/ESC button in this menu the Microbubble level will be highlighted. By pressing the +/UP or -/DOWN buttons you may select your personal setting from L0 up to L9.

L9 is the most conservative setting. The selection is confirmed by pressing the SEL/ESC button.

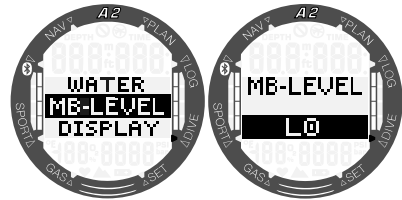

NOTE: More about diving with microbubble levels can be found in section 4.7 Diving with MB-levels.

3.2.2.3 Dive display type

In this menu the display type while diving in SCUBA and GAUGE modes can be selected. You will find a more detailed description about diving with light and classic displays in chapter 4.1.2.1 SCUBA mode display selection and 4.1.2.2 GAUGE mode display selection.

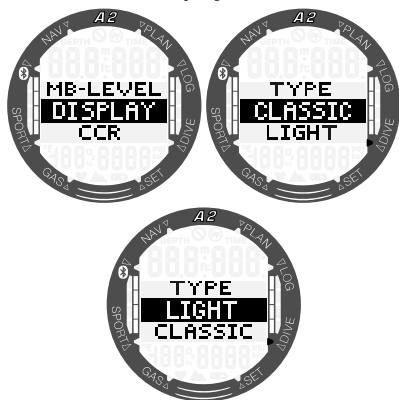

3.2.2.4 Enabling CCR mode

In order to enable the CCR mode, enter the main menu and go to Dive -> Scuba -> CCR and select "ON" by pressing the SEL/ESC button.

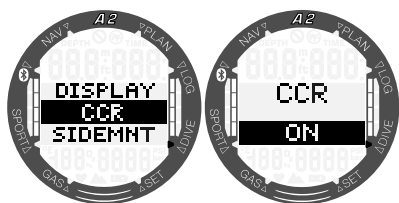

Enabling CCR changes the default open circuit gas content settings to setpoint settings.

Since the CCR dive unit is responsible for the setpoint accuracy and the A2 is using that accurate number, you can select some conservatism with an O₂ and inert gas correction (it is shown as N₂ but also influences He when the TMx option is enabled).

You can set the conservatism for both in the range from 0 up to 10% as shown in following screens.

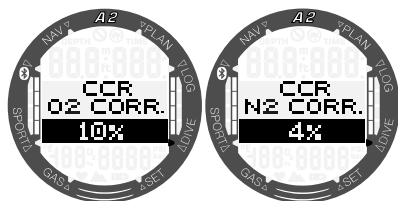

For example, the % value of the O₂ correction increases the nominally set ppO₂ value for the CNS% clock value and N₂ correction decreases the nominally set ppO₂ value for the inert gas absorption (algorithm).

NOTE: Activating sidemount or CCR diving modes will automatically enable the PMG mode. Refer to chapter 4.13 **Diving with CCR mode** to learn more about how the display is configured in this mode.

3.2.2.5 Enabling Sidemount mode

In order to enable the sidemount mode, enter the main menu and go to Dive -> Scuba -> Sidemnt and select "ON" by pressing the SEL/ESC button.

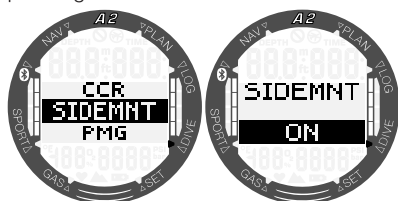

The pressure step defines the pressure difference between tanks when the A2 alerts you to switch from the lower to the higher supply side. You can choose a step between 10 and 50 bars or follow the rule of thirds.



☞ **NOTE:** Activating sidemount or CCR diving modes will automatically enable the PMG mode. Refer to chapter **4.14 Diving with Sidemount** mode to learn more about how the display is configured in this mode.

3.2.2.6 Enabling PMG mode

In order to enable the PMG mode, enter the main menu and go to **Dive -> Scuba -> PMG** and select “ON” by pressing the SEL/ESC button.

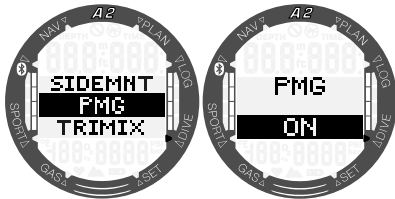

Predictive Multigas (PMG) mode enables the use of multiple tanks from 2 to 8. See chapter **4.15 Diving with multiple gas mixtures** to learn more about how to use this feature.

☞ **NOTE:** PMG must be enabled for sidemount and CCR diving modes.

3.2.2.7 Enabling Trimix mode

In order to enable the Trimix mode, enter the main menu and go to **Dive -> Scuba -> Trimix** and select “ON” by pressing the SEL/ESC button.

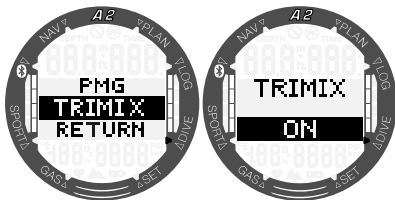

When Trimix is on, the gas content presentation follows the standard O₂/He. Also, the AMD (Absolute Minimum Depth) for each gas is shown. See chapter **4.16 Diving with Trimix mode** to learn more about this feature.

3.2.3 Apnea mode settings

Apnea diving-related selections are grouped in this menu.

By pressing the SEL/ESC button the following submenus can be accessed:

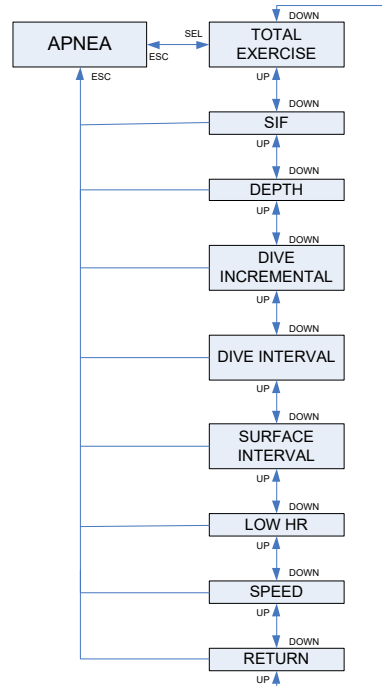

3.2.3.1 Total Apnea exercise depth

To provide a scale of total pressure changes during an Apnea dive session, the A2 includes a total depth counter. By pressing the +/UP or -/DOWN buttons you can set the total depth counter from 100m/300ft to 1000m/3301ft, and save the setting by pressing the SEL/ESC button. When your depth total has been reached the A2 notifies you at the surface with an audible tone and a blinking “no dive” symbol to let you know it’s time to end the session and take a break.

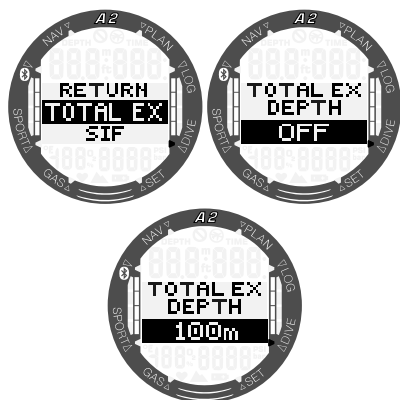

3.2.3.2 Surface interval factor

Apnea diving organizations provide various recommendations regarding surface intervals between dives based on dive times or depths. The A2 integrates a surface interval counter which employs simple multiplication for determining the surface interval in seconds. The A2 uses the following formula to make this calculation:

Surface interval before the next dive = pressure (depth) * square root of dive time * SIF.

As a reference, a few values are listed in the following table:

DIVE DEPTH		DIVE TIME	SURFACE INTERVAL	
m	ft	seconds	seconds (SIF = 5)	seconds (SIF = 20)
10	30	40	63	253
10	30	60	77	309
20	60	60	116	464
30	90	80	178	716
40	120	90	237	949

NOTE: The actual depth and time are calculated during the ascent and descent. This is not presented in the table above.

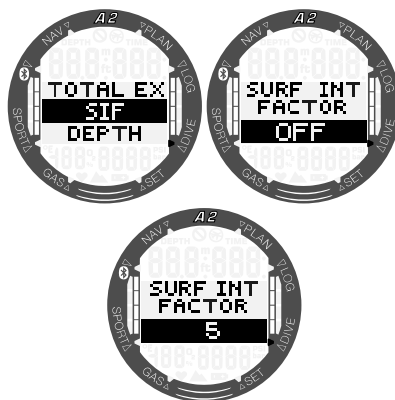

The SIF can be selected from 5 to 20 or disabled with the OFF setting by pressing

the +/UP or -/DOWN buttons and then the SEL/ESC button to save.

3.2.3.3 Dual depth alarm

In initial factory settings the dual dive depth alarm is switched off.

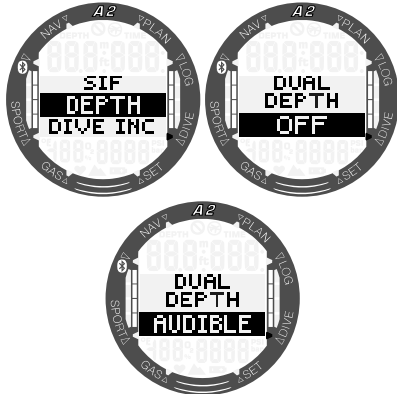

Once you have enabled this feature by selecting "AUDIBLE" in this menu, the first depth selection will be shown. By pressing the SEL/ESC button the A2 will display the second depth selection .

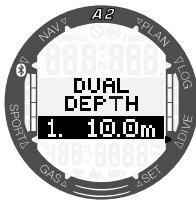

Both depth alarms can be set from 5 to 100 meters (20 to 330 feet) in 1m/5ft increments by pressing the +/UP or -/DOWN buttons. By pressing the SEL/ESC button the first value is confirmed and the second depth can be adjusted.

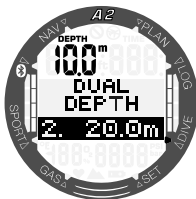

The value of the second alarm can be set the same way as that of the first alarm.

In the upper left section of the screen the depth of the first alarm is displayed.

NOTE: The first alarm is short sequence to get your attention, while the second alarm is continuous. By setting the first alarm deeper than the second, it will be masked by the continuous alarm and you may not be able to hear it.

3.2.3.4 Dive depth incremental alarm

In initial factory settings the dive depth incremental alarm is switched off.

You may select the alarm value from 5 to 100m (20 to 330ft) in 1m/5ft increments, and the direction can be selected as UP/DOWN/BOTH. Press the +/UP or -/DOWN buttons to select direction, then the SEL/ESC button, then the +/UP or -/DOWN buttons again to set the depth, followed by a final press of the SEL/ESC button to save the setting.

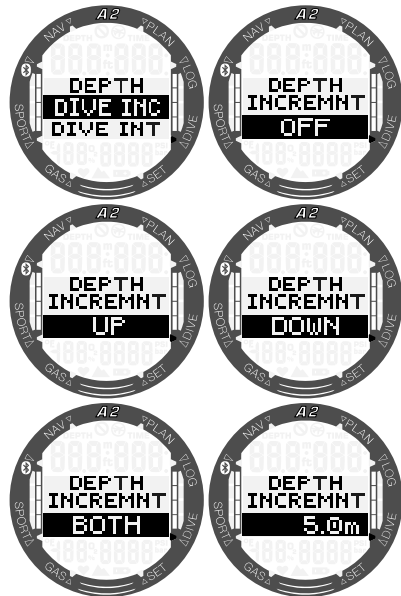

3.2.3.5 Dive time interval alarm

By pressing the SEL/ESC button the function will be highlighted and you may enable or disable the dive time interval alarm by choosing AUDIBLE or OFF by pressing the +/UP or -/DOWN buttons. By selecting AUDIBLE and then pressing the SEL/ESC button the time value will be highlighted, and by pressing the +/UP or -/DOWN buttons you can select the interval from 15 seconds up to 10 minutes in 15 second increments. By pressing the SEL/ESC button again the settings will be confirmed.

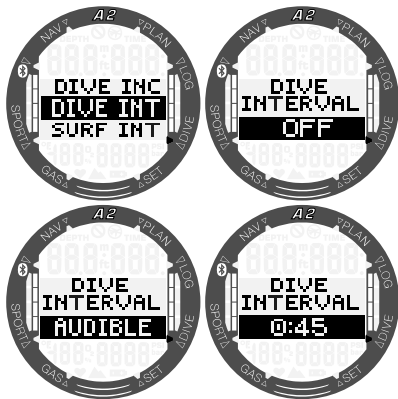

3.2.3.6 Surface interval alarm

By pressing the SEL/ESC button the function will be highlighted and you may enable or disable the surface interval alarm by choosing AUDIBLE or OFF by pressing the +/UP or -/DOWN buttons. By selecting AUDIBLE and then pressing the SEL/ESC button the time value will be highlighted, and by pressing the +/UP or -/DOWN buttons you can select the interval from 15 seconds up to 10 minutes in 15 second increments. By pressing the SEL/ESC button again the settings will be confirmed.

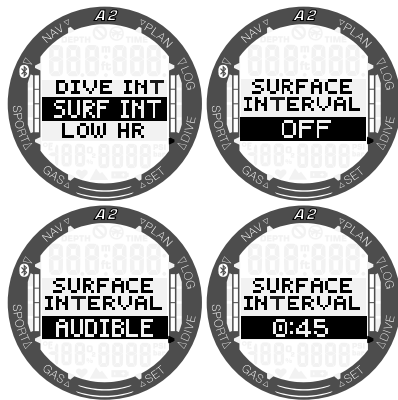

3.2.3.7 Low heart rate alarm

The A2 can trigger an alarm if your heart rate drops below a set level. The alarm can be set between 25 and 100 beats per minute.

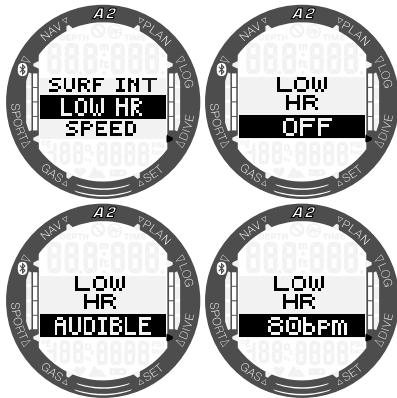

By pressing the SEL/ESC button the function will be highlighted and you may enable or disable the low heart rate alarm by choosing AUDIBLE or OFF by pressing the +/UP or -/DOWN buttons. By selecting AUDIBLE and then pressing the SEL/ESC button the value will be highlighted and by pressing the +/UP or -/DOWN buttons you can select the interval from 25 to 100. By pressing SEL/ESC again the settings will be confirmed.

3.2.3.8 Ascent speed alarm

By pressing the SEL/ESC button the function will be highlighted and you may enable or disable the ascent speed alarm by choosing AUDIBLE or OFF by pressing the +/UP or -/DOWN buttons. By selecting AUDIBLE and then pressing the SEL/ESC button the value will be highlighted, and by pressing the +/UP or -/DOWN buttons you can select the interval from 0.1 to 5.0 meters/second (1 to 15 feet/second) in 0.1m/sec or 1ft/sec increments. By pressing the SEL/ESC button again the settings will be confirmed.

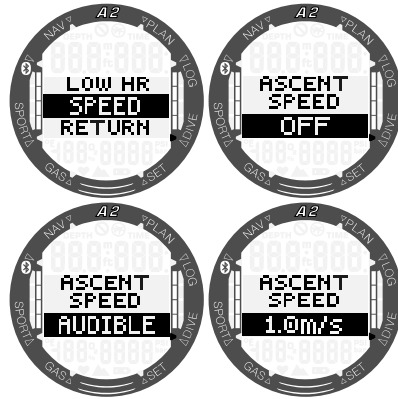

3.2.4 Warning settings

There are three warnings which can be enabled and edited directly in the A2. The rest of the warnings can only be enabled / disabled via SCUBAPRO LogTRAK program. To learn more about the warnings see chapter 4.4 Alarms and warnings during diving.

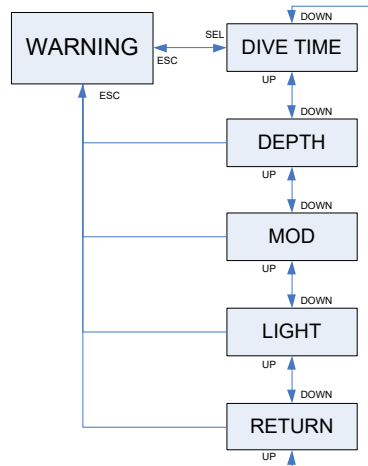

3.2.4.1 Setting the dive time warning

In initial factory settings the dive time warning is switched off. When you select dive time and switch the warning on, the value can be adjusted from 5 to 195 minutes in 5-minute increments by pressing the +/UP or -/DOWN buttons. The selection is confirmed by pressing the SEL/ESC button.

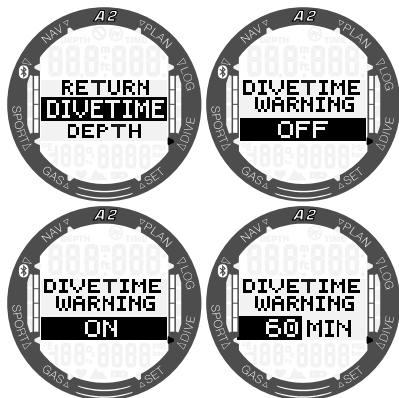

3.2.4.2 Setting the dive depth warning

In initial factory settings the dive depth warning is switched off. When you select dive depth and switch the warning on, the value can be adjusted from 5 to 100m (20 to 330ft) in 1m/5ft increments by pressing the +/UP or -/DOWN buttons. The selection is confirmed by pressing the SEL/ESC button.

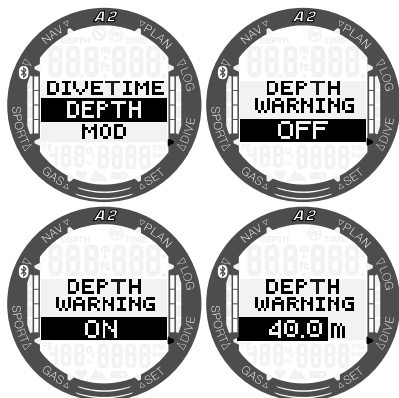

3.2.4.3 Setting the MOD alarm

In initial factory settings the MOD alarm is enabled. If the alarm is disabled, this requires the safety code 313 from the user to prevent accidental switching off.

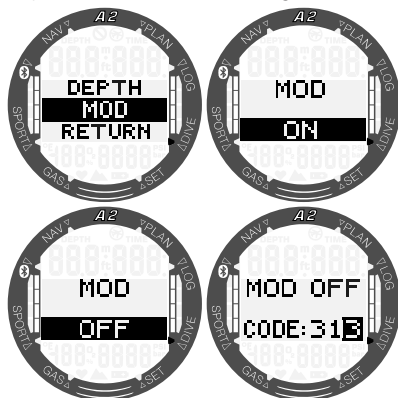

MOD alarm uses the maximum ppO₂ value which is given at the gas settings and the default value is 1.4bar.

⚠ WARNING

Diving at oxygen partial pressures higher than 1.6bar is extremely dangerous and could lead to serious injury or death

3.2.4.4 Setting the visual warning signal

In this menu you can enable or disable the A2's function of warning you with the lighting up of the display backlight in case a warning or alarm is triggered. This is an additional feature to the A2's audible warning signals, which can help make the diver aware of the presence of a warning in case the audible sequence would not be heard.

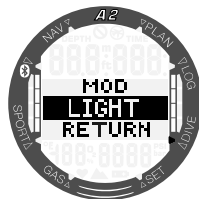

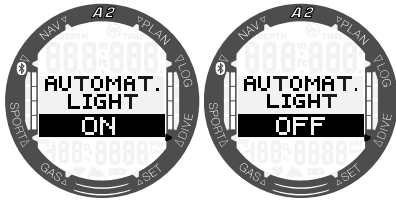

3.3 Gas settings

In this section gas related settings are described. From the main menu toggle down to the Gas menu and press the SEL/ESC button to enter.

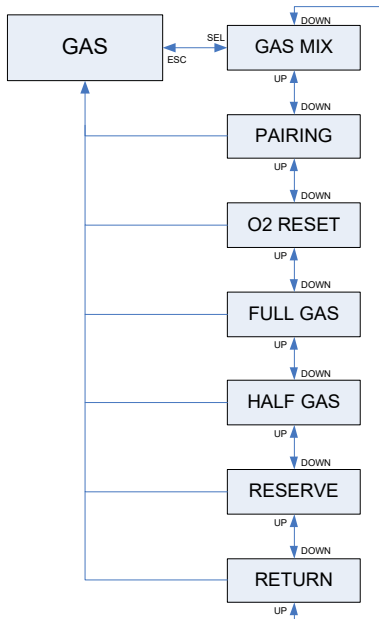

Here you can change the gas content of the tanks that you are using as well as the partial pressure limit of the gas. The Maximum Operating Depth (MOD) limit will be shown for the values that you have selected. To learn more about diving with Nitrox and MOD, see chapter **4.10 Diving with Nitrox**.

3.3.1 Setting gas oxygen content

For normal one-tank diving you can select a gas mix from 21% oxygen (Air) up to 100% oxygen. The ppO_2 max value is required for the MOD limit you intend to use for this gas. The factory setting is 1.40bar.

By pressing the SEL/ESC button in the **Gas mix** submenu the oxygen content of the gas will be highlighted. By pressing the +/UP or -/DOWN buttons you may set the value from 21% up to 100%.

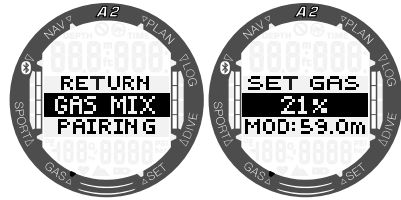

NOTE: Setting the gas mix will be disabled if the selected dive mode is Apnea or Gauge.

Once the oxygen content of a tank is confirmed by pressing SEL/ESC, the selection changes to ppO_2 limit value. By pressing the +/UP or -/DOWN buttons you may select a value from 1.00bar up to 1.60bar. A press of the SEL/ESC button will save the selection.

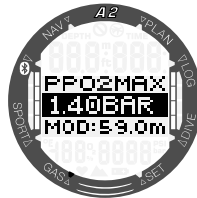

NOTE: If you cancel the ppO_2 setting by a press-and-hold of the SEL/ESC button, the oxygen content selection will also be canceled.

WARNING

Diving with a ppO_2 higher than 1.6bar is dangerous and may lead to unconsciousness, drowning and fatal injury.

☞ *NOTE: ppO_2 is fixed to 1.60bar when the selected oxygen content is 80% or higher.*

3.3.1.1 Predictive multi gas (PMG)

If PMG is enabled, up to 8 tanks can be preset and paired and the O_2 settings will appear as follows:

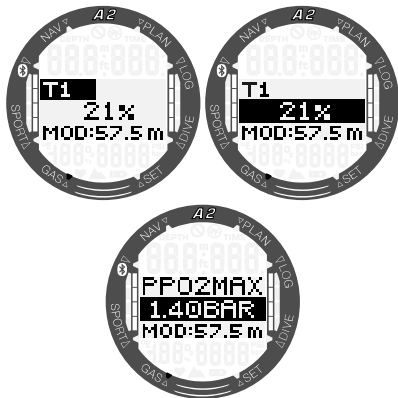

After selecting the tank (T1 in the picture above) and pressing the SEL/SEC button, the oxygen fraction can be edited. After confirming the oxygen fraction, you need to set the maximum ppO_2 value in the following screen. After confirming this with the SEL/ESC button, the tank is ready to be used.

T1 is always the default gas at the start of the dive. Other tank values (T2 to T8) can be configured the same way as Tank 1.

☞ *NOTE: You can set a different ppO_2 value for decompression gases than for bottom gases.*

☞ *NOTE: See chapter 3.2.2.6 Enabling PMG mode to learn how to enable this feature. For further information about diving with PMG mode, please refer to chapter 4.15 Diving with multiple gas mixtures.*

3.3.1.2 Trimix

When trimix mode is enabled the O_2 settings will appear as follows:

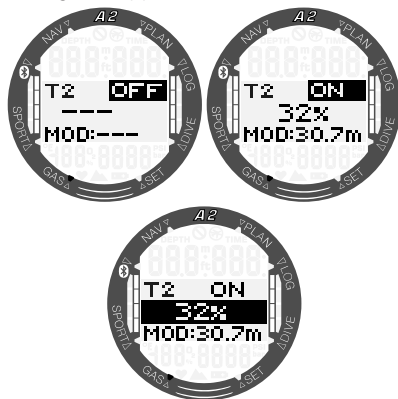

The tank selection works the same way as with PMG (T1-T8). First the selected tank's oxygen content has to be set, followed by the helium fraction.

☞ *NOTE: To ensure an adequate supply of oxygen to the body, the gas used at the beginning of the dive must contain enough oxygen. Since the dive always starts with tank T1, the minimum O_2 setting for tank T1 is 18%. For tanks T2 to T8 the minimum oxygen fraction is 8%.*

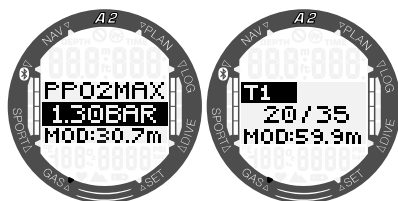

After the oxygen and helium contents are confirmed by pressing SEL/ESC, you have to set the maximum and minimum ppO_2 limits. The MOD (Maximum Operating Depth) and the AMD (Absolute Minimum Depth) are shown in the bottom row of these screens.

⚠ WARNING

The AMD depends on the ppO₂min value. If the alarm depth is shallower than 0.8m/3ft which is the dive start depth for the A2, the alarm will not activate before a 0.8m/3ft depth is reached! This situation is dangerous and may lead to death by drowning.

⚠ WARNING

Engaging in heavy work while at the surface or at shallow depths while breathing less than a 21% oxygen (hypoxic mix) fraction may cause a loss of consciousness and lead to drowning.

👉 **NOTE:** See chapter **3.2.2.7 Enabling Trimix mode** to learn how to enable this feature. For further information about diving with TMx mode, please refer to chapter **4.16 Diving with Trimix mode**.

3.3.1.3 CCR

If the CCR mode is enabled the diluent tank will appear as follows:

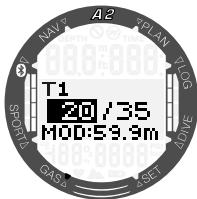

By pressing the SEL/ESC button in this screen the oxygen concentration of the diluent tank can be set in a range from 21% to 40%:

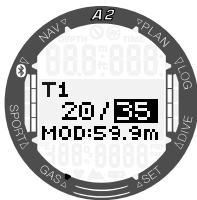

By pressing the SEL/ESC button, the tank content is confirmed and the dive start setpoint (SP1) ppO₂ will be highlighted. By pressing the +/UP or -/DOWN buttons you may select the value from 0.3bar up

to 0.95bar. By pressing the SEL button the given values are confirmed.

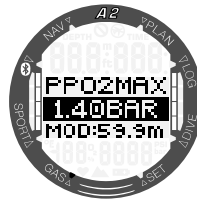

The bottom setpoint (SP2) has a range from 1.0bar up to 1.4bar ppO₂ and this is switched normally active on the way to the bottom or when the bottom depth is reached. SP2 is dedicated to the oxygen tank and the setting procedure is as with SP1.



👉 **NOTE:** See chapter **3.2.2.4 Enabling CCR mode** to learn how to enable this feature. For further information about diving with CCR mode, please refer to chapter **4.13 Diving with CCR mode**.

3.3.2 Mounting and pairing the high pressure transmitter

The A2 can receive tank pressure information from multiple Smart series high pressure transmitters. Each transmitter needs to be mounted on a high pressure port of a first stage regulator. To mount the transmitter, first remove the high pressure port plug from the first stage regulator, then screw the transmitter in place.

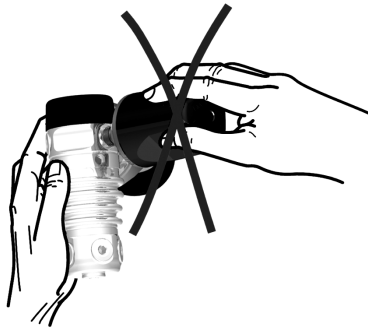
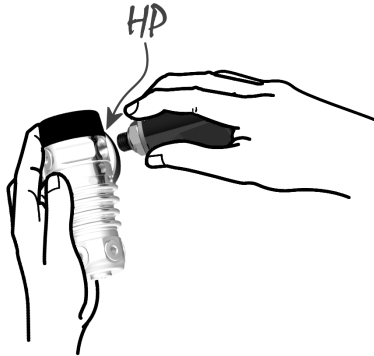

NOTE: Use an appropriate wrench to tighten the transmitter. Take care to not overtighten.

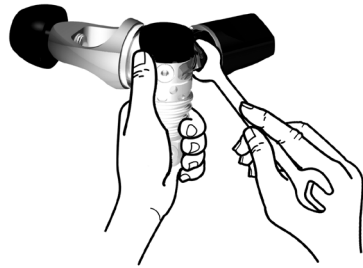

The Smart transmitter communicates via radio frequency with the A2. For optimal transmission performance, we recommend positioning the transmitter as described in the pictures below.

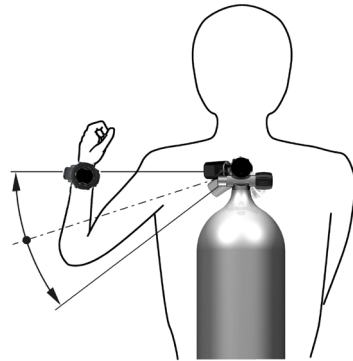

Transmitter position for the left hand.

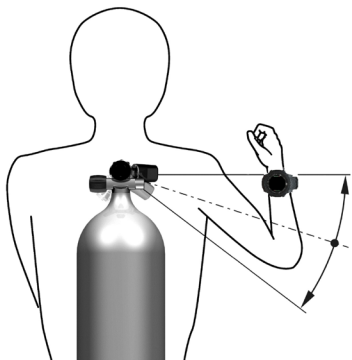

Transmitter position for the right hand.

In order for the A2 to display the pressure signal from a Smart transmitter, a coded, interference-free line of communication must first be established. This step needs to be performed only once for each transmitter.

Proceed as follows:

- Mount the first stage regulator with the Smart transmitter on a full tank.
- Set the A2 to pairing mode (**Gas -> Pairing**) and press SEL/ESC. The display shows "PAIR TANK". Place the A2 near the transmitter.
- Open the tank valve.

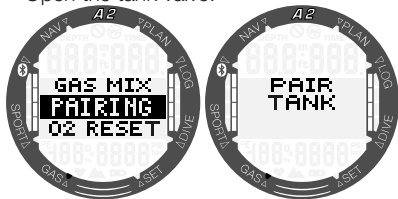

Upon pressurization, the Smart transmitter will send a pairing sequence to the A2. When the A2 receives this information, the display changes to show a listing of tank designations. (T1, T2, etc.).

Tank T1 is always the main tank you start your dive with. Other tanks are used when diving with more than one gas mixture described in chapter **4.15 Diving with multiple gas mixtures**.

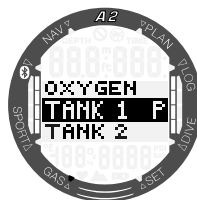

Use the +/UP or -/DOWN buttons to select the tank that you want to assign to the transmitter, then confirm it with a press of the SEL/ESC button. The current pressure of the paired tank will appear on the bottom row in either BAR or PSI.

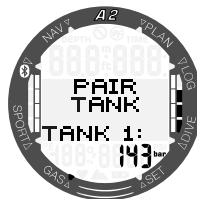

If the tank has not been paired, the A2 will show "nOP" instead of a pressure value. If T1 has been paired but the A2 is not receiving any signal, it will show - - - instead of a pressure value.

NOTE: The transmitter must have been unpressurized for at least 40 seconds prior to performing the pairing operation; otherwise it will not transmit the pairing sequence. A transmitter can only be paired to one tank designation. If you pair the same transmitter to a second tank designation, the first one will be erased. However, you can pair more than one A2 (or other compatible SCUBAPRO dive computers) to the same transmitter.

- ☞ **NOTE:** The Smart transmitter has a range of approximately 1.5m/5ft.
- To maximize the life of the battery, the transmitter operates at a low update rate when there is no pressure change for more than 40 seconds. The transmitter also turns itself off when the pressure is 14bar/200psi or less.
 - If a transmitter battery is weak, the A2 will alert you with a screen message displaying the tank assigned to that transmitter as shown on the screen below (T1 batt).



See chapter **7.5 Replacing the battery in the high pressure transmitter** for information on how to replace the transmitter's battery.

3.3.3 Nitrox reset time

If you are generally diving with air and want to return to this setting after the occasional nitrox dive, you can preset a default time when your A2 will set back to air.

By pressing the SEL/ESC button the time shown on the bottom row will be highlighted. The time can be selected from 1 hour up to 48 hours by pressing the +/UP or -/DOWN buttons. The nitrox reset time can be disabled by pressing the +/UP or -/DOWN buttons until -- h is shown on the display. A press of the SEL/ESC button will save the setting.

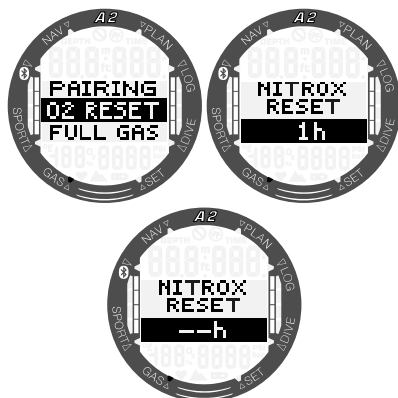

3.3.4 Full gas

The analog bar graph on the right side of the display indicates the selected tank pressure when this is enabled (ON). To scale the graph you need to select the maximum (full) tank pressure. This can be set from 100 to 300 bar.

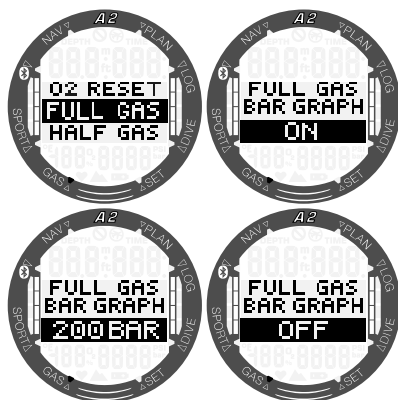

3.3.5 Setting the half tank warning

By pressing the SEL/ESC button the status ON/OFF will be highlighted. You can enable the half gas warning by selecting "ON" and disable it by selecting "OFF". By activating the half gas warning the pressure value will be highlighted and you may set a value from 50 to 200bar in 5-bar increments (749..2999psi in 50-psi increments) by pressing the +/UP or -/DOWN buttons. By pressing SEL/ESC you confirm the settings.

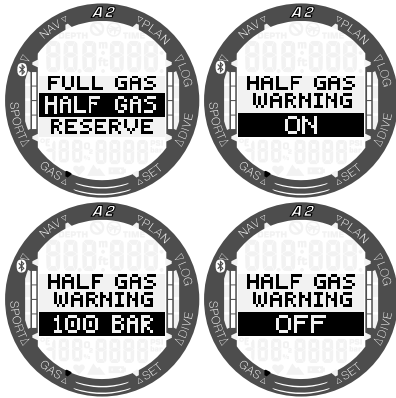

3.3.6 Setting the tank reserve alarm

By pressing the SEL/ESC button the pressure value will be highlighted and you may set a value from 20 to 120bar in 5-bar increments (299..1749psi in 50-psi increments) by pressing the +/UP or -/DOWN buttons. Pressing the SEL/ESC button will confirm the settings.

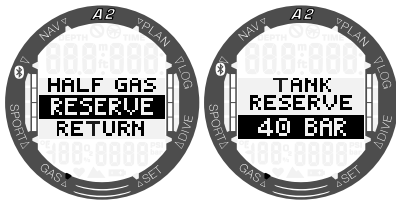

NOTE: Reaching the tank reserve pressure triggers an alarm. In the RBT calculation the tank reserve pressure is defining the complete used tank. The reserve pressure should still be in the tank when surfacing

3.4 Planning a dive

You can plan your next dive based on your body's nitrogen saturation. The planner is also using the following information:

1. Selected oxygen concentration.
2. Selected water type.
3. Selected microbubble level.
4. Water temperature of the most recent dive.
5. Altitude range.
6. Status of saturation at the time when the planner is activated.
7. Observance of the prescribed ascent rates.

To set up a new dive plan, scroll to the planner menu and press SEL/ESC.

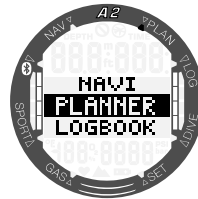

3.4.1 No-stop plan

If you have completed a dive but plan to make another during the desaturation phase, you must start the planner by adding the time you would otherwise be on the surface. The time can be added in 15-minute increments.

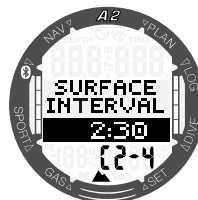

The prohibited altitude class is shown after the current elevation at the bottom line. For more information on altitude diving with the A2, see chapter: **4.9 Altitude diving**. In case the A2 is displaying the no-dive warning, the duration of the warning itself is displayed as a recommended surface interval for planning purposes (rounded up to the nearest 15-minute increment).

When the surface interval is given, or if you have no remaining desaturation left, the planner can show depth in 3m/10ft increments and scrolled by pressing +/UP or -/DOWN. The no-decompression dive time is shown for that depth. The current gas mix is shown on the bottom row.



CNS% value replaces the gas mix on the bottom left of the screen when 1% would be reached for that depth with maximum no-stop time.



NOTE: The minimum depth for dive planning is 9m/30ft. The planner allows only depths in line with maximum ppO_2 . The oxygen content and maximum ppO_2 settings are given in the menu **GAS**.

If the MOD is shallower than 9m/30ft, planning is not allowed and the A2 will show "**MOD: LOW**".

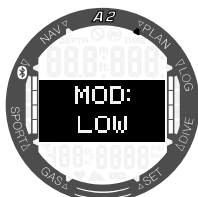

3.4.2 Decompression plan

After confirming the planned dive depth with the SEL/ESC button, the planned dive time can be set by pressing the +/UP or -/DOWN buttons.

In the below image the planned dive time is minimum 17 minutes.

The start point (17 minutes) is the "no decompression" time. The deepest decompression or MB-level stop is also shown as well as the Total Ascent Time.



NOTE: When the A2 is in GAUGE or APNEA modes, the Planner is disabled and this is indicated by a display like the following:

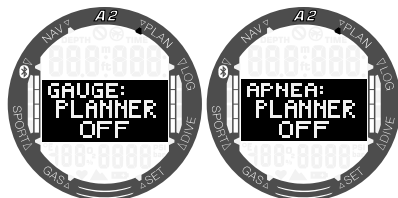

3.5 Reading the logbook

You can review your dive and step counter statistics by pressing the SEL/ESC button when in the **Logbook** menu.

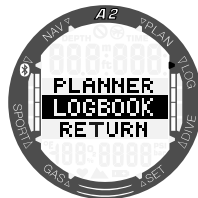

3.5.1 Dive statistics

Enter the Dive submenu from the Logbook menu to view your dive statistics.

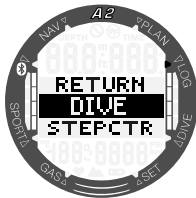

On the display below, the A2 has 11 dives and total of 6 hours of diving in the Logbook, with the deepest dive at 57.0 meters and a longest dive time of 80 minutes.



By pressing the SEL/ESC button you will enter the repository of the logs where you can scroll through your dives with the +/UP or -/DOWN buttons. The below display shows the following information: Dive number, dive mode, dive start time and date.

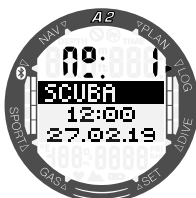

By pressing the SEL/ESC button on the above screen the A2 will display the graphical profile of the dive. This screen shows the following information: Maximum depth, total duration of the dive, minimum temperature of the water, active heart rate function and the tank pressure.



By pressing the +/UP button on the above screen the following information will appear as in the screen below:

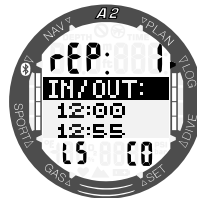

Counted repetitive dive (rep 1 is the first dive), start and finish time, microbubble level (L5) and the altitude class (CO) of the dive. By pressing +/UP in the above screen the tank information of the selected dive will be displayed:



NOTE: The capacity of the A2's logbook is around 50 hours with a 4-second sampling rate.

3.5.2 Step counter statistics

Enter the **Stepctr** (Stepcounter) submenu from the Logbook menu to view your step counter statistics.

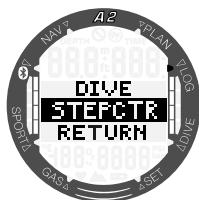

With the +/UP and -/DOWN buttons you can scroll through your daily, weekly and monthly step counter statistics.

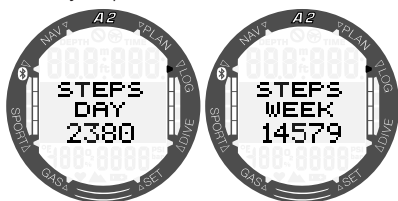

4. DIVING WITH THE A2

The A2 is a full-featured diving computer capable of multi-gas Nitrox decompression calculations, CCR mode, ascent rate calculations and warnings. During a dive the A2 displays information such as depth, dive time, decompression status, water temperature, tank information, true remaining bottom time and much more. On the surface after a dive, remaining desaturation time, no-fly time, surface interval and prohibited altitude classes are shown in addition to the watch functions.

Note that the A2 can be set to three dive modes: SCUBA, APNEA and GAUGE. Due to the operational differences between modes, the buttons will have different functions depending on which mode you are using.

The functions of the buttons **during diving** are summarized in the table below:

"LIGHT"	Press = backlight Press-and-hold = launch compass
"SEL/ESC"	Press-and-hold in Apnea mode when in "surface interval" display = end Apnea exercise Press = set bookmark
"+/UP"	Press = scroll through alternative dive displays Press-and-hold in GAUGE mode when average depth on display = reset average depth counter Press-and-hold in GAUGE and SCUBA mode when timer on display = stop/restart the timer
"-/DOWN"	Press = scroll through alternative dive displays Press-and-hold in Apnea mode when in "surface interval" display = end Apnea exercise Press-and-hold in GAUGE and SCUBA mode when timer on display and stopped = reset timer to zero

4.1 Display information

Upon immersion, the A2 will automatically start to monitor the dive regardless of what state it was in prior to the immersion. Details on the information displayed can be found in the next sections.

Dive time: the dive time is displayed in seconds in APNEA mode and in minutes in SCUBA and GAUGE modes. If during the dive you ascend to the surface, the time spent on the surface will only be counted to the dive time if you descend again below 0.8m/3ft within 5 minutes. This allows for brief periods of orientation. While on the surface, the time will not show as progressing but it is running in the background. As soon as you submerge, the time will resume, including the time spent on the surface. If you spend more than 5 minutes at a depth shallower than 0.8m/3ft, the dive will be considered ended, it is stored in the logbook and a subsequent immersion would cause the dive time to start again from zero.

Maximum displayed time is 999 minutes. For dives longer than that, the dive time starts again from 0 minutes.

Depth: the depth is displayed in 0.1m resolution when the metric system is set. When depth is displayed in feet, the resolution is always 1 foot. Maximum operating depth is 120m/394ft.

No-stop time: calculated in real time and updated every 4 seconds. The maximum displayed no-stop time is 199 minutes.

WARNING

During all dives, perform a safety stop between 3 and 5 meters/10 and 15 feet for 3 to 5 minutes, even if no decompression stops are required.

The following chapter describes the SCUBA mode diving functions, if you are using GAUGE or APNEA dive modes, these are further described in chapters **4.11 Diving in GAUGE mode** and **4.12 Diving in APNEA mode**.

4.1.1 Dive ready mode

A press-and-hold of the -/DOWN button in the main time and date display will give you access to the dive ready mode which shows you your current dive settings. Information like dive mode, current MB-level, water type selection, MOD, gas oxygen content and tank pressure will be displayed as follows:

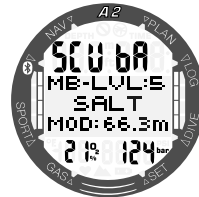

After a dive there are further displays which can be shown by pressing the -/DOWN button. These displays can identify for example the no-dive time (10h), no-fly time (2h), surface interval (0:06), repetitive dive number (1) and current & prohibited altitude classes (03).

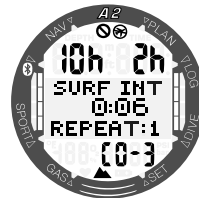

By a further press of the -/DOWN button the no-dive time (10h), no-fly time (2h), and remaining desaturation time (13:50) will be shown.



4.1.2 Display configuration during the dive

Throughout the dive, the A2 displays depth and dive time always at the top row of the screen. Gas mix and the water temperature are shown at the bottom row. The information in the middle of the screen changes and it is also selectable by pressing the +/UP or -/DOWN buttons.

4.1.2.1 SCUBA mode display selection

In SCUBA mode you can choose from two display versions while diving: Light or Classic. The following screens illustrate the information in the middle of the screen which can be selected as shown in the sections below.

 **NOTE:** The default information in the middle of the screen at the beginning of the dive is the No-Stop Time. If you select another information in the middle of the screen, there is no timeout to the default except when decompression limit is reached. Decompression time and depth are appearing in the middle of the screen after 3 minutes from any other selected screen.

4.1.2.1.1 Light version



No-Stop Time, which is the time that can be spent at current depth before decompression stops are required.



Current depth is shown in feet or full meters without a comma. This is the larger duplicate of the top row depth.

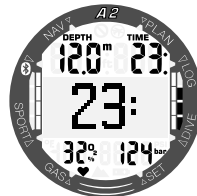

Elapsed Dive Time, this is a larger duplicate of the top row dive time.



Tank pressure

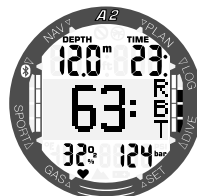

Remaining Bottom Time



Gas Oxygen Content, this is a larger duplicate of the bottom row O₂% value.

4.1.2.1.2 Classic version



No-Stop Time



Remaining Bottom Time



Current MB-level



Heart rate



Current time of the day



Timer



Water temperature



Skin temperature



Maximum depth reached during current dive



Decompression stop

4.1.2.2 GAUGE mode display selection

In GAUGE mode you can choose from two display versions while diving: Light or Classic. The following screens illustrate the information in the middle of the screen which can be selected as shown in the sections below.

NOTE: When the A2 is set to GAUGE mode, it will only monitor depth, time, and temperature, and it will not carry out any decompression calculations. Due to this there are fewer alternative displays to scroll through.

4.1.2.2.1 Light version



Timer



Current depth



Elapsed dive time



Average depth



Tank pressure

4.1.2.2.2 Classic version



Timer



Average depth



Maximum depth reached during the current dive



Current time of the day



Heart rate

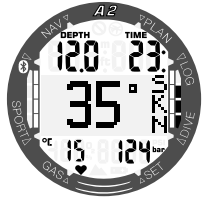

Skin temperature

 **NOTE:** The average depth can be reset by a press-and-hold of the +/UP button when it is active on the screen.

NOTE: In Gauge and Scuba mode when the timer is displayed, it can be stopped by a press-and-hold of the +/UP button. A repeated press-and-hold of the +/UP button will restart the timer. When the timer is stopped, it can be reset to zero by pressing and holding the -/DOWN button.

4.1.2.3 APNEA mode

If the Apnea mode is triggered manually by selecting **Apnea** in the **Sport** menu, the surface interval starts counting in the middle of the display without previous dive information (depth is - - - at the top and repetitive dive count is 0 at the bottom row) as in the screen below:

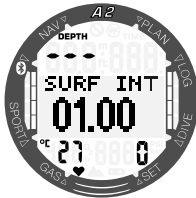

However, after an immersion the surface screen shows the last max depth, surface interval, water temperature and amount of repetitive dives during the APNEA session.

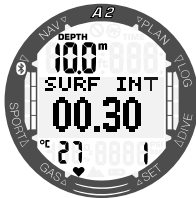

From the surface interval display by pressing the +/UP button you can scroll through the following displays:

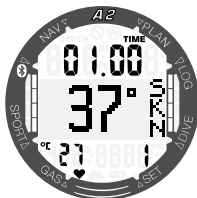

Skin temperature



Heart rate



Total time of current Apnea dive session

After the second immersion, by scrolling through the Apnea dive displays with the +/UP or -/DOWN buttons, the following additional information will be displayed:



Duration of last immersion

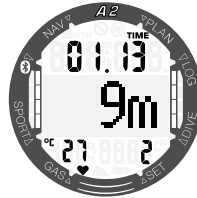

Maximum depth reached during last immersion

During an immersion in Apnea mode these four screens show the current dive depth and duration as well as the current heart rate and skin temperature values and they can be scrolled through by pressing the +/UP or -/DOWN buttons.

NOTE: The dive depth displayed in large size in the middle part of the screen is shown with no decimal values rounded up or down, but the actual depth is always precisely saved and shown in the logbook with 0.1m/1ft accuracy.

4.2 Safety stop timer

If a minimum depth of 10m/30ft is reached during the dive, at a depth of 5m/15ft the safety stop timer will automatically start a 3-minute countdown. If you go below 6.5m/20ft, the timer will disappear and the no-stop time will be shown again. Upon returning to 5m/15ft, the timer will start again automatically.



4.3 Activating the backlight

To activate the backlight, press the LIGHT button. For setting the duration of the backlight refer to chapter 3.1.1.2 **Backlight**.

 **NOTE:** The backlight is not available when the CHANGE BATTERY warning appears.

4.4 Alarms and warnings during diving

The A2 can alert you to potentially dangerous situations via warnings and alarms. You can modify the warning and alarm settings in the menus or via the LogTRAK interface.

General warnings and alarms are shown in inverted text (white with black background) in the middle of the display. Additionally, audible signals are available when the sound function is enabled. You can also set a visual warning function, where the A2's display backlighting would indicate if an alarm or warning was triggered. If this feature is enabled, the backlight will light up for the duration of the respective warning. Refer to chapter 3.2.4.4 **Setting the visual warning signal** to learn how to enable this feature. Warnings are shown for 12 seconds or they can be confirmed

by pressing the SEL/ESC button which changes the alarm display back to the normal dive display. However, if the warning condition continues, the warning can be recalled by scrolling with the +/UP or -/DOWN buttons. Alarms can also be confirmed by pressing the SEL/ESC button, but they remain on the alternate display which can be scrolled through with the +/UP or -/DOWN buttons.

WARNING

When in Gauge mode, all warnings and all alarms are OFF except for the low battery, tank reserve, half tank, max depth, max dive time and pressure signal alarms.

When the A2's buzzer is disabled all audible alarms and warnings are muted but will still appear on the display if triggered.

4.4.1 Maximum depth warning

If you have enabled the maximum depth warning, the below display will be shown when the selected depth is reached. Refer to chapter 3.2.4.2 **Setting the dive depth warning** to learn how to enable this warning.



4.4.2 MOD (ppO₂max) alarm

If you exceed the maximum partial pressure of the selected gas, the following alarm is shown: MOD + DEPTH. The alarm remains active until you ascend to a depth where the ppO₂ is within safe limits.



⚠ WARNING

The MOD should not be exceeded. Disregarding the alarm can lead to oxygen poisoning. Exceeding a ppO₂ of 1.6bar can lead to sudden convulsions resulting in serious injury or fatal issue.

4.4.3 AMD (ppO₂min) alarm

When diving with multiple gas mixtures at shallower depths than the AMD for the current gas mix, the absolute minimum depth alarm will be triggered. For more information about the AMD refer to chapter 4.16.1 Absolute Minimum Depth and Maximum Operating Depth.

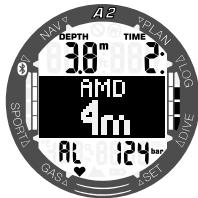

⚠ WARNING

The AMD depends on the ppO₂min value. If the alarm depth is shallower than 0.8m/3ft which is the dive start depth for the A2, the alarm will not activate before a 0.8m/3ft depth is reached! This situation is dangerous and may lead to death by drowning.

4.4.4 Dive time warning

If you have enabled the dive time warning, this will be shown by a screen like the below when the selected time is reached. Refer to chapter 3.2.4.1 Setting the dive time warning to learn how to enable this warning.



4.4.5 Turning time

When dive time warning is activated the A2 will alert you when it's time to turn around and start ascending to the surface.

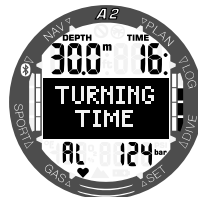

4.4.6 No-stop time = 2 minute warning

If you wish to avoid unintentionally performing a decompression dive, the A2 can activate a warning when the no-stop time reaches 2 minutes. This applies to both L0 no-stop and MB no-stop time (see chapter 4.7 Diving with MB-levels for more information on MB-level diving). It gives you the opportunity to start ascending before incurring a decompression stop or a level stop obligation.



4.4.7 No-stop time warning

The A2 can activate a warning when the first mandatory decompression stop appears. This alerts you to the fact that a direct ascent to the surface is no longer possible.



4.4.8 CNS O₂ warning (over 75%)

The A2 tracks your oxygen uptake via the CNS O₂ clock. If the calculated value of CNS O₂ reaches 75%, the A2 will emit a sequence of audible beeps for 12 seconds and the following display will be shown.



4.4.9 CNS O₂ alarm (100%)

The A2 tracks your oxygen uptake via the CNS O₂ clock. If the calculated value of CNS O₂ reaches 100%, the A2 will emit a sequence of audible beeps for 12 seconds and the CNS 100% alarm will be shown.



⚠ WARNING

When the CNS O₂ reaches 100% there is danger of oxygen toxicity. Start the procedure to terminate the dive.

4.4.10 L0 no-stop time = 2 minute warning

When diving with an MB-level higher than L0, the underlying L0 information is not directly visible on the display (though it is accessible as alternate information). You can choose to have your A2 warn you when the underlying L0 no-stop time reaches 2 minutes while diving with an active MB-level higher than L0.



4.4.11 Entering decompression warning

The A2 can activate a warning when the first mandatory decompression stop appears. This alerts the diver to the fact that a direct ascent to the surface is no longer possible. This warning applies to dives with the computer set to L0-L9.



4.4.12 Missed decompression stop alarm

If in the presence of a required decompression stop you ascend more than 0.5m/2ft above the required stop, the A2 will indicate an alarm: MISSED DECO. This will continue for as long as you stay 0.5m/2ft or more above the required stop.



⚠ WARNING

Violating a mandatory decompression obligation may result in serious injury or fatal issue.

4.4.13 MB-level stop ignored

When diving with an MB-level higher than L0 and in the presence of MB-level stops, the A2 can warn you if you reach a depth shallower than the deepest required MB-level stop, therefore allowing you to avoid missing the required stop.



4.4.14 MB-level reduction warning

When diving with an MB-level higher than L0 and in the presence of MB-level stops, if you ascend more than 1.5m/5ft above the deepest required MB-level stop, the A2 reduces your MB-level to the next possible level. The display will show the new active MB-level. You can set your A2 to warn you when this happens.



4.4.15 Ascent rate alarm

The A2 employs a variable ideal ascent rate. Its value ranges from 3 to 10m/min (10 to 33ft/min) and the actual breakdown by depth range is listed in the table below.

DEPTH		ASC SPEED	
m	ft	m/min	ft/min
0	0	3	10
2.5	8	5.5	18
6	20	7	23
12	40	7.7	25
18	60	8.2	27
23	75	8.6	28
31	101	8.9	29
35	115	9.1	30
39	128	9.4	31
44	144	9.6	32
50	164	9.8	32
120	394	10	33

If you ascend too quickly, the resulting pressure reduction could lead to microbubble formation. If you ascend too slowly, the continued exposure to high ambient pressure means you will continue loading some or all of your tissues with nitrogen.

If the ascent rate is greater than 110% of the ideal value, the SLOW DOWN alarm is shown.

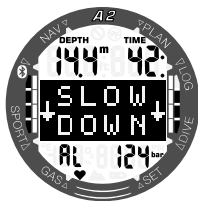

4.4.16 SOS

If you stay above a depth of 0.8m/3ft for more than 3 minutes without observing a mandatory decompression stop, the A2 will switch into SOS mode. Once in SOS mode the A2 will lock up and will be inoperable as a dive computer for 24 hours. If it is used for diving within the 24 hours of an SOS lock, it will automatically switch to gauge mode and provide no decompression information.



SOS in Gauge mode



SOS in Scuba mode

⚠ WARNING

Violating a mandatory decompression obligation may result in serious injury or fatal issue. Serious injury or fatal issue may result if a diver does not seek immediate treatment should any signs or symptoms of decompression sickness occur after a dive.

Do not dive to treat symptoms of decompression sickness.

Do not dive when the computer is in SOS mode.

4.4.17 Low battery alarm

During the dive A2 will alert you if the battery level is getting critically low. This means you need to start the procedure to terminate the dive, as there is not enough energy in the battery to ensure the proper functions and the computer may fail. Some functions like backlight and audible alarms are no longer available.

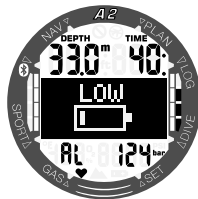

⚠ WARNING

Do not start a dive if the battery symbol is blinking on the watch mode. The computer may fail to function during the dive and this could lead to serious injury or fatal issue.

4.4.18 Pressure signal

If the A2 receives no signal from the transmitter for 70 seconds, an audible sequence goes off and the message BAD SIGNAL appears on the display for 12 seconds. After 30 seconds without receiving signal the A2 emits another audible sequence and the message SIGNAL LOST appears on the display, after which the tank pressure is replaced with - - -.

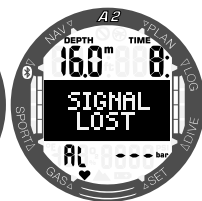
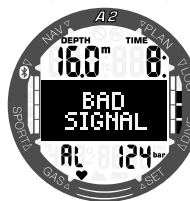

⚠ WARNING

In the event of a "signal lost" situation, all tank pressure-related information on the A2 ceases to be valid. In such a case, you must use a backup instrument for pressure monitoring and seek a safe ascent to the surface. Running out of gas under water is dangerous and may lead to severe injury or death by drowning.

4.4.19 RBT = 0 min

If the amount of bottom time you have left at your current depth reaches 0, the following alarm will be triggered:

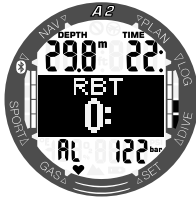

In the event of a “signal lost” situation, all tank pressure-related information on the A2 ceases to be valid. In such a case, you must use a backup instrument for pressure monitoring and seek a safe ascent to the surface. Running out of gas under water is dangerous and may lead to severe injury or death by drowning.

4.4.20 Half tank warning

If you have enabled the half tank warning, the below display will be shown when the selected tank pressure is reached. Refer to chapter 3.3.5 **Setting the half tank warning** to learn how to enable this warning.



4.4.21 Tank reserve alarm

Reaching the preset tank reserve pressure triggers an alarm. In the RBT calculation the tank reserve pressure is defining the complete used tank. The reserve pressure should still be in the tank when surfacing.



NOTE: Refer to chapter 3.3.6 **Setting the tank reserve alarm** to learn how to enable this feature.

4.5 No-Dive warning

If the A2 detects a situation of increased risk (due to potential microbubble accumulation from previous dives or a CNS O₂ level above 40%), the **NO DIVE** symbol will appear to advise you against performing another dive right away. The suggested time interval that you should wait prior to diving again is shown in the top left section of the dive mode display.

You should not undertake a dive as long as the no-dive warning is displayed on the computer screen. If the warning is prompted by microbubble accumulation (as opposed to CNS O₂ over 40%) and you dive anyway, you will have shorter no-stop times or longer decompression times. Moreover, the duration of the microbubble warning at the end of the dive can increase considerably.

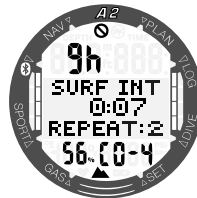

4.6 No-Fly time

The no-fly time is the time during which an exposure to the reduced pressure (equal to ascending at higher altitudes) inside the cabin of an airplane could cause decompression sickness, as calculated by the decompression model in the computer. The no-fly symbol with countdown timer is shown in the top right section of the dive mode display until the restriction is completed.



4.7 Diving with MB-levels

Microbubbles are tiny bubbles that can build up inside a diver's body during a dive and normally dissipate naturally during an ascent and on the surface after a dive. Dives within no-stop times or the observance of decompression stops do not prevent the formation of microbubbles in the venous blood circulation.

Dangerous microbubbles are those migrating into the arterial circulation. The reasons for the migration from the venous blood circulation to the arterial circulation can be because of a build-up of microbubbles collecting in the lungs. SCUBAPRO has equipped the A2 with technology to help protect divers from these microbubbles.

With the A2 you can choose – according to your specific needs – a MB-level that will provide a level of protection from microbubbles. Diving with MB-levels includes additional ascent stops which slow the ascent process, giving the body more time to desaturate. This works contrary to the formation of microbubbles and may increase safety.

The A2 features 10 microbubble levels (L0-L9). Level L0 corresponds to SCUBAPRO's well-known decompression model ZH-L16

ADT PMG and does not require additional stops due to microbubble formation. Levels L1 to L9 offer additional protection from microbubble formation, with level L9 offering the highest level and most protection.

Similar to the display of information during decompression dives or dives within no-stop time, the A2 displays the depth and duration of the first level stop as well as the total time of ascent as soon as the MB no-stop time has run out. As the MB no-stop time is shorter than the ordinary no-stop time, you will be required to perform a stop sooner than a diver using level L0.

If you ignore a required stop, the A2 will simply step down to a lower MB-level. In other words, if you choose level L8 prior to the dive, and during the dive you ignore the L8's recommended stops, the A2 will automatically adjust the setting to level L7 or lower.

Comparison of dives with MB-level L0 and level L9:

When two A2 dive computers are used simultaneously, with one unit set to a MB-level of L9 and the other to a MB-level of L0, the no-stop time for the L9 unit will be shortened and more stops will be required before the L9 diver has the same obligation of a decompression stop as the L0 diver. These additional stops help dissipate microbubbles.

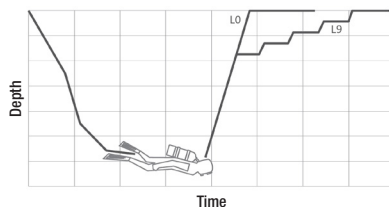

4.8 PDIS (Profile Dependent Intermediate Stop)

4.8.1 Introduction to PDIS

The main purpose of a dive computer is to track your nitrogen uptake and recommend a safe ascent procedure. Diving within the so-called no-stop limits means that at the end of the dive you can ascend directly to the surface, albeit at a safe ascent rate, while for dives outside of the no-stop limit (so-called decompression dives), you must perform stops at certain depths and allow time for excess nitrogen to be expelled from your body before finishing the dive and re-surfacing.

In both cases, it can be beneficial to stop for a few minutes at an intermediate depth between the maximum attained depth during the dive and the surface or, in case of a decompression dive, the first (deepest) decompression stop.

An intermediate stop of this kind is beneficial as soon as the ambient pressure at that depth is low enough to ensure that your body is predominantly off-gassing nitrogen, even if under a very small pressure gradient. In such a situation, you can still cruise along the reef and enjoy the dive while your body gets a chance to slowly release nitrogen.

In recent times, so-called “deep” stops have been introduced in some dive computers and tables, defined as half the distance from the dive’s maximum depth and the surface (or the lowest decompression stop). Spending 2 or 15 minutes at 30m/100ft would result in the same deep stop at 15m/50ft.

With PDIS, as the name suggests, the A2 interprets your dive profile and suggests an intermediate stop that is a function of your nitrogen uptake so far. The PDI stop will therefore change over the course of the dive to reflect the continuously changing situation in your body. Along the same lines, PDIS will account for the accumulated nitrogen from previous dives; hence, PDIS is also repetitive-dive dependent. Conventional deep stops completely ignore these facts.

The following figure quantifies the extent of PDIS and illustrates its dependence on cumulative nitrogen uptake for 2 sample dive profiles. This figure also demonstrates the conceptual difference between PDIS and the rather rudimentary “deep” stops. Specifically, the figure compares 2 dive

profiles to a maximum depth of 40m/132ft that are otherwise very different.

Profile 1 stays at 40m/132ft for 7 minutes, then ascends to 30m/100ft for 3 minutes, followed by 12 minutes at 20m/65ft. Profile 2 stays less than 2 minutes at 40m/132ft, then ascends to 21m/69ft and stays there for 33 minutes. Both dive profiles are no-stop dives to the limit of entering decompression.

The solid line represents the PDIS depth as displayed on the computer screen during the course of the dive for profile 1, the broken line represents the PDIS depth as displayed on the computer screen during the course of profile 2. One can see that the displayed PDIS depth increases as more nitrogen is accumulated in the body, but does so very differently in the 2 dives due to the different exposure in the 2 profiles. The PDI stop is carried out at 25 minutes for profile 1 and at 37 minutes for profile 2, followed by the safety stop at 5m/15ft.

The line made up of small solid dots, on the other hand, represents the depth that would be displayed by a computer following the conventional deep stop method, and it would be the same for the 2 dive profiles. Deep stops completely ignore any facts about the dives themselves aside from max depth.

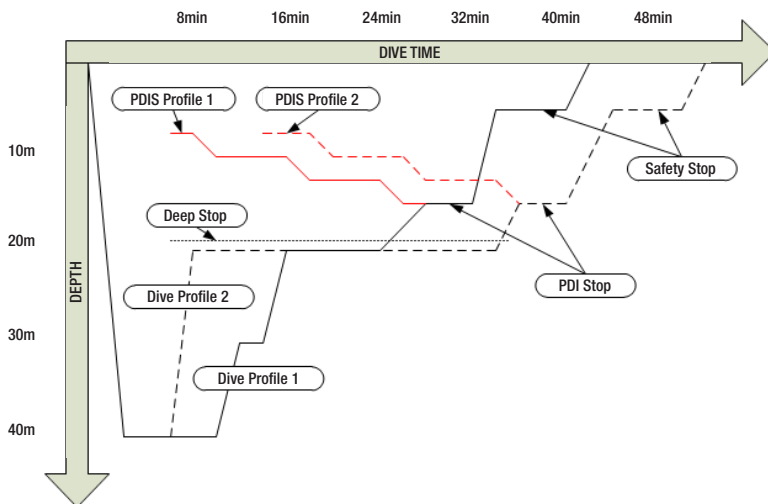

4.8.2 How does PDIS work?

The mathematical decompression model in the A2, called ZH-L16 ADT MB PMG, tracks your decompression status by dividing your body into 16 so-called compartments and mathematically following the uptake and release of nitrogen in each with the appropriate laws of physics. The various compartments simulate parts of your body such as central nervous system, muscles, bones, skin and so on.

The depth of the PDI stop is calculated as that at which the leading compartment for the decompression calculation switches from on-gassing to off-gassing, and the diver is advised to perform a 2-minute stop above the displayed depth (this is the opposite of a decompression stop, where you are asked to remain just beneath the displayed depth). During this intermediate stop, the body is not taking up any more nitrogen in the leading compartment, but rather releasing nitrogen (though under a very small pressure gradient). This, combined with the relatively high ambient pressure, inhibits bubble growth. It should be noted that the 4 fastest compartments, up to 10-minute half-times, respectively, are not considered for the determination of the PDI stop depth. This is due to the fact that these compartments are only “leading” for

very short dives, for which an intermediate stop is not required at all.

 **NOTE:** The PDI stop is not a mandatory stop, and it is NOT a substitute for the 3- to 5-minute safety stop at 5m/15ft.

WARNING

Even when performing a PDI stop, you still **MUST** perform a safety stop at 5m/15ft for 3 to 5 minutes. Performing a 3- to 5-minute stop at 5m/15ft at the end of any dive remains the best thing you can do for yourself.

4.8.3 Diving with PDIS

When the calculated PDI stop is deeper than 8m/25ft, the A2 shows it on the display and continues to do so until you reach the displayed depth during an ascent. The displayed value changes during the dive as the A2 tracks the uptake of nitrogen in the 16 compartments and updates the PDIS depth accordingly to reflect the optimum at all times.



During a no-stop dive, as soon as you reach that depth during an ascent, a 2-minute countdown will appear.



You can have one of these 3 situations:

- You have spent 2 minutes within 3m/10ft above the indicated depth. The countdown timer disappears and you have successfully completed the PDIS.
- You have descended more than 0.5m/2ft below the PDIS. The countdown timer disappears and will reappear again, starting at 2 minutes, the next time you ascend to the PDIS depth.
- You have ascended more than 3m/10ft above the PDIS. The PDIS value and countdown timer disappears and PDIS has not been performed.

NOTE: The A2 issues no warnings relating to a missed PDI stop. When diving with MB-levels, PDIS follows the same rules as described above. MB-levels, however, introduce stops earlier and deeper than the L0 base algorithm. As such, the PDIS display may be delayed and, for certain dives, it may not be displayed at all. This, for example, would be the case for a shallow dive with air (21% oxygen) and a MB-level L5.

4.9 Altitude diving

4.9.1 Altitude warning after a dive

Climbing to altitude is similar to starting an ascent from a dive: you expose your body to a lower partial pressure of nitrogen and you start off-gassing. After a dive, given the higher nitrogen loading in your body, even reaching an otherwise negligible altitude can potentially cause decompression sickness. Consequently, the A2 constantly monitors the ambient pressure and uses it to evaluate your nitrogen loading and off-gassing. If the A2 notices a drop in ambient pressure not compatible with your current nitrogen loading, it will activate a warning (altitude symbol starts blinking) to alert you of a potentially dangerous situation.

The A2 counts down remaining saturation and indicates this on the “dive ready mode” screen with the no-fly time until the available saturation is no longer dangerous during a flight or when crossing over a mountain pass.

The allowable altitude (beyond which the A2 has computed to be incompatible with your current nitrogen saturation levels) is displayed below the no-fly time and the surface interval. Refer to chapter **2.3.2 Reading the altitude, barometric and temperature values** for more information.

4.9.2 Altitude and the Altitude and the decompression algorithm

Atmospheric pressure is a function of altitude and weather conditions. This is an important aspect to consider for diving, because the surrounding atmospheric pressure has an influence on on-gassing and off-gassing of nitrogen in your body. The A2 divides the possible altitude range into 5 classes that are illustrated in the picture below:

Altitude Class	Elevation	Barometric switch point	Dive computer mode
C4	4000 m 13120 ft	610 mbar 8.85 psi	GAUGE (no deco data)
C3	3000 m 9840 ft	725 mbar 10.51 psi	SCUBA
C2	2000 m 6560 ft	815 mbar 11.82 psi	SCUBA
C1	1000 m 3280 ft	905 mbar 13.13 psi	SCUBA
C0	0 m 0 ft		SCUBA

The altitude classes are approximate elevations because the effect of weather conditions can make the switch point pressure occur at different levels.

WARNING

At the altitude class 4 or higher the A2 operates in GAUGE mode only (the mode will switch automatically).

 **NOTE:** A fast descent from mountains or a fast rise in airplane cabin pressure may activate the dive mode. The A2 will automatically detect and end this "dive" after 12 hours, or you may manually activate the check by a press-and-hold of both +/UP and -/DOWN buttons at the same time. This kind of false dive will not be stored in the A2 logbook.

 **NOTE:** You can check your current altitude class and elevation in the **Altimtr** menu.

 **NOTE:** The A2 deals with altitude automatically - it monitors the atmospheric pressure every 60 seconds and if it detects a sufficient drop in pressure, it does the following: it indicates the new altitude range and, if applicable, the prohibited altitude range; it indicates the desaturation time, which in this case is an adaptation time to the new ambient pressure. If a dive is started during this adaptation time, the A2 considers it a repetitive dive since the body has residual nitrogen.

4.9.3 Prohibited altitude

Going to altitude, as well as flying after diving, exposes your body to a reduced ambient pressure. In a manner similar to no-fly time, the A2 advises you of the safe altitudes you can reach after a dive, and those which are not safe. If you have to drive over a mountain pass to return home after a dive, this information can be quite important and you can check this information in the planner.

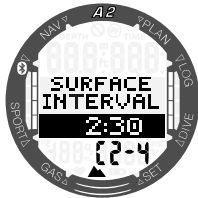

The current altitude class is shown in the middle on the bottom row and the prohibited altitude is shown on the right. In the example above, the diver is presently at altitude class 2 and should not reach altitudes above 4000m (class 4) within the given interval of 2 hours and 30 minutes. By increasing the interval time on the middle row the allowed altitude increases due to the desaturation caused by the time spent at the current altitude class.

⚠ WARNING

If atmospheric pressure is below 610mbar (altitude higher than 4000m/13300ft), no decompression calculation is carried out by the A2, and it will not start in SCUBA mode, but in GAUGE mode. In addition, the dive planner is not available at this altitude.

4.9.4 Decompression dives in mountain lakes

In order to ensure optimal decompression even at higher altitudes, the 3m/10ft decompression stage is divided into a 2m/7ft stage and a 4m/13ft stage in altitude ranges 1, 2 and 3.

If atmospheric pressure is below 610mbar (altitude higher than 4000m/13300ft), no decompression calculation is carried out by the A2 (automatic GAUGE mode). In addition, the dive planner is not available in this altitude class.

4.10 Diving with Nitrox

Nitrox is the term used to describe breathing gases made of oxygen-nitrogen mixes with the oxygen percentage higher than 21% (air). Because nitrox contains less nitrogen than air, there is less nitrogen loading on the diver's body at the same depth as compared to breathing air.

However, the increase in oxygen concentration in nitrox implies an increase in oxygen partial pressure in the breathing mix at the same depth. At higher than atmospheric partial pressures, oxygen can have toxic effects on the human body. These can be grouped into 2 categories:

1. Sudden effects due to oxygen partial pressure over 1.4bar. These are not related to the length of the exposure to high oxygen partial pressure. Sudden effects can vary and depend on the exact level of partial pressure they happen at. It is commonly accepted that partial pressures up to 1.4bar are tolerable during the active part of the dive, and maximum oxygen partial pressures up to 1.6bar during the decompression.
2. Long exposure effects to oxygen partial pressures over 0.5bar due to repeated and/or long dives. These can affect the central nervous system and cause damage to lungs or to other vital organs. Long exposures can be divided between more severe Central Nervous System effects and less dangerous long-term Pulmonary Toxicity effects. The A2 treats high ppO₂ and long exposure effects in the following ways:

Against sudden effects: The A2 has an MOD alarm set for a user-defined ppO_2 max. As you enter the oxygen concentration for the dive, the A2 shows you the corresponding MOD for the defined ppO_2 max. The default value of ppO_2 max from the factory is 1.4bar. This can be adjusted to your preference between 1.0 and 1.6bar. It can also be turned off. Please refer to chapter **3.3.1 Setting gas oxygen content** for more information on how to change this setting.

Against long exposure effects: The A2 “tracks” the exposure by means of the CNS O_2 clock. At levels of 100% and higher there is risk of long exposure effects, and consequently the A2 will activate an alarm when this level of CNS O_2 is reached. The A2 can also warn you when the CNS O_2 level reaches 75%. Note that the CNS O_2 clock is independent of the value of ppO_2 max set by the user. CNS O_2 75% warning and CNS O_2 100% alarm can be activate during a dive (see chapters **4.4.8 CNS O_2 warning (over 75%)** and **4.4.9 CNS O_2 alarm (100%)** for more information), whereas the remaining CNS O_2 value after a dive is shown in the “ready to dive” display in the left side of the bottom row (in the below display this is 56%).



The CNS O_2 clock increases when the oxygen partial pressure is higher than 0.5bar, and decreases when the oxygen partial pressure is lower than 0.5bar. Hence, while on the surface breathing air you will always be decreasing the CNS O_2 clock. During the dive, the depth at which 0.5bar is reached for various mixes is as follows:

Air: 13m/43ft

32% O_2 : 6m/20ft

36% O_2 : 4m/13ft

NOTE: For oxygen concentrations of 80% and higher, the ppO_2 max is fixed at 1.6bar and cannot be changed.

4.11 Diving in GAUGE mode

When the A2 is set to GAUGE mode, it will only monitor depth, time, and temperature, and will not carry out any decompression calculations. You can only switch to GAUGE mode if the computer is completely desaturated. All audible and visual warnings and alarms, other than the low battery, max depth and max dive time are turned off.

WARNING

Dives in GAUGE mode are performed at your own risk. After a dive in GAUGE mode you must wait at least 48 hours before diving using a decompression computer.

When on the surface in GAUGE mode, the A2 will show neither the remaining desaturation time nor the CNS O_2 % value. It will, however, display a surface interval up to 24 hours and a 48-hour no-fly time. This no-fly time is also the time during which you cannot change the dive mode.



The GAUGE mode surface display after a dive shows the dive time in the top row. In the middle row the timer is running from the dive start or last manual restart. In the bottom row the water temperature is shown. After a 5-minute timeout the display changes to GAUGE mode ready to dive menu.

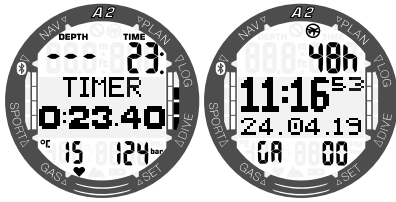

During a dive in GAUGE mode, the A2 displays depth and dive time at the top row, a timer in the middle and water temperature at the bottom row. The timer can be paused and restarted by a press-and-hold of the +/UP button. When the timer is paused, it can be reset to zero by pressing-and-holding the -/DOWN button. The alternative displays in the middle can be scrolled through by pressing the +/UP or -/DOWN buttons.

 **NOTE:** For more information about the configuration of the dive displays in GAUGE mode, please refer to chapter 4.1.2.2 GAUGE mode display selection.

4.12 Diving in APNEA mode

The A2 measures the depth in APNEA mode every 0.25 seconds to ensure the precise maximum depth. In the logbook the data is saved in 1-second intervals. In APNEA mode it is also possible to start and stop the dive manually with a press-and-hold of the -/DOWN button. This way you can use the A2 for static Apnea dives, where a normal dive start depth of 0.8 meters will not start a new dive.

Apnea mode at the surface after an immersion shows the maximum depth, water temperature and the amount of repetitive dives. The surface interval is counted in the middle of the screen.



By pressing the +/UP or -/DOWN buttons from the surface interval display the skin temperature (37°C) and the heart rate values (115 bpm), the maximum depth (4m) and duration (01.13 min) of the last dive and the total duration of the current Apnea exercise (00:04) are shown.

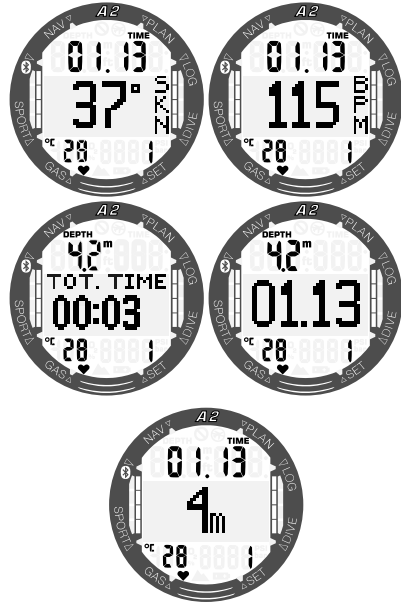

The displays during the dive in Apnea mode show skin temperature, heart rate values, current dive time, depth, water temperature and number of repetitive dives of the current session.

The alternative displays in the middle can be scrolled through by pressing the +/UP or -/DOWN buttons.

The displays in APNEA mode are the following:

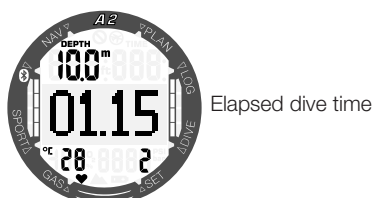

Elapsed dive time

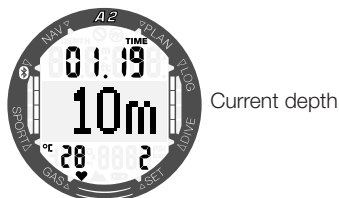

Current depth



Skin temperature



Heart rate

As with Gauge mode, the A2 in Apnea mode doesn't carry out any decompression calculations. You can only switch to APNEA mode if the computer is completely desaturated. Also the A2 is locked in the APNEA mode for 12 hours after shallower than 5m dives and after deeper dives the lock period is 24 hours.



4.13 Diving with CCR mode

The CCR (Closed Circuit Rebreather) system is probably older than the Open Circuit SCUBA system because the basic operating principle with manual control didn't require a highly reliable regulator system. The CCR system also uses the gas more efficiently than an open loop system, because the oxygen is added to the breathing loop only as needed. Respectively, the carbon dioxide generated by the body is bound to calc at the scrubber. As a side effect the CCR system is nearly bubble-free, which can be beneficial when engaged in photography or observing fishes underwater. In the CCR system the breathing gas ppO_2 (partial pressure of the oxygen) is kept constant. The CCR system itself takes care of this. Compared to an open loop system the constant ppO_2 converts to a variable nitrox mix at different depths. For example, a ppO_2 setting of 1.0bar is comparable to an open loop 50% nitrox mix at a depth of 10 meters in salt water.

⚠ WARNING

All rebreathers require unit specific education before using them. Get the proper certifications and follow manufacturer recommendations and procedures when diving with a rebreather unit. Deviations may lead to severe injury or death.

In CCR mode the display information shows the ppO_2 setpoints (SP1 and SP2) and the oxygen concentration of the tanks T1-T8. You can scroll through these displays with the +/UP or -/DOWN buttons. The lower left section of the display shows the O_2 value of the diluent tank and in the upper section of the display the current depth and the elapsed dive time are shown. To manually access the displays in CCR mode, press-and-hold the SEL/ESC button.

☞ NOTE: To confirm a switch from SP1 to SP2 (or the other way around), press SEL/ESC in the respective screen.

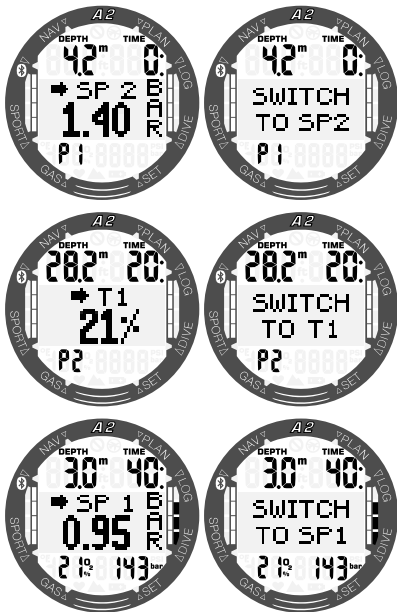

If the switch between SP1 and SP2 was not successful, the A2 will display the following message:



The SP switch depth is suggested by the dive computer the same way the gas switches are suggested in open circuit mode (predictive gas switching). The switch points are determined by the equivalent oxygen contents in open circuit mode. So, the switch point is reached on the way down when the equivalent content of the gas at that depth reaches the diluent O₂ level. For example, with a SP1 of 0.5bar of the air diluent the depth would be approximately 13.8m/45.3ft in salt water.

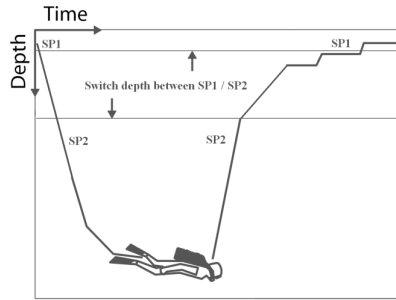

Diving in CCR mode

4.14 Diving with Sidemount mode

In sidemount diving there are normally two tanks and two regulators, each set mounted independently on each side of the diver.

Independent redundant gas delivery systems should be drawn down equally, in small steps, so in case one system fails the other system has maximum reserves to complete the dive. When the A2's sidemount mode is enabled (ON) and the switching pressure is defined (see chapter 3.2.2.5 **Enabling Sidemount mode**), the two tank pressures screen can be selected during the dive in the middle of the screen and it looks like the following display:

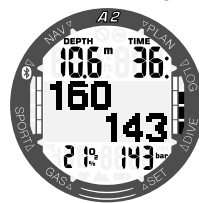

When the selected pressure difference (in the situation below 20 bar) between the tanks is reached, A2 is proposing to switch to the higher pressure tank.



Confirm the tank switch with a press of the SEL/ESC button.

The active tank pressure is always shown in the bottom right corner of the display.

When the tank with the higher pressure is selected, there is no arrow indicator for the switch.

☞ **NOTE:** For proper operation of the sidemount mode, both tanks must be equipped and paired with a transmitter.

☞ **NOTE:** The Sidemount mode can be used for backmount independent twin tank diving as well.

4.15 Diving with multiple gas mixtures

The A2 is equipped with the ZH-L16 ADT MB PMG algorithm. PMG stands for Predictive Multi Gas, meaning that when you program more than one gas mixture, the A2 will predict the switch to the higher oxygen concentration gas at the depth that you specified and alert you at all times with a comprehensive decompression schedule of all the gas mixtures that you programmed.

In other words, you get full credit at any point during the dive for all the extra gas mixtures that you are carrying with you.

☞ **NOTE:** See chapter **3.2.2.6 Enabling PMG mode** to learn how to enable this mode on your A2

⚠ WARNING

VERY IMPORTANT!

- Diving with multiple gas mixtures represents a much higher risk than diving with a single gas mixture, and mistakes by the diver may lead to serious injury or death.
- During dives with multiple gas mixtures, always make sure you are breathing from the tank that you intend to use. Breathing from a high oxygen concentration mix at the wrong depth can kill you.
- Mark all your regulators and tanks so that you cannot confuse them under any circumstances.
- Before each dive and after changing a tank, ensure that each gas mixture is set to the correct value for the corresponding tank.
- Get the proper training and certifications to make multi-gas dives prior to making them by yourself.

The A2 enables you to use up to 8 gas mixtures during the dive.

- For oxygen concentrations of 80% and higher, the ppO_2 max is fixed at 1.6bar and cannot be changed.
- The MOD for tanks 2 through 8 are the switch depths for those gases. This is what the A2 uses for its calculations, warnings and suggested switch points.
- When diving with more than 1 gas mixture, the nitrox reset time function (described in the chapter **3.3.3 Nitrox reset time**) has the following effect: gas1 is set to 21% gases 2 through 8 are set to OFF.

⚠ WARNING

Start breathing from the tank with the new gas mixture before confirming a switch. Always make sure you are switching to the intended gas. Failure to do so may result in serious injury or death.

The following sections about gas switching are shown with 2 gas mixtures enabled. However, more than two mixes enabled are working similarly.

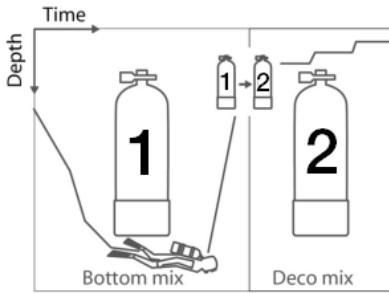

Diving with 2 gas mixtures

4.15.1 Switching gas mixture during the dive

During the ascent phase, when you reach a depth corresponding to the MOD of a gas other than the one you are currently using, the A2 will suggest that you perform the switch. An audible sequence is played, and the message **-> T2** (and its O₂ content) appears on the display. You have 30 seconds to respond to this message; otherwise, the A2 will conclude that gas 2 will not be used and adapt the decompression schedule accordingly.



To confirm the gas switch, press the SEL/ESC button. After confirming the switch, the message **SWITCH TO T2** remains on the screen for approximately 5 seconds.

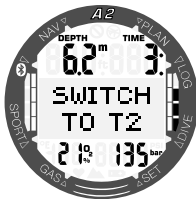

4.15.2 Switching back to a gas mixture with lower oxygen concentration

There may be situations where you have to switch back to a tank with lower oxygen concentration. This can happen, for instance, if you want to descend again below the MOD of the higher oxygen concentration gas (T2), or if you have run out of T2 gas during decompression. At this point you can manually initiate the gas switch by pressing-and-holding the SEL/ESC button.

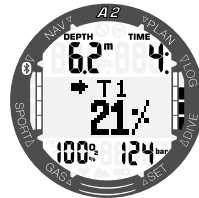

The A2 will display the message **-> T1** and its O₂ concentration. Press the SEL/ESC button to confirm the switch or press +/UP to select a different gas mixture.

4.15.3 Gas switch not carried out at the planned depth

If you fail to confirm the gas change within the 30 seconds of when the A2 suggests it, the gas is excluded from the decompression calculation and the decompression schedule is adapted accordingly, basically reflecting the fact that you will finish the dive without using the excluded gas.

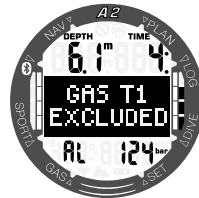

4.15.4 Delayed gas switch

You can catch up on a planned gas mixture switch at any time by selecting the gas manually. Press-and-hold the SEL/ESC button to start the gas switch procedure. The A2 will display for example -> **T2** and its oxygen concentration. This helps you verify that you are performing a switch to a safe gas. At this point you would press the SEL/ESC button to confirm the switch. The A2 will display the message **SWITCH TO T2** and adapt the decompression schedule accordingly.

4.15.5 Submerging below the MOD after a gas switch

If after having switched to gas T2 you inadvertently drop again below the MOD for that mixture, the MOD alarm will immediately be activated. In this case, you would either switch back to gas T1 or ascend above the MOD for gas T2.

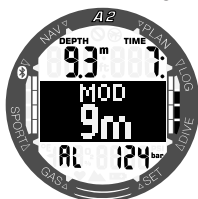

4.16 Diving with Trimix mode

⚠ WARNING

VERY IMPORTANT!

⚠ When breathing compressed air or EAN Nitrox during a dive, the diver accepts a certain level of risk. When breathing a Trimix gas or other mix gases during a dive, the risk level increases.

⚠ We have used all relevant data and the most recent hyperbaric research on Trimix diving to bring the risk level of our Trimix algorithm to the lowest possible acceptable level. Nevertheless, we can in no way guarantee that breathing Nitrox, Trimix, mixed gases or compressed air during a dive using our Trimix algorithm will eliminate or prevent the risk of serious injury or death from decompression sickness, oxygen toxicity or some other inherent risk.

⚠ The Trimix diver using our Trimix algorithm on our dive computers should be aware of the risk level and be willing to accept that personal risk and bear the full legal responsibility of such risks. If the diver is not willing to accept those risks, including serious injury or death, then he or she should not dive with our Trimix mode.

⚠ Never risk your life on only one source of information. Eventually, every computer has the potential to fail, so do not depend exclusively upon it and always have a plan for how to handle failures. Use a redundant dive computer, carry backup tables and depth/time instrumentation. If you make riskier dives, obtain the proper training from a recognized agency to gain the required technical skills and experience needed for this type of diving. Computer technology is never a substitute for knowledge and training.

⚠ WARNING

Before performing trimix dives with the A2 you should practice no-stop recreational diving to become accustomed to the interface and functions of the dive computer.

4.16.1 Absolute Minimum Depth and Maximum Operating Depth

Absolute Minimum Depth (AMD) and Maximum Operating Depth (MOD) are calculated from the oxygen content in the mix. The ppO_2 that is given by the user is divided by the oxygen fraction. The result will be pressure, which is converted to depth. The MOD is valid for all gases, while the AMD is only applicable to a gas mix where the oxygen fraction is less than air.

☞ *NOTE: Air (21/0) gives a different MOD than, for example, trimix 21/10. The reason is, the A2 uses a more precise value for the oxygen in the air, which is 20.7%.*

⚠ WARNING

Altitude diving with hypoxic mixes requires proper acclimatization. Adaptation to lower ppO_2 levels is a slow process requiring your body to produce more red blood cells. The adaptation time is personal and cannot be directly calculated. Desaturation due to pressure drop when arriving at altitude is another factor (see chapter 4.9 Altitude diving).

4.16.2 Gas selection

In technical diving, especially with trimix blends, the decompression efficiency becomes extremely important. Gas mixes with high helium content and low oxygen content are not well-suited for decompression.

For example, where two decompression mixes are, in most cases, enough when air or nitrox is used as a bottom gas, in the case of trimix, optimal off-gassing requires more decompression mixes.

So, the PMG function shall be enabled together with trimix as described in chapter 4.15 Diving with multiple gas mixtures also applies to trimix diving.

Tank 1 is always the starting gas from the surface. When you have set more than one tank, you may change gases during the dive manually or when the A2 suggests it.

The minimum O_2 setting for tank T1 is 18%. This is due to the limitation that a dive must begin with gas 1. To ensure an adequate supply of oxygen to the body, the gas used at the beginning of the dive must contain enough oxygen (you can use a travel mix or one of the decompression gases) as is required for Tank 1.

The minimum O_2 setting for tanks other than tank T1 is 8%.

⚠ WARNING

Heavy work while at the surface or at shallow depths while breathing with less than a 21% oxygen fraction may cause a loss of consciousness and lead to drowning.

⚠ WARNING

Low oxygen fraction settings may allow greater MOD values. The dive computer cannot evaluate your skills, experience or condition to dive the MOD which is showing. Dive only at depths that your certification allows.

The A2 calculates the maximum possible helium fraction by subtracting the oxygen fraction from 100%.

⚠ WARNING

Helium reduces the narcotic effect of the mix, but does not remove it. At great depths, helium may also cause an effect called "helium tremors" or HPNS (High Pressure Nervous Syndrome).

4.17 Setting bookmarks

With a press of the SEL/ESC button you can set any number of bookmarks as reminders of particular moments during the dive. The bookmarks will appear on the dive profile in SCUBAPRO LogTRAK.

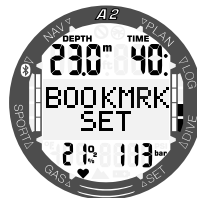

5. INTERFACES FOR THE A2 AND AN INTRODUCTION TO LOGTRAK

5.1 Establishing Bluetooth communication

The A2 can be connected via Bluetooth to a desktop, laptop or handheld device for downloading dive data, configuring dive computer settings or uploading firmware updates.

From the main menu, toggle down to Bluetooth using the +/UP or -/DOWN buttons. Press the SEL/ESC button.

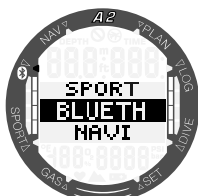

At this point the A2 is ready for Bluetooth communication. Bluetooth is active only when this screen is displayed.

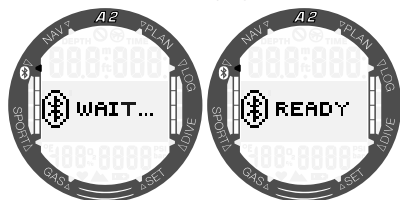

To achieve Bluetooth communication with another device, set the device you want your A2 to communicate with (e.g. an iOS or Android handheld device) to "scanning" mode.

The first time you do this will require entering a pin code to ensure secure communication. This pin code is shown on the A2's screen.

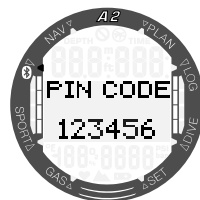

Once the code is accepted by the device you want to connect to, the link is ready for communication.

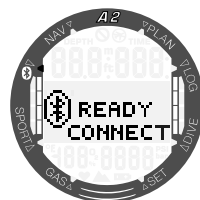

5.2 LogTRAK

LogTRAK is the software that allows the A2 to communicate with various operating systems. LogTRAK is available for Windows, Mac, Android and iOS. In the following section, Windows and Mac versions of LogTRAK are represented. Android and iPhone/iPad versions of LogTRAK operate similarly but do not have all of the features offered in the PC/Mac versions.

5.2.1 Connecting the A2 with LogTRAK

To start the communication using Bluetooth:

1. Pair the A2 with the device where LogTRAK is running.
2. Launch LogTRAK.
3. Check that the A2 is detected by LogTRAK

Extras -> Options -> Download:

Choose "Bluetooth Low Energy" option.

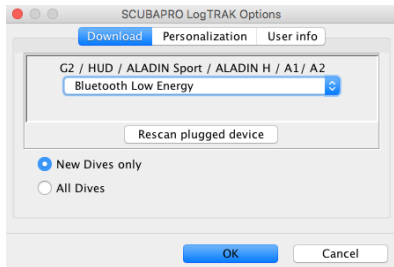

☞ **NOTE:** The A2 has a timeout of 5 minutes for a non-active Bluetooth connection. After this interval the A2 will disable Bluetooth and return to time and date mode.

☞ **NOTE:** Desktop PC's need a generic Bluetooth Low Energy (4.0) dongle, if there is no built in Bluetooth 4.0 or newer module. Windows version below 8.0 and Mac computers require an external Bluegiga BLEDB Bluetooth dongle.

5.2.2 Download dive profiles

From LogTRAK, by selecting **Dive** -> **Download Dives** you can transfer the A2 Logbook to your PC/Mac.

There are 3 main views, each showing a specific part of your dive logs:

1. Profile, showing the graphical data of the dive.
2. Details about the dive, where you can edit, for example, the equipment information.
3. Location, which shows your dive site on the world map.

The selection tabs for views are found along the left side of the main window.

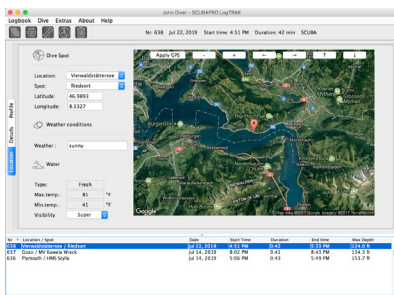
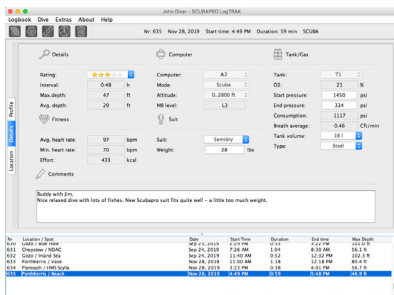
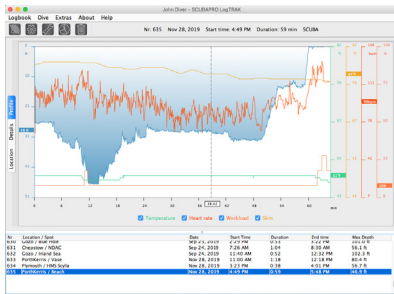

5.2.3 Reading computer information

By selecting **Extras** -> **Read dive computer settings**, you can find general device information for your A2. Dive warnings can be enabled or disabled in this menu by ticking the boxes found on the left section of the "Warning audible" window.

By ticking the box "use PC-Time" and selecting "Write" you can easily update your current time and date.

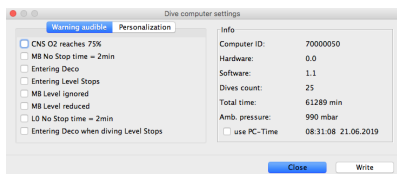

5.2.4 Writing owner information with LogTRAK

Owner information can be registered in the **Extras -> Read dive computer settings-> Personalization** section.

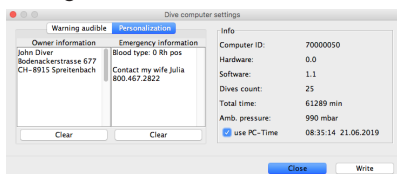

5.2.5 Setting units in LogTRAK

You can set your choice of units in your A2 or on your PC by using the following LogTRAK personalization section:

Extras-> Options-> Personalization

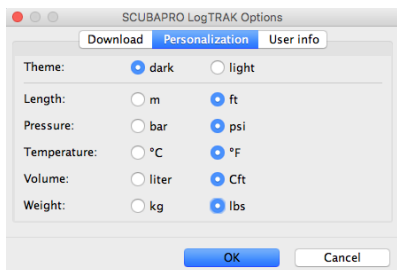

Basic personal details about the user can be shared in the **Extras-> Options-> User info** section.

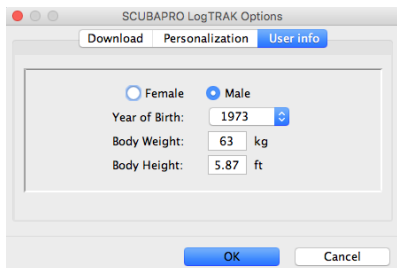

5.2.6 Updating your A2

In order to update the operating software on your A2 dive computer, you need to download the latest software package for your A2 from the SCUBAPRO website and store the .swu file locally.

To perform a software update, select the menu **Firmware upload** from LogTRAK. A file selecting pop-up window will appear. Select the location where you have stored the .swu file.

NOTE: The A2 will check the battery status before the update process. If the battery level is too low, the software update cannot be started. In order to update your A2, the battery must be replaced first.

Once the Bluetooth connection was established and the new software version has been selected, the transfer will start. The A2 shows the transfer status on the display with a progress bar.

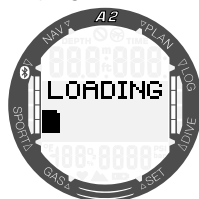

After successful software download the A2 starts the reprogramming automatically.

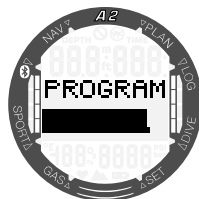

Once the new software has been programmed, the A2 will complete a few internal checks and perform a reboot.



After a successful update the A2 will display the message “Software OK”. This message can be cleared by a short press of the SEL/ESC button. After this your A2 is again ready for normal use.

NOTE: If the A2 detects any problem during the transfer, programming or software checks, an error message will appear on the display. In case of an error, switch off other Bluetooth or WLAN devices from nearby and bring your A2 closer to transmitting device. In case of reoccurring error, check the SCUBAPRO website or contact your local SCUBAPRO service center.

You can check the current software version of your A2 in the menu: **Settings -> User -> Service**. For checking the last service date press the +/UP button and the following screen will be displayed:

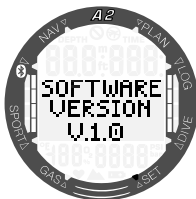

NOTE: LogTRAK doesn't have a firmware upload module in all operating systems, in Android this function looks like in the screenshot below.

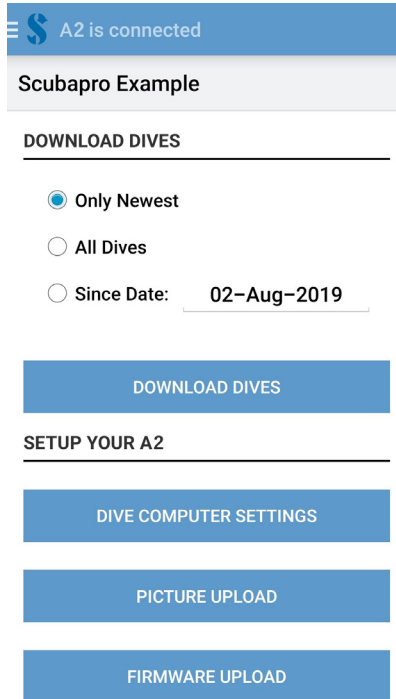

6. A2 ACCESSORIES

6.1 *Wireless high pressure transmitter*

The A2 supports wireless tank pressure using Smart series transmitters. With the PMG function enabled you can use up to 8 transmitters with your A2.

Additional transmitters can be purchased separately from your authorized SCUBAPRO dealer.



 *NOTE: There are 3 generations of Smart transmitters: Smart, Smart+ (longer distance) and Smart+ LED. The A2 is compatible with all of these versions.*

6.2 **SCUBAPRO Heart Rate Belt**

The SCUBAPRO heart rate belt features a patented skin temperature measurement and transmission that is supported by the A2. The proper positioning for wearing a HR belt is shown below. Adjust the strap so that it is comfortable to wear but snug enough so that it stays in place. When wearing a dive suit the HR belt must be directly against the skin. Moisten the electrode areas if your skin is dry or when using a drysuit.

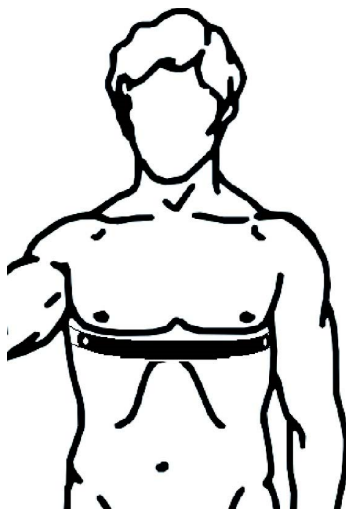

You must enable the heart rate function in your A2. Refer to chapter **3.1.1.1 Workload** for instructions on how to do this.

After a dive rinse the heart rate belt in fresh water, dry it and store it in a dry place.

For HR belts fitted with a battery cap, it is recommended that the battery be changed by an authorized SCUBAPRO dealer.

Check the operating conditions and depth rating of the HR belt from the unit or its user manual.

6.3 Digital Heart Rate Monitor

The new SCUBAPRO Digital Heart Rate Monitor is a wireless heart rate and skin temperature transmitter that forms an integral part of the functionality of a variety of compatible SCUBAPRO dive computers. The heart rate monitor allows you to measure and display heart rate and skin temperature in real time during diving, swimming or exercising.



The heart rate monitor must be paired with your A2 before the first use. After this initial pairing the heart rate monitor will be on standby and ready to send data.

To establish the connection follow the steps below:

Enable the heart rate setting in your A2, by going to the menu **Settings->User->Workload** and selecting **HRT RATE**. In this menu you can also set your base and max HR values.

Remove the heart rate module from the elastic strap by unclipping it from the metal snap fastener.

Go to menu **Settings->User->D-HR belt** in your A2. Make sure your A2 is in close proximity to the digital heart rate monitor when activating the pairing mode.

Place your thumbs on the two metal snap fasteners on the back of the transmitter module and check the indication displayed on your A2's screen.

Once the message "SAVE PAIRING" appears on your A2's display, confirm it by a short press of the SEL/ESC button.

For more information on the operation and maintenance of the new Digital Heart Rate Monitor please refer to its user manual, available at www.scubapro.com/manuals.

6.4 Watch straps

The A2 is compatible with a variety of different types of watch straps - like the NATO style straps, stainless steel straps, soft silicone straps and rubber straps - available to buy separately from your nearest SCUBAPRO dealer.



7. TAKING CARE OF YOUR A2

7.1 Changing the watch strap

The watch straps of the A2 can be removed and replaced by unscrewing the Torx screws at the corners of the watch body.



Different types of watch straps are available, like the nylon NATO type strap, linked metal strap and swiveled silicon strap.

7.2 Display protection foil

You can protect your A2's glass face with a SCUBAPRO display guard. This foil can be easily replaced if damaged.



NOTE: If air bubbles get stuck underneath the protection foil when placing it on your A2's glass face, do not try to remove them as the water pressure will eliminate them after the first dive.

7.3 Technical information

Operating altitude:

Sea level to approximately
4000m/13300ft.

Max operating depth:

120m/394ft; resolution is 0.1m until
99.9m, and 1m at depths deeper than
100m. Resolution in feet is always 1ft.
Accuracy complies with EN13319 and
ISO 6425.

Decompression calculation range:

0.8m to 120m / 3ft to 394ft.

Clock:

Quartz clock; time, date, dive time
displays up to 99 minutes and 59
seconds, and in minute steps up to
999 minutes.

Oxygen concentration:

Adjustable between 8% and 100%.

Helium concentration:

Adjustable between 0% and 92%.

Operating temperature:

-10C to +50C / 14F to 122F.

Power supply:

Lithium type CR2450 battery.

Operation time with a fresh battery:

Up to 2 years. Actual battery operation
time depends primarily on the
operational temperature and backlight
settings, but also on many other
factors.

Bluetooth® transceiver:

Operating frequency 2402-2478 MHz,
max power < 3 dBm, connection
range approx. 2m.

7.4 Maintenance

The A2's depth accuracy should be verified
every 2 years by an authorized SCUBAPRO
dealer. The last service date can be
checked from the main menu: **Settings ->**
User -> Service.

The tank pressure gauge and the parts of
this product used to measure tank pressure
should be serviced by an authorized
SCUBAPRO dealer every other year, or
after 200 dives (whichever comes first).

Aside from that, the A2 is virtually
maintenance-free. All you need to do is
rinse it carefully with fresh water after each
dive and change the battery when needed.
To avoid possible problems with your A2,
the following recommendations will help
assure years of trouble-free service:

- Avoid dropping or jarring your A2.
- Do not expose your A2 to intense, direct
sunlight.
- Do not store your A2 in a sealed
container; always ensure free ventilation.
- If there are problems with the water
contacts, use soapy water to clean your
A2 and dry it thoroughly.
- Do not use silicone grease on the water
contacts!
- Do not clean your A2 with liquids
containing solvents.
- Check the battery capacity before each
dive.
- If the battery warning appears, have
the battery replaced by an authorized
SCUBAPRO dealer.
- If any error message appears on
the display, take your A2 back to an
authorized SCUBAPRO dealer.

7.5 Replacing the battery in the high pressure transmitter

The following parts of the transmitter are shown in the drawing below:

1. Transmitter cap screws.
2. HP port O-ring.
3. Main O-ring.
4. CR 2/3 AA battery.
5. Transmitter cap.

To change the battery in the high-pressure transmitter:

1. Dry the transmitter with a soft towel.
2. Open the screws.
3. Replace the main O-ring (replacement rings are available from your authorized SCUBAPRO dealer).
4. Remove the empty battery and recycle it in an environmentally friendly way.
5. Insert the new battery. Note the polarity, "+" is marked on the body. Do not touch to poles or contacts with bare fingers.
6. Close the screws.
7. Check the transmitter function and housing sealing.



7.6 Replacing the battery in the SCUBAPRO Heart Rate Belt

The following parts of the Heart Rate Belt are shown in the drawing below:

1. Battery cap
2. O-ring
3. CR2032
4. Heart Rate Belt body

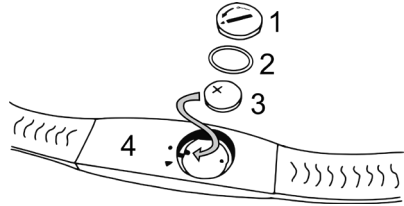

To change the battery in the Heart Rate Belt:

1. Dry the Heart Rate Belt with a soft towel.
2. Open the battery cap.
3. Replace the main O-ring (replacement O-rings are available from your authorized SCUBAPRO dealer).
4. Remove the empty battery and recycle it in an environmentally friendly way.
5. Insert the new battery. Note the polarity, "+" is marked on the body. Do not touch to poles or contacts with bare fingers.
6. Close the battery cap. (Note the correct closing position mark).
7. Check the Heart Rate Belt function and housing sealing.

7.7 Replacing the battery in the Digital Heart Rate Monitor

The digital heart rate monitor is powered by a user-replaceable CR2032 type lithium battery. However, in order to avoid leakage by incorrect closure of the battery cap, we recommend having the battery replaced by an authorized SCUBAPRO dealer.

The following parts of the heart rate monitor are shown in the drawing below:

1. battery cap screws
2. battery cap
3. O-ring
4. CR2032 battery
5. heart rate monitor module

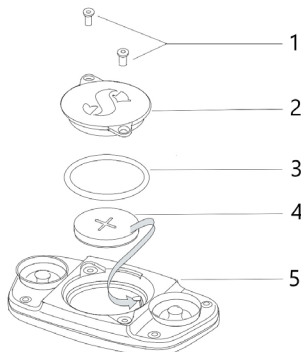

To change the battery in the heart rate monitor:

- Dry the module of the heart rate monitor with a soft towel if wet
- Open the battery cap by removing the screws
- Replace the O-ring (replacement O-rings are available from your authorized SCUBAPRO dealer)
- Remove the empty battery and recycle it in an environmentally friendly way
- Insert the new battery. Note the polarity, “+” is marked on the body. Do not touch poles or contacts with bare fingers
- Close the battery cap

7.8 Warranty

The A2 has a 2-year warranty covering defects in workmanship and functioning. The warranty only covers dive computers which have been bought from an authorized SCUBAPRO dealer. Repairs or replacements during the warranty period do not extend beyond the warranty period itself.

Excluded from warranty coverage are faults or defects due to:

1. Excessive wear and tear.
2. Exterior influences, e.g. transport damage, damage due to bumping and hitting, influences of weather or other natural phenomena.
3. Servicing, repairs or the opening of the dive computer by anybody not authorized to do so by the manufacturer.
4. Pressure tests which do not take place in water.
5. Diving accidents.
6. Opening the A2 housing.
7. Commercial use.
8. Exposing the unit to chemicals which include but are not limited to mosquito repellents and sunscreen.
9. Repairing with unauthorized spare parts.
10. Using any software or accessory which is not supplied by the manufacturer.

For European Union markets, the warranty of this product is governed by European legislation in force in each EU member state.

All warranty claims must be returned with dated proof-of-purchase to an authorized SCUBAPRO dealer. Visit www.scubapro.com to locate your nearest dealer.

8. COMPLIANCE

8.1 CE regulatory notices



8.1.1 EU Radio Equipment Directive

Hereby, Uwatec AG, declares that the radio equipment type PAN1740 is in compliance with Directive 2014/53/EU.

8.1.2 EU Personal Protective Equipment Regulation

The combination of SCUABPRO A2 and SCUBAPRO high pressure transmitter is a personal protective equipment in compliance with the essential safety requirements of the EU Regulation 2016/425. The notified body no.0474, RINA SpA, Via Corsica 12, I-16128 Genoa, has completed the EC type-examination to the combination mentioned above and assured the conformity with the European Standard EN250:2014. The certification is up to a depth of 50m as defined in the EN250:2014.

8.1.3 EU Depth Gauge Standard

The A2 dive instrument is also compliant with the European standard EN 13319:2000 (EN 13319:2000 – Depth gauges and combined depth and time measuring devices – Functional and safety requirements, test methods).

8.1.4 EU Electromagnetic Compatibility Directive

The A2 dive instrument is also compliant with the European Union directive 2014/30/EU.

8.1.5 EU declaration of conformity

The full text of the EU declaration of conformity is available at www.scubapro.com/declarations-conformity

8.2 FCC & ISED regulatory notices

8.2.1 Modification Statement

Uwatec has not approved any changes or modifications to this device by the user. Any changes or modifications could void the user's authority to operate the equipment.

8.2.2 Interference Statement

This device complies with Part 15 of the FCC Rules and Industry Canada license-exempt RSS standard(s). Operation is subject to the following two conditions: (1) this device may not cause interference, and (2) this device must accept any interference, including interference that may cause undesired operation of the device.

8.2.3 Wireless Notice

This device complies with FCC/ISED radiation exposure limits set forth for an uncontrolled environment and meets the FCC radio frequency (RF) Exposure Guidelines and RSS-102 of the ISED radio frequency (RF) Exposure rules. This transmitter must not be co-located or operated in conjunction with any other antenna or transmitter.

The A2 contains TX FCC ID: T7V1740.

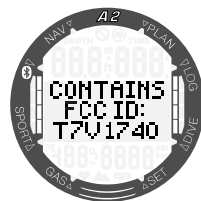

8.2.4 FCC Class B Digital Device Notice

This equipment has been tested and found to comply with the limits for a Class B digital device, pursuant to part 15 of the FCC Rules. These limits are designed to provide reasonable protection against harmful interference in a residential installation. This equipment generates, uses and can radiate radio frequency energy and, if not installed and used in accordance with the instructions, may cause harmful interference

to radio communications. However, there is no guarantee that interference will not occur in a particular installation. If this equipment does cause harmful interference to radio or television reception, which can be determined by turning the equipment off and on, the user is encouraged to try to correct the interference by one or more of the following measures:

1. Reorient or relocate the receiving antenna.
2. Increase the separation between the equipment and receiver.
3. Connect the equipment into an outlet on a circuit different from that to which the receiver is connected.
4. Consult the dealer or an experienced radio/TV technician for help.

8.2.5 CAN ICES-3 (B) / NMB-3 (B)

This Class B digital apparatus complies with Canadian ICES-003.

8.3 Date of manufacture

The manufacturing date can be determined from your device's serial number. The serial number is always 13 characters long: YYMMDDXXXXXX.

In the serial number the first two digits (YY) represent the year, the third and fourth (MM) the month, and the fifth and sixth (DD) the day when the device was manufactured.

8.4 Manufacturer

UWATEC AG
 Bodenackerstrasse 3
 CH-8957 Spreitenbach
 SWITZERLAND



Your dive instrument is manufactured with high-quality components that can be recycled and reused. Nevertheless, these components, if not properly managed in accordance with the regulations on electrical and electronic equipment waste, are likely to cause harm to the environment and/or to human health. Customers living in the European Union can contribute to protecting the environment and health by returning old products to an appropriate collection point in their neighborhood in accordance with EU Directive 2012/19/UE. Collection points are provided by some distributors of the products and local authorities. Products marked with the recycling symbol on the left must not be disposed of in normal household waste.

9. GLOSSARY

AMD	Absolute Minimum Depth, the depth where a mix can be started to be used based on its oxygen content
AVG	Average Depth. Calculated from the beginning of the dive or from the time of reset.
CCR	Closed Circuit Rebreather. A breathing device that absorbs the carbon dioxide of a diver's exhaled breath to permit the recycling, or "rebreathing," of the unused oxygen content of each breath.
CNS O ₂	Central Nervous System Oxygen toxicity.
DESAT	Desaturation Time. The time needed for the body to completely eliminate any nitrogen taken up during diving.
Dive Time	The time spent below a depth of 0.8m/3ft.
Gas	Refers to the main gas that is set for the ZH-L16 ADT MB PMG algorithm.
Local Time	Current time in the local time zone.
Max Depth	Maximum depth attained during the dive.
MB	Microbubbles: Microbubbles are tiny bubbles that can build up in a diver's body during and after a dive.
MB-level	One of 9 levels (L0-L9), provided by the A2's ZH-L16 ADT MB PMG algorithm.
MOD	Maximum Operating Depth. This is the depth at which the partial pressure of oxygen (ppO ₂) reaches the maximum allowed level (ppO ₂ max). Diving deeper than the MOD will expose the diver to unsafe ppO ₂ levels.
Nitrox	A breathing mix made of oxygen and nitrogen, with the oxygen concentration being 22% or higher.
NO FLY	Minimum amount of time a diver should wait before flying.
No-Stop Time	The amount of time a diver can stay at the current depth and still make a direct ascent to the surface without having to perform decompression stops.
O ₂	Oxygen.
O ₂ %	Oxygen concentration used by the A2 in all calculations.
PDIS	Profile Dependent Intermediate Stop is an additional deep stop which is suggested by the A2 at a depth where the 5th, 6th or 7th compartment starts off-gassing.
PMG	Predictive Multi-gas. Lets you carry additional breathing gases in addition to your main breathing gas.
ppO ₂	Partial pressure of oxygen. This is the pressure of the oxygen in the breathing mix. It is a function of depth and oxygen concentration. A ppO ₂ higher than 1.6bar is considered dangerous.
ppO ₂ max	The maximum allowed value for ppO ₂ . Together with the oxygen concentration, it defines the MOD.

Press-and-hold	The act of pressing-and-holding the button for 1 second before releasing.
RBT	Remaining Bottom Time. The time you can spend at the current depth and still have enough gas supply to make a safe ascent and reach the surface with the tank reserve.
Sidemount	Practice of diving with two or more cylinders secured at the sides of the body in line with the torso and without cylinders on the diver's back.
SOS Mode	The result of having completed a dive without respecting all mandatory decompression obligations.
SURF INT	Surface interval. The time that starts at the moment the dive is closed out.
Switch Point	The depth at which the diver plans to switch to a different oxygen mix while using the multi-gas option.
TAT	Total Ascent Time.
Trimix	A gas mixture containing Oxygen, Helium and Nitrogen
UTC	Universal Time Coordinated. This is the primary time standard used worldwide to regulate clocks and time. UTC correlates to your location's time zone through the use of offsets ranging from -12 to +14 hours.

